

Autodesk Storm and Sanitary Analysis Stand-Alone 2011

User's Guide

Autodesk®

April 2010

© 2010 Autodesk, Inc. All Rights Reserved. Except as otherwise permitted by Autodesk, Inc., this publication, or parts thereof, may not be reproduced in any form, by any method, for any purpose.

Certain materials included in this publication are reprinted with the permission of the copyright holder.

Trademarks

The following are registered trademarks or trademarks of Autodesk, Inc., in the USA and other countries: 3DEC (design/logo), 3December, 3December.com, 3ds Max, ADI, Alias, Alias (swirl design/logo), AliasStudio, Alias|Wavefront (design/logo), ATC, AUGI, AutoCAD, AutoCAD Learning Assistance, AutoCAD LT, AutoCAD Simulator, AutoCAD SQL Extension, AutoCAD SQL Interface, Autodesk, Autodesk Envision, Autodesk Insight, Autodesk Intent, Autodesk Inventor, Autodesk Map, Autodesk MapGuide, Autodesk River Analysis, Autodesk Storm and Sanitary Analysis, Autodesk Streamline, Autodesk Water Analysis, AutoLISP, AutoSnap, AutoSketch, AutoTrack, Backdraft, Built with ObjectARX (logo), Burn, Buzzsaw, CAiCE, Can You Imagine, Character Studio, Cinestream, Civil 3D, Cleaner, Cleaner Central, ClearScale, Colour Warper, Combustion, Communication Specification, Constructware, Content Explorer, Create>what's>Next> (design/logo), Dancing Baby (image), DesignCenter, Design Doctor, Designer's Toolkit, DesignKids, DesignProf, DesignServer, DesignStudio, DesignStudio (design/logo), Design Web Format, Discreet, DWF, DWG, DWG (logo), DWG Extreme, DWG TrueConvert, DWG TrueView, DXF, Ecotect, Exposure, Extending the Design Team, Face Robot, FBX, Filmbox, Fire, Flame, Flint, FMDesktop, Freewheel, Frost, GDX Driver, Gmax, Green Building Studio, Heads-up Design, Heidi, HumanIK, IDEA Server, i-drop, ImageModeler, iMOUT, Incinerator, Inferno, Inventor, Inventor LT, Kaydara, Kaydara (design/logo), Kynapse, Kynogon, LandXplorer, LocationLogic, Lustre, Matchmover, Maya, Mechanical Desktop, Moonbox, MotionBuilder, Movimento, Mudbox, NavisWorks, ObjectARX, ObjectDBX, Open Reality, Opticore, Opticore Opus, PolarSnap, PortfolioWall, Powered with Autodesk Technology, Productstream, ProjectPoint, ProMaterials, RasterDWG, Reactor, RealDWG, Real-time Roto, REALVIZ, Recognize, Render Queue, Retimer,Reveal, Revit, Showcase, ShowMotion, SketchBook, Smoke, Softimage, Softimage|XSI (design/logo), SteeringWheels, Stitcher, Stone, StudioTools, Topobase, Toxik, TrustedDWG, ViewCube, Visual, Visual Construction, Visual Drainage, Visual Landscape, Visual Survey, Visual Toolbox, Visual LISP, Voice Reality, Volo, Vtour, Wire, Wiretap, WiretapCentral, XSI, and XSI (design/logo).

The following are registered trademarks or trademarks of Autodesk Canada Co. in the USA and/or Canada and other countries: Backburner, Multi-Master Editing, River, and Sparks.

The following are registered trademarks or trademarks of MoldflowCorp. in the USA and/or other countries: Moldflow, MPA, MPA (design/logo), Moldflow Plastics Advisers, MPI, MPI (design/logo), Moldflow Plastics Insight, MPX, MPX (design/logo), Moldflow Plastics Xpert.

All other brand names, product names or trademarks belong to their respective holders.

Disclaimer

THIS PUBLICATION AND THE INFORMATION CONTAINED HEREIN IS MADE AVAILABLE BY AUTODESK, INC. "AS IS." AUTODESK, INC. DISCLAIMS ALL WARRANTIES, EITHER EXPRESS OR IMPLIED, INCLUDING BUT NOT LIMITED TO ANY IMPLIED WARRANTIES OF MERCHANTABILITY OR FITNESS FOR A PARTICULAR PURPOSE REGARDING THESE MATERIALS.

Published By: Autodesk, Inc.
111 McInnis Parkway
San Rafael, CA 94903, USA

Contents

Chapter 1	Overview	1
	Capabilities	1
	Typical Applications	1
	AutoCAD Support	1
	Easy Model Development	2
	Network Modeling Elements	3
	Advanced Output	3
	Report Generator	3
	GIS Support	4
	Model Checker	4
	Hydrology Modeling Capabilities	4
	Rainfall Designer	5
	Hydraulic Modeling Capabilities	5
	Interconnected Detention Pond Modeling	7
	Underground Stormwater Detention and Infiltration	8
	Infiltration Basins	8
	Highway Drainage Design	8
	Water Quality Modeling Capabilities	9
	NPDES	9
	Sanitary Sewer Modeling Capabilities	9
Chapter 2	Getting Started	11
	User Interface Basics	11
	Plan View	11
	Menu Bar	13
	Data Tree	14
	Toolbars	14
	Status Bar	16
	View Tabs	17
	Input Data Dialog Boxes	17
	Program Options	19

Plan View Features	20
Standard Toolbar	20
Map Toolbar	21
<i>Select Element Tool</i>	21
<i>Edit Vertices Tool</i>	21
<i>Select Polygon Tool</i>	22
<i>Measure Distance Tool</i>	22
<i>Measure Area Tool</i>	23
<i>Zoom Tool</i>	23
<i>Zoom Previous Tool</i>	23
<i>Zoom Extents Tool</i>	24
<i>Pan Tool</i>	24
<i>Lock Coordinates</i>	24
Elements Toolbar	24
Output Toolbar	25
Display Options	25
<i>Elements</i>	26
<i>Subbasins</i>	26
<i>Nodes</i>	27
<i>Links</i>	27
<i>Symbols</i>	28
<i>Labels</i>	28
<i>Arrows</i>	28
<i>Plan View</i>	29
<i>Annotation</i>	29
<i>Properties</i>	29
<i>Legends</i>	31
Right-Click Context Menu	34
Aerial View	35

Chapter 3 Defining a Network 37

Model Representation	37
Network Subbasin Elements	38
Network Node Elements	39
Network Link Elements	39
Network Routing	39
Multiple Networks	39
Defining a Network Model	40
Schematic Network vs. Mapped Network	42
Typical Steps in Building a Network Model	42
Defining a Subbasin	42
Defining a Node	43
Defining a Link	44
Defining a Rain Gage	46
Adding Map Labels	49
Editing Map Labels	49
<i>Moving a Map Label</i>	50
<i>Copying Map Label Formatting</i>	50
Adding Non-Visual Input Data	50
Selecting and Moving Elements	51
Editing Node Coordinates	52

Editing Network Elements	53
Selecting and Editing an Element.	53
Converting Elements to Other Element Types	53
Duplicating Network Elements.	55
Copying and Pasting Element Properties	55
Reshaping Network Elements.	57
Reversing a Network Element Direction	59
Finding Elements	61
Querying Elements	62
Editing Multiple Elements	64
Deleting Multiple Elements	66
Network Transformation	67
Chapter 4 Network Analysis	69
Analysis Options	69
General	69
<i>Time Steps</i>	70
<i>Dates</i>	71
<i>Analysis Computations</i>	72
<i>Hydrodynamic Analysis Parameters</i>	73
<i>Read/Write External Interface Files</i>	74
Storm Selection	76
<i>Single Storm Analysis</i>	76
<i>Multiple Storm Analysis</i>	78
Combining Routing Interface Files	80
RDII and Routing File Format	82
Performing an Analysis.	82
Saving Analysis Results.	84
<i>Multiple Storm Analysis</i>	85
Water Quality Routing	85
Troubleshooting a Model.	85
Analysis Warning and Error Messages.	89
Warning Messages.	89
Error Messages	95
Chapter 5 Display Analysis Results	107
Output Variables	107
Loading Previous Analysis Results	108
Input Dialog Boxes.	109
Output Animation	110
Animation Control Keyboard Commands	111
Recording Animations	112
ASCII Output Report	113
Copying to Clipboard	114
Finding an Element on the Plan View.	114
Analysis Results Bookmark Navigation	114
Report Sections	114

Custom Reports	116
General Options	117
Header & Footer Tab	117
Report Sections Tab	118
Individual Elements Tab	118
Saving a Report Template	119
Loading a Report Template	119
Default Report Template	119
Generating a Report	119
Excel Table Reports	120
Viewing Results on Plan View	120
Property Mapping	120
Simulation Date & Time	122
Flyover Property Labeling	122
Nodal Mapping	123
Querying	124
Animating	124
Printing, Copying, and Exporting	125
Profile Plots	125
Redefining the Profile Path	128
Saving the Current Profile Path	129
Loading a Previously Defined Profile Path	130
Right-Click Context Menu	131
Customizing the Profile Plot	132
Summary Table Section	133
Zooming and Panning	136
Animating	136
Printing, Copying, and Exporting	137
CAD Exporting	138
Automatic Updating of Plots	139
Calculation of Energy Grade Line (EGL)	139
Interpretation of HGL and EGL	139
Time Series Plots	140
Output Variable Tree	140
Subbasin Output Variables	141
Node Output Variables	142
Link Output Variables	142
System Output Variables	143
Creating a Time Series Plot	143
Displaying Multiple Time Series Plots	145
Comparing Different Simulation Results	146
Summary Table Section	148
Computing Detention Pond Minimum Storage Volumes	149
Data Table	151
Right-Click Context Menu	153
Time Series Plot Customization	154
Legend Location	154
Zooming and Panning	155
Printing, Copying, and Exporting	155
Automatic Updating of Plots	155

Time Series Tables	156
Time Series Table by Element	156
Time Series Table by Variable	156
Creating a Time Series Table by Element	157
Creating a Time Series Table by Variable	158
Printing, Copying, and Exporting	159
Automatic Updating of Tables	160
Statistical Reports	160
Creating a Statistics Report	161
Chapter 6 General Data	163
Project Description	163
Project Options	163
General	163
<i>Units & Element Specifications</i>	165
<i>Hydrology Runoff Specifications</i>	166
<i>Hydraulic Routing Specifications</i>	174
<i>Computational & Reporting Options</i>	176
<i>Disabling Hydrology, Hydraulics, and Other Computations</i>	178
<i>Hydrology Method Limitations</i>	178
<i>Specialized Hydrology Modeling</i>	179
ID Labels	180
Element Prototypes	182
Chapter 7 Network Element Data	187
Channel, Pipe & Culvert Links	187
Analysis Summary Section	198
Junction Losses vs. Entrance & Exit Losses	201
FHWA Culvert Computations	205
<i>Inlet Control Computations</i>	205
<i>Outlet Control Computations</i>	206
User-Defined Cross Sections	206
Invert Elevations or Offsets	206
Inflow and Outflow Pipe Invert Elevations	206
Globally Assigning Link Invert Elevations	207
Minimum Flow Velocity and Pipe Grades	208
Hydraulic Head Losses	208
Minimum and Maximum Pipe Cover	208
Storm Sewer Pipe Alignment	209
Storm Drain Run Lengths	209
Adverse Slope	209
Surcharged Pipes and Oscillations	210
Custom Pipe Geometry	210
Right-Click Context Menu	211
Importing and Exporting Custom Pipe Geometry Data	211
Irregular Cross Sections	211
Right-Click Context Menu	213
Irregular Cross Section Elevations	214
Extended Stream Reaches	214

Junctions	214
Globally Assigning Node Invert Elevations	218
Surface Ponding	218
Analysis Summary Section	219
Modeling Storage Vaults and Other Nodal Storage Structures	220
Location and Spacing	220
Access Hole Depth	221
Junction Head Losses	221
Minimizing Flow Turbulence in Junctions	222
Junction Access Hole Design	223
Bolted (Sealed) Manhole Covers	224
Storm Drain Inlets	224
Storm Drain Inlet Types	225
Inlet Characteristics and Uses	227
Hydraulics of Storm Drain Inlets	227
Multiple Drainage Pathways	230
Inlets Dialog Box	231
Additional Input Data	239
Analysis Summary Results	239
Inlet Hydraulic Performance Curves	240
Design Storm Frequency	241
Time of Concentration for Inlet Spacing and Pipe Sizing	242
Storm Drain Inlet Sizing, Spacing, and Locating	243
On Sag Storm Drain Inlets	245
Unit Conversion Problems	246
Flow Diversions	246
Analysis Summary Section	252
Flow Diversion Structure Design	252
Flow Diversion Curves	253
Right-Click Context Menu	254
Importing and Exporting Flow Diversion Curve Data	255
Unit Conversion Problems	255
Outfalls	255
Analysis Summary Section	258
Outfall Tidal Curves	258
Right-Click Context Menu	259
Importing and Exporting Tidal Curve Data	260
Pumps	260
Control Rules	264
Pump Curves	264
Right-Click Context Menu	267
Importing and Exporting Pump Curve Data	267
Unit Conversion Problems	267

Chapter 8	Storage Element Data	269
	Storage Nodes	269
	Flow Properties Data	271
	Storage Shape Data	272
	Exfiltration Data	273
	<i>Constant Flow Rate Exfiltration Method Data</i>	274
	<i>Constant Rate Exfiltration Method Data</i>	274
	<i>Horton Exfiltration Method Data</i>	274
	Analysis Summary Section	276
	Infiltration Basin Considerations	277
	Underground Storage Facilities	278
	Non-Standard Junctions	279
	Minimum Drain Time	279
	Estimating First Flush Volume	281
	Storage Curves	281
	On-Site Underground Detention/Retention	282
	Storage Curve Data	283
	<i>Underground Storage Pipes</i>	284
	<i>Underground Storage Arch Pipes</i>	286
	<i>Underground Storage Chambers</i>	288
	<i>Depth vs. Area Storage Curve Data</i>	291
	<i>Depth vs. Volume Storage Curve Data</i>	292
	<i>Unique Elevation Values Required</i>	292
	<i>Importing and Exporting Storage Curve Data</i>	292
	Right-Click Context Menu	292
	Orifices	292
	Analysis Summary Section	297
	Controllable Gates and Valves	298
	Complex Discharge Structures	298
	Flow Reversals	298
	Outlets	298
	Analysis Summary Section	301
	Tailwater Submergence Effects	302
	Controllable Outlets	302
	Vortex Flow Control Devices	302
	Outlet Rating Curves	304
	Right-Click Context Menu	305
	Importing and Exporting Outlet Rating Curve Data	306
	Unit Conversion Problems	306
	Spillways and Weirs	306
	Analysis Summary Section	314
	Submerged Weir Flow	314
	Roadway Overflow Routing	314
	Controllable Inflatable Weirs and Rubber Dams	315
	Composite Weir Structures	315
	Complex Discharge Structures	316

Chapter 9	Subbasin Element Data	317
	Subbasins	317
	Subbasins Dialog Box	318
	Physical Properties Tab	320
	<i>Analysis Summary Section</i>	326
	SCS TR-55 Curve Numbers	328
	<i>Curve Number Tab</i>	328
	<i>Editing & Customizing the Curve Number Table</i>	330
	Runoff Coefficients	331
	<i>Runoff Coefficient Tab</i>	332
	<i>Editing & Customizing the Runoff Coefficient Table</i>	333
	SCS TR-55 TOC Method	334
	<i>SCS TR-55 TOC Tab</i>	334
	<i>SCS TR-55 TOC Sheet Flow Tab</i>	337
	<i>SCS TR-55 TOC Shallow Concentrated Flow Tab</i>	338
	<i>SCS TR-55 TOC Channel Flow Tab</i>	341
	EPA SWMM Hydrology Method	343
	<i>Flow Properties Tab</i>	343
	<i>EPA SWMM Time of Concentration Method</i>	351
	<i>EPA SWMM Hydrology</i>	353
	HEC-1 Hydrology Method	355
	<i>Physical Properties Tab</i>	356
	<i>Base Flow</i>	356
	<i>Uniform Loss Method</i>	360
	<i>SCS Curve Number Loss Method</i>	361
	<i>Exponential Loss Method</i>	363
	<i>Green Ampt Loss Method</i>	365
	<i>Holtan Loss Method</i>	367
	<i>Clark Unit Hydrograph Method</i>	369
	<i>SCS Dimensionless Unit Hydrograph Method</i>	375
	<i>Snyder Unit Hydrograph Method</i>	376
	<i>User Defined Unit Hydrograph Method</i>	377
	<i>Kinematic Wave Method</i>	379
	<i>HEC-1 Flood Routing</i>	386
	<i>Exporting HEC-1 Input Data Files</i>	386
	Subbasin Delineation	387
	Rain Gages	388
	Directly Assigning Storm Precipitation	391
	Rational Method, Modified Rational, DeKalb Rational Methods	391
	SCS TR-55 and SCS TR-20 Hydrology Methods	391
	External Rainfall Files	391
	Rainfall Designer	392
	SCS Rainfall Distributions	395
	Huff Rainfall Distributions	397
	Saving a Design Storm	397
	IDF Curves	398
	Default Intensity Duration Frequency Data	401
	Saving Intensity Duration Frequency Data	402

External Inflows	402
Rainfall-Dependent Infiltrations/Inflows (RDII)	403
User-Defined (Direct) Inflows	403
Dry Weather (Sanitary) Inflows	404
Typical Daily Average Flows	405
External Inflows for Node	408
Rainfall-Dependent Infiltrations/Inflows (RDII)	408
User-Defined (Direct) Inflows	409
Dry Weather (Sanitary) Inflows	410
RDII Unit Hydrographs	411
RTK Unit Hydrograph Parameters	414
Initial Abstraction Parameters	414
Sources of RDII	415
RDII Parameter Determination and Calibration	416
<i>Model Validation Criteria</i>	417
<i>Flow Monitoring and Measurements</i>	417
<i>Routing Method Selection</i>	418
<i>Computational Time Steps</i>	418
<i>RDII Determination for Large Network Systems</i>	418
<i>Initial RDII Parameters</i>	419
<i>Calibration Steps</i>	419
<i>Extrapolating Calibrated Model Concerns</i>	421
<i>Additional RDII References</i>	421
Dimensionless Unit Hydrograph	421
Groundwater Aquifers	425
Groundwater Aquifer Assignment	428
Flow Coefficient Units	430
Proportional Groundwater Flow	430
Negative Groundwater Flux	431
Snow Packs	431
Snow Pack Parameters	433
Snow Removal Parameters	434
Snow Depths	434
Chapter 10 Other Data	437
Climatology	437
Temperature Data	437
Evaporation Data	438
Wind Speed Data	439
Snow Melt Data	440
Areal Depletion Data	441
External Climate File	442
Control Rules	442
Control Rule Format	443
<i>Condition Clauses</i>	444
<i>Action Clauses</i>	445
Modulated Controls	445
<i>PID Controllers</i>	446
Conditional Rule Examples	447

Control Settings	448
Right-Click Context Menu	449
Importing and Exporting Control Setting Data	450
Pollutants	450
Co-Pollutant Example	453
Pollutants Land Types	453
General	454
Street Sweeping	454
Pollutant Buildup	455
<i>Power Function</i>	455
<i>Exponential Function</i>	456
<i>Saturation Function</i>	456
Pollutant Washoff	457
<i>Exponential Function</i>	458
<i>Rating Curve Function</i>	458
<i>Event Mean Concentration Function</i>	458
<i>Pollutant Washoff Function Plots</i>	460
Pollutants	460
Pollutant Land Type Assignment	460
Initial Pollutants	461
Units	462
Computed Initial Buildup	462
Pollutant Treatments	462
TSS Removal Example	464
Sanitary Time Patterns	464
Demand Pattern Summary	466
Recommended Unit Multiplier Average	466
Right-Click Context Menu	467
Time Series	467
Time & Date Formats	468
Right-Click Context Menu	468
Rainfall Time Series Data	468
Extrapolation of Time Series Data	469
Microsoft Excel Data	469
Importing and Exporting Time Series Data	469
Time Series File Format	470

Chapter 11 Importing and Exporting 471

Supported File Formats	471
Importing and Exporting AutoCAD Drawings	471
Importing AutoCAD Drawings	472
<i>Drawing Layer Control</i>	472
<i>Importing Multiple Drawings</i>	473
<i>Link to Original Drawing File</i>	473
<i>Unloading a Drawing File</i>	473
Exporting AutoCAD Drawings	473

Importing Background Map & Orthophoto Images	474
Geo-Referenced Images	474
Coordinate Transformation	474
Importing Multiple Image Files	475
Link to Original Image File	475
Unloading an Image File	475
Watermark Display of Image	475
Image and Network Coordinates	475
Units for Digitizing	475
Exporting Windows Metafiles	475
Importing & Exporting Hydraflow Storm Sewers Files	476
Importing Hydraflow Storm Sewers Files	476
Hydraflow Import Considerations	478
Exporting Hydraflow Storm Sewers Files	479
Hydraflow Export Considerations	480
Importing & Exporting LandXML Files	481
Importing a LandXML File	481
Exporting a LandXML File	482
Importing & Exporting GIS Shapefiles	482
Importing GIS Shapefiles	483
Exporting GIS Shapefiles	486
Importing & Exporting EPA SWMM Input Data Files	489
Importing EPA SWMM Input Data Files	489
Exporting EPA SWMM Input Data Files	490
Importing & Exporting XPSWMM Input Data Files	491
Importing XPSWMM Input Data Files	491
Exporting XPSWMM Input Data Files	493
Exporting Network Coordinate Data	494
Merging Network Models	494
Microsoft Excel Spreadsheets	495
Importing Excel Spreadsheet Data	495
Exporting Excel Spreadsheets	495
Index	497

Overview

1

Autodesk® Storm and Sanitary Analysis is an advanced, powerful, and comprehensive modeling package for analyzing and designing urban drainage systems, stormwater sewers, and sanitary sewers.

Capabilities

The software can simultaneously model complex hydrology, hydraulics, and water quality. Both US units and SI metric units are supported.

This software can be used for designing and analyzing:

- Highway drainage systems (including curb and gutter inlets)
- Stormwater sewer networks and interconnected detention ponds
- Subdivision drainage systems
- Sizing and designing of detention ponds and outlet structures
- Bridge and culverts, including roadway overtopping
- Water quality studies
- Sanitary sewers, lift stations, CSO's, and SSO's

Typical Applications

The software has been used in thousands of sewer and stormwater studies throughout the world. Typical applications include:

- Design and sizing of drainage system components for flood control
- Design and sizing of detention facilities for flood control and water quality protection
- Floodplain mapping of natural channel systems
- Designing control strategies for minimizing combined sewer overflows (CSO)
- Evaluating the impact of inflow and infiltration on sanitary sewer overflows (SSO)
- Generating non-point source pollutant loadings for waste load allocation studies
- Evaluating the effectiveness of BMPs for reducing wet weather pollutant loadings

AutoCAD Support

Autodesk Storm and Sanitary Analysis easily shares data with AutoCAD Civil 3D® and AutoCAD Map 3D®. Using Hydraflow Storm Sewers or LandXML files, the software can share subbasin, sewer pipe, and structure entity data with AutoCAD Civil 3D. Using GIS shapefiles, the software can share subbasin, sewer pipe, and structure entity data with AutoCAD Map 3D.

In addition, AutoCAD drawings can be loaded as a background layer, allowing you to quickly digitize a network model, confirm the network layout, or enhance the output modeling results.

The software can automatically create plan and profile drawings. This greatly speeds up the creation of final deliverables associated with your engineering project. Profile sheets include:

- Maximum HGL and EGL
- Critical depth
- Maximum discharge
- Maximum flow depth
- Maximum flow velocity
- Pipe dimensions (sizes, inverts, etc.)
- Minimum pipe cover
- Sump and rim elevations

All elements are stored on their own individual layers, allowing you to quickly change colors, line styles, text styles, etc. You can change the default settings, such as colors and annotations, to fit your corporate CAD standards.

Easy Model Development

This software is easy to learn and use. Simulation models can be quickly developed using a variety of different sources. Network components can be directly imported from CAD and GIS. The network model can be interactively created using a mouse by pointing and clicking. Graphical symbols are used to represent network elements such as manholes, pipes, pumps, weirs, ditches, channels, catchbasin inlets, and detention ponds. The software allows you, at any time, to interactively add, insert, delete, or move any network element, automatically updating the model. For example, selecting and moving a manhole automatically moves all connected pipes, ditches, channels, and pumps.

Pipes can be curvilinear and lengths automatically computed. Scanned aerial orthophoto TIFF images and maps; GIS and CAD files of streets, parcels, and buildings can be imported and displayed as a background image. This feature allows you to quickly digitize a network model, confirm the network layout, or enhance the output modeling results. Moreover, you can point to or click any network manhole, pipe, pump, weir, ditch, channel, catchbasin inlet, or detention pond from the Plan View to quickly determine the defined input data and output modeling results.

Network Modeling Elements

Autodesk Storm and Sanitary Analysis provides a variety of modeling elements to select from:

- Watershed subbasins
- Inlets and catch basins
- Detention ponds, underground storage structures, and wet wells
- Complex outlet structures
- Flow dividers, standpipes, weirs, orifices, inflatable rubber dams, and valves
- Stormwater and wastewater sewers
- Pumps and lift stations
- Manholes and junctions
- Rivers, streams, and ditches
- Culverts and bridges

Autodesk Storm and Sanitary Analysis is a link-node based model that performs hydrology, hydraulic, and water quality analysis of stormwater and wastewater drainage systems, including sewage treatment plants and water quality control devices. A link represents a hydraulic element (i.e., a pipe, channel, pump, standpipe, culvert, or weir) that transports flow and constituents. There are numerous different link element types supported by the software. A node can represent the junction of two or more links, a storm drain catchbasin inlet, the location of a flow or pollutant input into the system, or a storage element (such as a detention pond, retention pond, settling pond, or lake).

Advanced Output

Autodesk Storm and Sanitary Analysis graphical capabilities can provide detailed plan view plots, profile plots, and time series plots. On the plan view, the software provides automatic color-coding of links and nodes based upon any input or output property, allowing the network to be color-coded based upon pipe sizes, pipe slope, flow rates, velocities, capacity, water quality concentrations, or any other attribute. Directional flow arrows can be plotted on top of pipes to show the flow direction for any time step. Furthermore, pipes can be plotted with variable width and nodes with variable radius, allowing you to quickly identify those areas of the network experiencing the most surcharge, flooding, pollutant concentration, etc.

The software will automatically generate graphical animations for both plan view plots and profile plots which show values that change with respect to time.

Multiple time-series plots can be generated for various network elements, such as pipe flow, velocity, junction water surface elevation, pollutant concentration, or any other output attribute. In addition, the software allows you to display and compare multiple result files simultaneously, allowing direct comparison between different simulation models.

Report Generator

Comprehensive input data and output analysis reports can be automatically generated using the built-in report generator. The software allows full customization of input and output reporting. This allows you unlimited flexibility

and functionality in developing specialized user-defined reports. These reports can be fully customized to meet any combination of modeling criteria.

GIS Support

Autodesk Storm and Sanitary Analysis can share spatial data and visual representation of the stormwater and wastewater sewer network with most GIS spatial databases, allowing the software to be part of the stormwater and wastewater management and planning system. These capabilities can greatly assist in the decision-making processes for network asset inventory, rehabilitation requirements, and financial planning.

The software can intelligently import any GIS database structure, using attribute mapping and geocoding. Also, the analysis solution results can be exported back to the GIS database, allowing locations of CSO and SSO spills, manhole overflows, pipe surcharging, and floodplain flooding to be quickly identified.

Model Checker

Included with Autodesk Storm and Sanitary Analysis is a built-in Model Checker. The Model Checker will review the input data specified for the selected analysis model. If it encounters an error with the input data, it will explain what is wrong and how you can correct it. The Model Checker can be thought of as an expert modeler, pointing out any errors contained within the model.

Hydrology Modeling Capabilities

Autodesk Storm and Sanitary Analysis includes the following hydrology models to determine drainage area runoff:

- USEPA SWMM 5.0 (also imports and exports XPSWMM models)
- NRCS (SCS) TR-55
- NRCS (SCS) TR-20
- US Army Corps HEC-1
- Rational Method
- Modified Rational Method
- DeKalb Rational Method
- Santa Barbara Unit Hydrograph
- Delmarva Unit Hydrograph
- Long-Term Continuous Simulation
- Maricopa & Pima Counties (Arizona) Papadakis-Kazan methodology
- Harris County (Texas) Method

The software accounts for various hydrologic processes that produce runoff from urban areas, including:

- Time-varying rainfall
- Evaporation of standing surface water
- Snow accumulation and melting
- Rainfall interception from depression storage
- Infiltration of rainfall into unsaturated soil layers
- Percolation of infiltrated water into groundwater layers
- Interflow between groundwater and the drainage system
- Nonlinear reservoir routing of overland flow

Spatial variability in all of these processes is achieved by dividing a study area into a collection of smaller, homogeneous subcatchment areas, each containing its own fraction of pervious and impervious sub-areas. Overland flow can be routed between sub-areas, between subcatchments, or between entry points of a drainage system.

Rainfall Designer

Autodesk Storm and Sanitary Analysis includes a Rainfall Designer which allows you to select any location within the USA and it will provide the design rainfall for the specified storm frequency. Alternatively, a user-defined rainfall can be specified. Then the appropriate storm distribution can be selected and the design storm is then created. Multiple design storms can be created and analyzed.

- Automatically determine design rainfall (based upon study location) for 1, 2, 5, 10, 25, 50, and 100 year return frequencies
- Site-specific storm distribution database with over 3,500 up-to-date rainfall recording stations across North America
- Define any storm duration, multiple storm events
- Numerous storm distributions, including SCS, Huff, Eastern Washington, Florida, Chicago Storm, Hurricane Hazel, etc.

Hydraulic Modeling Capabilities

Autodesk Storm and Sanitary Analysis contains a flexible set of hydraulic modeling capabilities used to route runoff and external inflows through the drainage system network of pipes, channels, storage/treatment units, and diversion structures. The software can simultaneously simulate dual drainage networks (stormwater sewer network and city streets as separate but connected conveyance pathways) and inlet capacity. It will quickly determine the amount of stormwater flow that is intercepted by the stormwater network inlets and the amount of stormwater flow that bypasses and is then routed further downstream to other inlets. Hydraulic

network modeling is performed by the Kinematic Wave or Hydrodynamic (i.e., Saint Venant equations) routing methods. The software can account for:

- Storm sewers, sanitary sewers, and combined sewers
- Open channels
- Streams
- Bridges and culverts
- Curb and gutter storm drain inlets
- Detention ponds and outlet structures
- Force mains (using either Hazen-Williams or Darcy-Weisbach equations)
- Flood overflow routing
- And more

Kinematic wave routing provides a non-linear reservoir formulation for channels and pipes, including translation and attenuation effects that assume the water surface is parallel to the invert slope. This method cannot simulate backwater or reverse flow. Hydrodynamic routing solves the complete St. Venant equations throughout the drainage network and includes modeling of backwater effects, flow reversal, surcharging, looped connections, pressure flow, tidal outfalls, and interconnected ponds. Flow can also be routed through a variety of different storage elements, such as detention ponds, settling ponds, and lakes.

The software can model simple to complex networks, including the ability to:

- Handle networks of unlimited size
- Simultaneously account for dual drainage pathways and networks

The software can model various flow regimes, such as:

- Subcritical, critical, and supercritical flow regimes
- Gravity and pressurized (surcharged) flow
- Flow reversals
- Flow splits and combines
- Branched, dendritic, and looped systems
- Tailwater submergence (backwater) effects
- Interconnected ponds
- Surface ponding
- Tidal outfalls

In addition to standard network elements, the software can model special elements such as:

- Storage and treatment units
- Flow dividers
- Curb openings, gutter inlets, and median inlets
- Pumps (including user-defined controlled pumps)
- Weirs (including compound weirs and spillways)
- Orifices and standpipes
- Inflatable rubber dams (including user-defined controlled rubber dams)
- Valves (including user-defined controlled valves)

Finally, the software is capable of:

- Using a wide variety of standard pipe shapes, custom pipe shapes, open channel shapes, as well as natural channel geometry
- Applying external flows and water quality inputs from surface runoff, groundwater interflow, rainfall-dependent infiltration/inflow (RDII), dry weather sanitary flow, and user-defined inflows
- Applying user-defined dynamic control rules to simulate the operation of pumps, orifice openings, and weir crest levels
- And more

Interconnected Detention Pond Modeling

Autodesk Storm and Sanitary Analysis enables accurate routing in complex detention pond situations. In some situations, downstream conditions can cause backwater effects that influence the performance of a detention pond outlet structure. For example, an upstream pond may discharge to another downstream pond that is similar in elevation or influenced by downstream flooding. Such situations can result in a decrease in outlet discharges or flow reversal back into the upstream pond and can be difficult to model properly. Most approaches attempt to simplify the problem using overly conservative assumptions about the downstream water surface conditions that result in oversized detention facilities and increased costs. Still other methods ignore the downstream effects, thereby resulting in overtopping of the resulting undersized ponds. However, the software's interconnected pond routing allows you to easily model these complex situations with confidence.

The software can handle simple to complex detention pond designs:

- Handles single pond, multiple ponds, and interconnected ponds
- Provides constant feedback on how the detention pond design is progressing
- Uses industry-standard FHWA Hydraulic Design Series in performing its outlet calculations
- Handles variable tailwater conditions, including tailwater submergence effects
- Models ponds with multiple outlets and flow diversions

For detention pond structures, both simple and complex outlet structures can be considered, including:

- Inlet boxes
- Multiple orifices
- Multi-port risers
- Compound spillways
- Culverts
- User-defined outflow structures

Underground Stormwater Detention and Infiltration

On-site, underground stormwater retention/detention can be incorporated into your network model. Subsurface vaults or systems of large diameter interconnected storage pipes, arched pipes, or manufactured storage chambers can be modeled. The software includes standard storage chambers from leading manufacturers. Simply select the storage chamber model from a selection list, define the quantity, backfill dimensions, stone void space, and go!

Infiltration Basins

The software can model infiltration basins, accounting for both pollutant removal and reduction of stormwater released from the basin. In addition, wet and dry retention ponds can be modeled.

Highway Drainage Design

Autodesk Storm and Sanitary Analysis automates your highway drainage design work. The software can simulate dual drainage systems (stormwater sewer network and city streets as dual conveyance pathways) and inlet capacity. It will quickly determine the amount of stormwater flow that is intercepted by the stormwater network inlets and the amount of stormwater flow that bypasses and is then routed further downstream to other inlets.

Highway drainage capabilities include:

- Compare pre- and post-development hydrology
- US Federal Highway Administration (FHWA) HEC-22 computations included
- Select from standard curb openings, grated inlets, slotted inlets, median ditch inlets, and combination inlets
- Account for on-sag and on-grade conditions
- Lookup standard curb openings and grated inlets from major manufacturers and agencies
- Compute gutter spread, depth of flow, inlet efficiency, inlet spacing, velocity of flow for gutter and pavement sections
- Submit agency-ready drainage reports

Water Quality Modeling Capabilities

Autodesk Storm and Sanitary Analysis provides you with all the tools necessary to perform your urban stormwater water quality modeling:

- Account for rain gardens, green roofs, rain barrels, bioswales, dry detention ponds, wet ponds, retention ponds, wetlands, and more
- Model particulate settling, water cleanup, water quality best management practices (BMP), and TMDL (Total Maximum Daily Loads)

NPDES

As part of the NPDES (National Pollutant Discharge Elimination System) permitting process, modeling of stormwater quality and quantity may be required. The software can model all aspects of stormwater quality and quantity, and can incorporate best management practices (BMP) directly within the model.

The following processes can be modeled for any number of user-defined water quality constituents:

- Dry-weather pollutant buildup over different land uses
- Pollutant washoff from specific land uses during storm events
- Direct contribution of rainfall deposition
- Reduction in dry-weather buildup due to street cleaning
- Reduction in washoff load due to BMPs
- Entry of dry weather sanitary flows and user-specified external inflows at any point in the drainage system
- Routing of water quality constituents through the drainage system
- Reduction in constituent concentration through treatment in storage units or by natural processes in pipes and channels

Sanitary Sewer Modeling Capabilities

Quickly perform advanced municipal sanitary and wastewater sewer network modeling with Autodesk Storm and Sanitary Analysis. The software is a fully

hydrodynamic model that can analyze both simple and complex sanitary and combined sewer systems.

- Use for master planning, rehabilitation, new design, and include future growth in your sewer model
- Model looped networks, flow splits, combines, overflows, and storage capacity
- Analyze sanitary or combined sewer systems
- Include manholes, inlets, sewer networks, pumps, lift stations, storage structures, control structures, force mains, inverted siphons, overflow diversions, relief sewers, and other elements within a single model
- Construct network sewer models from CAD drawings or GIS geodatabases
- Check CMOM (Capacity, Management, Operation, and Maintenance) capacity requirements for compliance
- Find and fix sewer bottlenecks, optimize control rules, reduce overflow occurrences, perform capacity analyses, etc.
- Regulate flow to treatment facilities by determining storage within the sewer system and design storage structures
- Perform CSO (combined sewer overflows) and SSO (sanitary sewer overflows) mitigation studies while accounting for RDII (rainfall derived inflows and infiltration)

Getting Started

2

This section provides you with some basic information to help you get started using Autodesk Storm and Sanitary Analysis software.

User Interface Basics

This section provides an overview of the major elements of the user interface. The Autodesk Storm and Sanitary Analysis user interface is shown in the below figure.

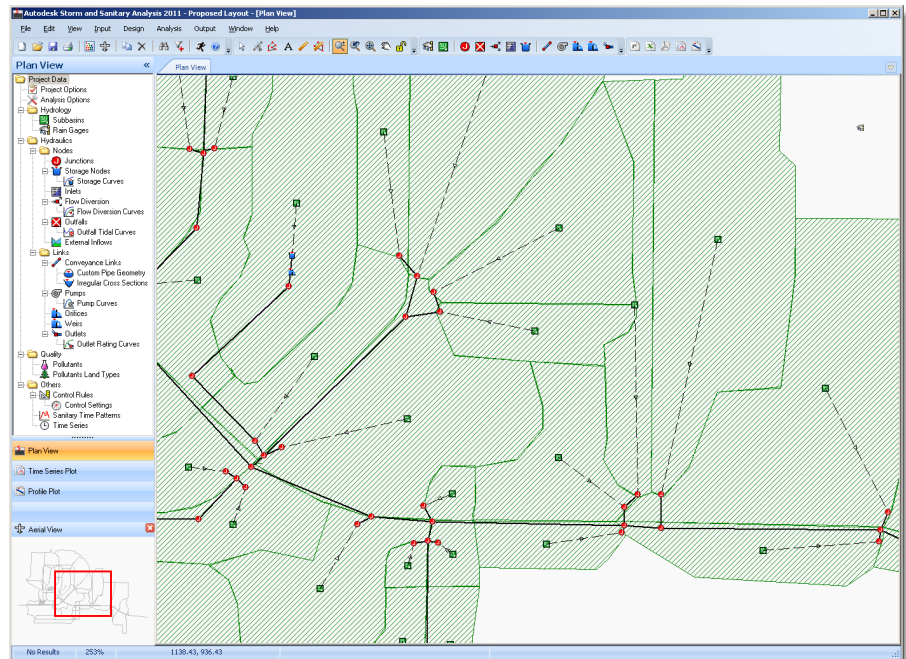

Figure 2.1 The Autodesk Storm and Sanitary Analysis user interface

The user interface consists of the following components:

- Plan View
- Menu Bar
- Data Tree
- Toolbars
- Status Bar
- View Tabs

Plan View

The Plan View, as shown in the following figure, provides a layout view (or top view) of the stormwater or wastewater network system. The individual elements

that make up the network are displayed. The Plan View also allows you to graphically layout the drainage network system.

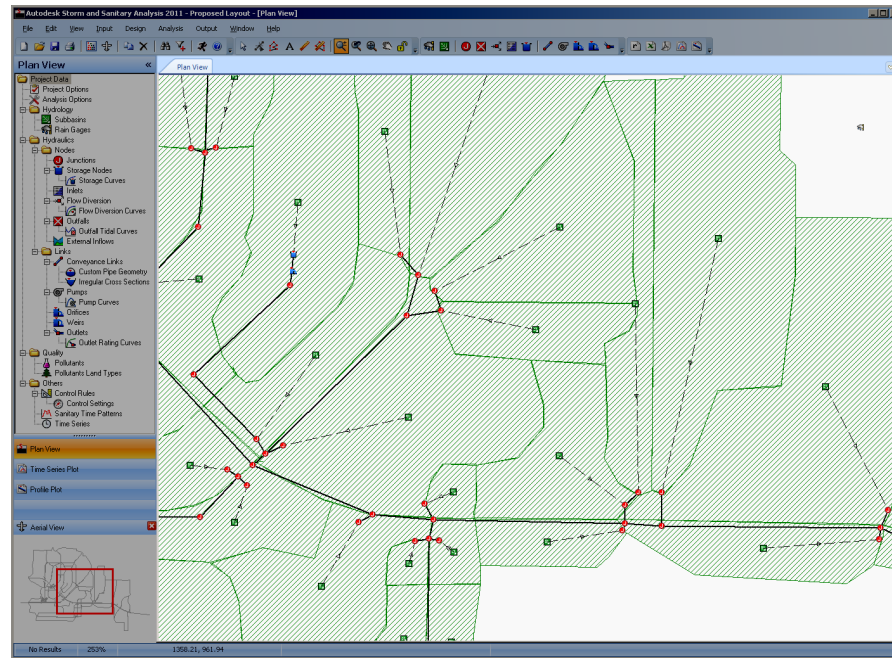

Figure 2.2 The Plan View (see highlighted section)

Key items of the Plan View include:

- The location of drainage network elements and the distances between them do not have to conform to the actual physical scale; they can represent a schematic diagram of the network.
- Elements can have their properties, such as flooding depth at junction nodes or flow velocity in channels and pipes, displayed using different colors. This color coding can be controlled using the displayed legend.
- New network elements can be added directly to the Plan View and existing elements can be selected for editing, deleting, and repositioning.
- Background images, such as geo-referenced TIFF aerial orthophoto images and maps, can be displayed as a background for reference.
- CAD drawing files, such as a street drawing, can be imported and displayed as a background for reference.
- The displayed drainage network can be zoomed into and panned from one position to another.
- Junction nodes, channels, and pipes can be displayed at different sizes to indicate a particular property.
- Flow directional arrows can be displayed on channels and pipes to indicate the direction of flow from the analysis results.
- Element ID labels and numerical property values can be displayed adjacent to network elements.
- The Plan View can be printed, copied to the Microsoft Windows clipboard for pasting into a Word document, or exported as an AutoCAD drawing file for report generation.

Menu Bar

The menu bar, as shown in the following figure, provides access to all of the software's capabilities.

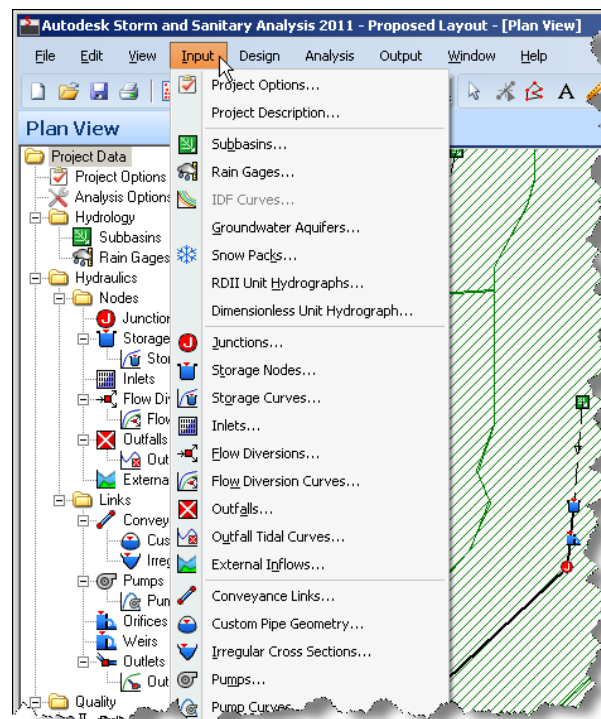



Figure 2.3 The Input Menu available from the menu bar

The menus are grouped by command type. These menus include:

File	Commands for opening and saving data files; importing geo-referenced orthophotos; importing and exporting AutoCAD drawings, AutoCAD Hydraflow files, LandXML files, GIS shapefiles, EPA SWMM input files, and XPSWMM input files; and for printing.
Edit	Commands for editing and copying.
View	Commands for viewing, configuring the Plan View display options, and displaying the toolbars.
Input	Access to all of the drainage network element dialog boxes that define the model input data.
Design	Commands for performing design functions on the network model.
Analysis	Commands for defining analysis parameters and for performing the network model analysis.
Output	Commands for displaying the network model analysis results as graphical plots and reports.
Time Series Plot	Commands for the analysis results time series plot, if this plot is being displayed. Otherwise, this menu is not available.
Window	Commands for arranging and selecting windows within the application workspace.
Help	Commands for getting help.

Data Tree

The Data Tree, as shown in the following figure, provides access to all of the data elements contained in a project. Select the **EXPAND**  and **COLLAPSE**  icons to see the hierarchical representation of the data associated with a modeling project. The contents of the data tree vary, depending on what data is defined.

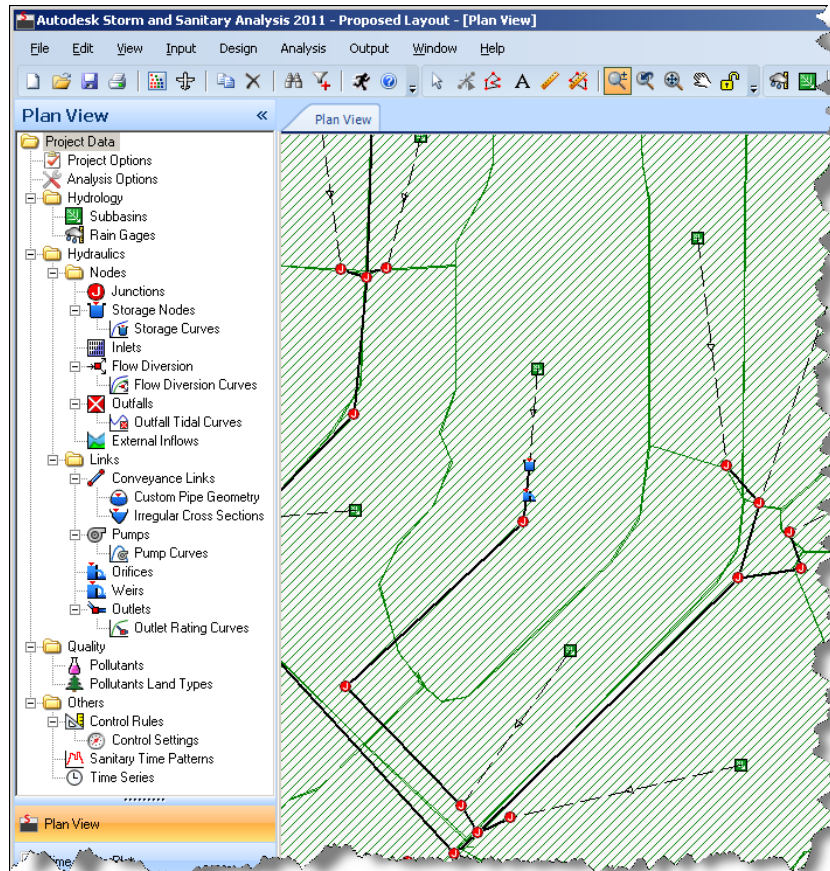

Figure 2.4 The Data Tree

The Data Tree displays the various categories of data elements for the network project. Double-clicking an element causes the corresponding network element dialog box to be displayed.

Toolbars

The software provides numerous toolbars that give you quick access to many commands and features. If you forget what a particular toolbar button accomplishes, point the cursor at the toolbar button. After you pause over the button, a tooltip will be displayed providing a description of what the button performs.

The toolbars provided include:

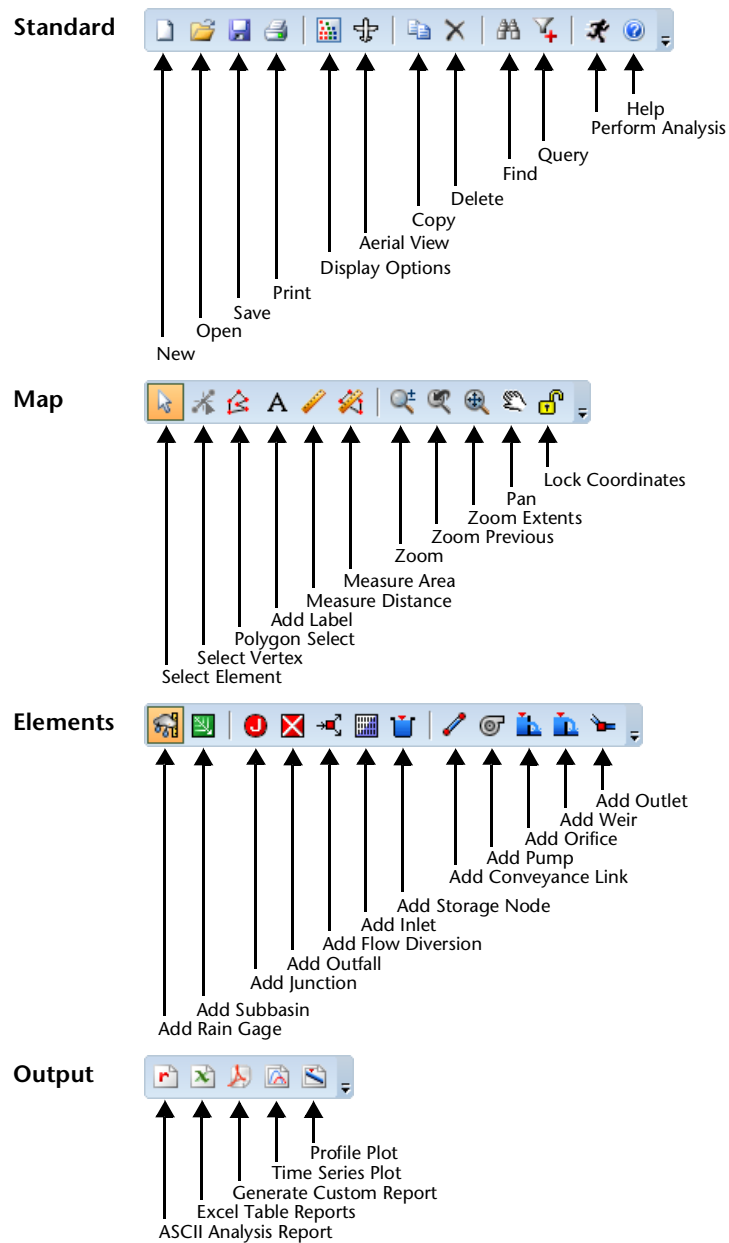

All toolbars are docked underneath the menu bar. To display a toolbar, select the **VIEW** menu and the appropriate toolbar. As shown in the following figure, a check mark will appear displayed adjacent to the toolbar to indicate that it is visible.

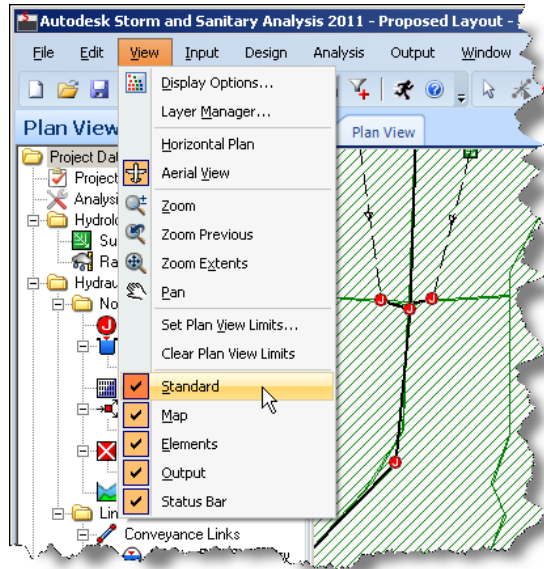

Figure 2.5 Displaying a toolbar

Status Bar

The Status Bar, as shown in the following figure, appears at the bottom of the application, and provides information about the network model or the task you are working on.



Figure 2.6 The Status Bar provides information about the network model being worked on

The Status Bar is divided into five sections, as described below.

Run Status

This section of the status bar indicates whether the simulation results are available. Three different states can be shown:

- No Results** Analysis results are not available. Re-run the simulation to get the results.
- Results Complete** Analysis results available.
- Results Differ** Analysis results are available, but may be invalid because the model data has been modified. Re-run the simulation to get the results.

Zoom Level

This section of the status bar indicates what the current zoom level is for the Plan View. A value of 100% indicates that the Plan View is zoomed to the extent of the model.

XY Coordinates

This section of the status bar indicates the current coordinates of the mouse pointer.

Element Information

As shown in the following figure, this section of the status bar details information regarding the element directly underneath the mouse pointer.

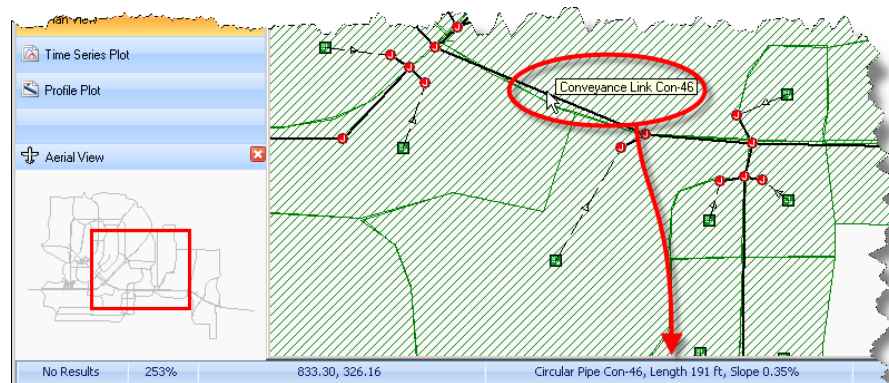



Figure 2.7 The status line details information regarding the element directly underneath the mouse pointer

View Tabs

The view tabs at the top of the screen allow you to quickly move from one view to another by clicking the tab of your choice. As shown in the following figure, the view tab of the active view has a foreground color, tabs for inactive views have a background color. To close a tab, click the  symbol on the tab.

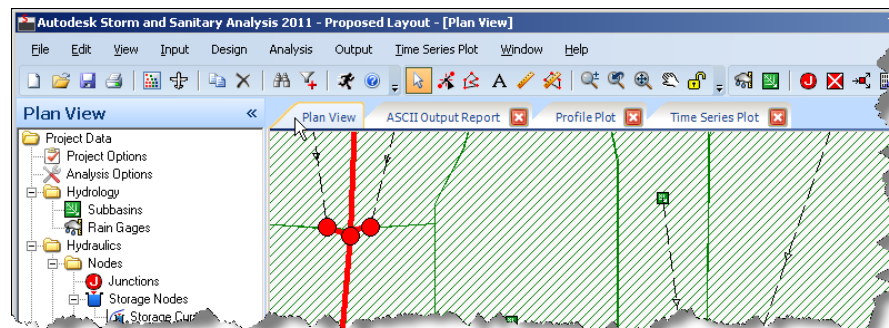



Figure 2.8 The view tabs at the top of the screen allow you to quickly move from one view to another

Input Data Dialog Boxes

Note that the software uses interactive dialog boxes for editing network input data. Simply double-click an element from the Plan View using the **SELECT ELEMENT**  tool as shown in the following figure. The appropriate element dialog box is then displayed.

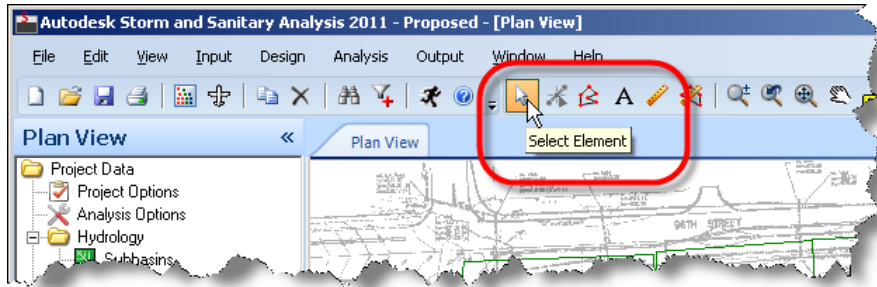

Figure 2.9 Click the Select Element tool and then double-click a network element to display the corresponding element dialog box

The network element dialog boxes are modeless—allowing you to keep them displayed while selecting other elements in the network from the Plan View. For example, to examine manhole rim elevations, you can keep the Junctions dialog box displayed and simply select different junctions from the Plan View. Upon selecting a new junction, the software automatically updates the input (and output) data regarding the selected element, as shown in the following figure.

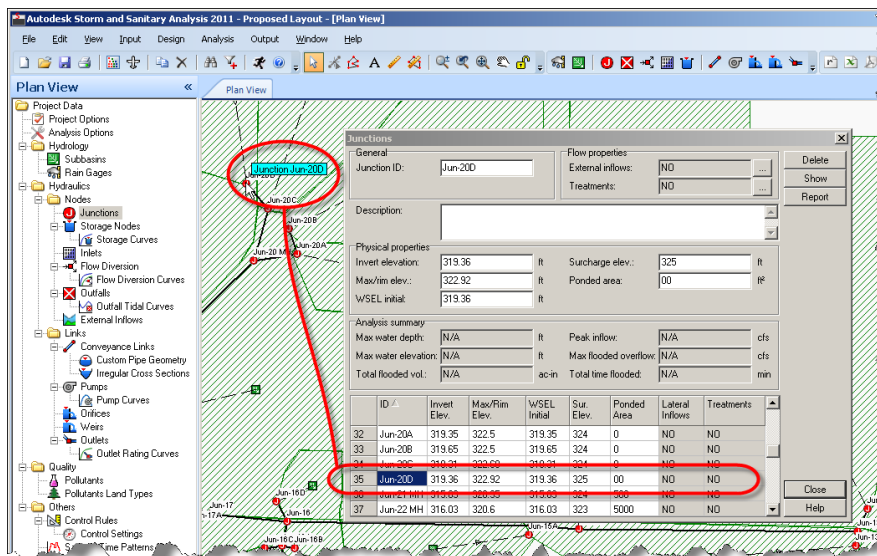

Figure 2.10 Network element dialog boxes are modeless, allowing you to interactively select different elements while the network element dialog box is displayed

In most network element dialog boxes, the network element data is displayed in a table, allowing you to easily browse, edit, copy, and paste data. In addition, clicking the column header at the top of the table allows you to sort the data in descending (or if clicked twice, ascending) order, as shown in the following figure. For example, using this feature allows you to quickly find “outliers” in the defined element data where there may have been a data input blunder. Sorting the column allows you to see if there are any elements with unusual values or perhaps a missing value.

Max water elevation: 879.00		ft		Max flooded overflow: 0		ft	
Total flooded vol.: 0		ac-in		Total time flooded: 0		min	
ID	Invert Elev.	Max/Rim Elev.	WSEL Initial	Sur. Elev.	Ponded Area	Lateral Inflow	
4	Jun-42	879	894	879	894	25	NO
5	DCS 25	876.26	882	876.26	882	25	NO
6	AGRI 17	876.1	873	876.1	877.5	25	NO
7	DCS 13	873	873	873	878	25	NO
8	DCS 15	871.4	877	871.4	877	25	NO
9	DCS 16	870.5	882	870.5	882	25	NO

Figure 2.11 Clicking a column heading within the table allows you to sort the element data based upon the column selected

Multiple network element dialog boxes can be displayed, if desired. However, the computer monitor may become somewhat cluttered with dialog boxes. If you have dual monitors at your computer, you can grab the element dialog boxes and drag them to the other monitor allowing you to more effectively edit the network. Once completed with the data input for a particular network element, click the Close button.

Program Options

The program configurations are defined by the Options dialog box, as shown in the following figure. Select **EDIT ► OPTIONS** to display the Options dialog box.

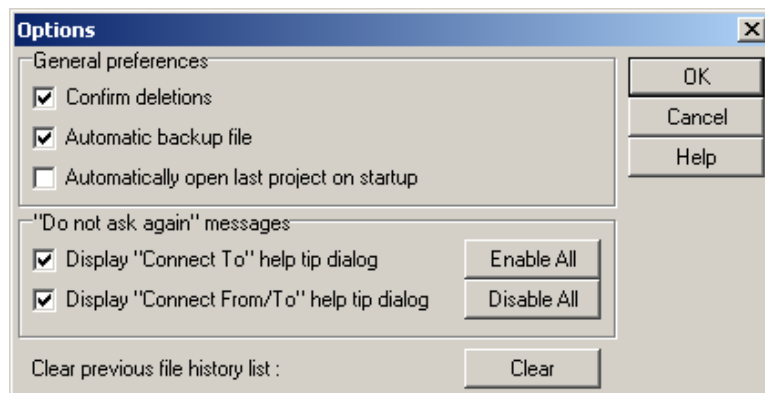

Figure 2.12 The Options dialog box controls the program configuration options

The following configuration settings can be specified in the Options dialog box.

Confirm Deletions

This check box causes a confirmation dialog box to be displayed before deleting any network element.

Automatic Backup File

This check box causes the software to automatically save a backup copy of a newly opened project. The default backup file extension is **.BCK** so as not to overwrite a Civil 3D or Map 3D drawing file backup.

Automatic Open Last Project on Startup

This check box causes the software to automatically load the last saved project upon program startup.

“Do not ask again” Messages

These check boxes control whether the Help Tip dialog boxes will be displayed.

Clear Previous File History List

Clicking Clear causes the list of most recently opened projects to be cleared from the File Menu.

Plan View Features

The tools provided for the Plan View window allow you to quickly interact with the software to develop a drainage network. The following sections describe these tools in detail.

Standard Toolbar

The Standard toolbar, as shown in the following figure, provides you quick access to commonly used commands, such as printing and saving.

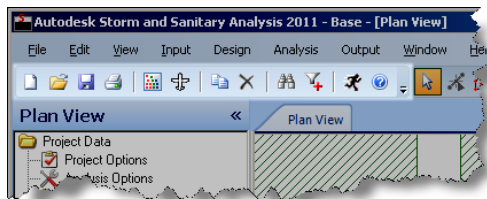













Figure 2.13 The Standard toolbar provides quick access to commonly used commands, such as printing and saving

The following commands are provided from the Standard toolbar:

-  Create New Project
-  Open Existing Project
-  Save Current Project
-  Print Currently Active Window
-  Display Options
-  Aerial View
-  Copies Selection to Clipboard
-  Delete
-  Find a Specific Element
-  Query Elements
-  Perform Analysis
-  Help

Map Toolbar

The Map toolbar, as shown in the following figure, provides quick access to commonly used commands for editing and viewing the network elements in the Plan View.

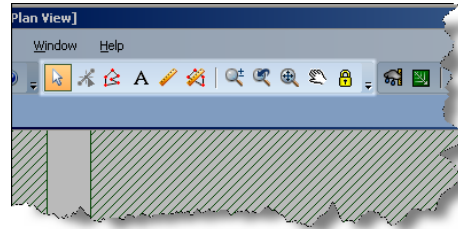

Figure 2.14 The Map toolbar provides quick access to commonly used commands for editing and viewing the network elements

The following tools are provided from the Map toolbar for editing and viewing network elements.

Select Element Tool

The **SELECT ELEMENT** tool is used to select network elements in the Plan View. The following can be done with the **SELECT ELEMENT** tool:

- Double-clicking a network element will display the appropriate element dialog box with the selected element current, allowing you to edit its properties. For example, double-clicking a junction will display the Junctions dialog box with the selected junction current.
- Network elements (e.g., subbasins, junctions, rain gages, etc.) can be dragged to new locations. Select the element and then drag the element to the desired location. To lock the elements in place so that they cannot be accidentally moved, select **EDIT ► LOCK COORDINATES** and a check mark will show up to signify that the elements (and corresponding vertices) are locked in place.
- Network elements can be deleted. Select the element and then press Delete. Note that the software will confirm the delete command before it is performed. Note that you can disable the delete confirmation check in the Options dialog box (select **EDIT ► OPTIONS**, see page 19).
- Network elements can be converted to a different type of element. Select the element and then right-click. From the displayed context menu, select **CONVERT TO**. Then, select the element type to convert to. Only data that is common to both element types will be preserved after the element is converted.

Edit Vertices Tool

The **EDIT VERTICES** tool is used to grip edit subbasin, channel, and pipe vertex points in the Plan View. To grip edit a network element vertex, the following can be done:

- 1 Select the subbasin, channel, or pipe to edit using the **SELECT ELEMENT** tool.
- 2 Change to *Vertex Editing* mode by clicking the **EDIT VERTICES** tool, selecting **EDIT ► EDIT VERTICES**, or right-clicking the element and choosing **EDIT VERTICES** from the displayed context menu.

- 3 The mouse pointer will change into an arrow tip, and any existing vertices on the selected network element will be displayed as small squares. The currently selected vertex will be displayed as a filled square. To select a particular vertex, click it.
- 4 To add a new vertex, right-click and select **ADD VERTEX** from the displayed context menu or press Insert on the keyboard.
- 5 To delete the currently selected vertex, right-click and select **DELETE VERTEX** from the displayed context menu or press Delete from the keyboard.
- 6 To move a vertex to another location, select the vertex and drag it to its new location.
- 7 While in *Vertex Editing* mode, you can begin editing the vertices for other network elements by clicking an element. To leave *Vertex Editing* mode, right-click and select **QUIT EDITING** from the displayed context menu or select another tool from the toolbar.

Select Polygon Tool

The **SELECT POLYGON** tool is used to select a group of elements in the Plan View for editing or deleting. The following can be done with the **SELECT POLYGON** tool:

- 1 To select a group of network elements, click the **SELECT POLYGON**  tool or choose **EDIT ► SELECT POLYGON**.
- 2 Draw a polygon around the area of interest on the Plan View by clicking for each point of the polygon.
- 3 Close the polygon selection by either double-clicking or pressing Enter.

Measure Distance Tool

The **MEASURE DISTANCE** tool is used to measure a distance, such as overland flow length or subbasin equivalent width from the Plan View. Measuring a distance can be done in the following manner:

- 1 Click the **MEASURE DISTANCE**  tool or choose **DESIGN ► MEASURE DISTANCE**.
- 2 On the Plan View, click the mouse to draw a line to be measured. Click to define each vertex of the line.
- 3 While creating the line, it is not unusual to make a mistake digitizing by clicking at the wrong location.

Press the Backspace key to delete the last segment. Alternatively, right-click and select **DELETE LAST SEGMENT** from the displayed context menu.

Press the Esc key to cancel the command. Alternatively, right-click and select **CANCEL** from the displayed context menu.

- 4 Double-click or press Enter to complete the line being measured. Alternatively, right-click and select **DONE** from the displayed context menu. The software then displays the length of the line.

Note that pressing Esc while measuring cancels the command.

Measure Area Tool

The **MEASURE AREA** tool is used to measure an area, such as soil type area or land use area from the Plan View. Measuring an area can be done in the following sequence:

- 1 Click the **MEASURE AREA**  tool or choose **DESIGN ► MEASURE AREA**.
- 2 On the Plan View, click the mouse to draw a polygon outline of the area being measured. Click to define each vertex of the polygon.
- 3 While creating a polygon boundary, it is not unusual to make a mistake digitizing by clicking at the wrong location.

Press the Backspace key to delete the last segment. Alternatively, right-click and select **DELETE LAST SEGMENT** from the displayed context menu.

Press the Esc key to cancel the command. Alternatively, right-click and select **CANCEL** from the displayed context menu.

- 4 Double-click or press Enter to complete the polygon being measured. Alternatively, right-click and select **DONE** from the displayed context menu. The software will automatically close the polygon and display the area of the polygon.

Note that pressing Esc while defining the polygon cancels the command.

Zoom Tool

The **ZOOM** tool is used to zoom in and out of the viewing area of the Plan View, Profile Plot, and Time Series Plot. Zooming can be done with the following sequence:

- With the **ZOOM** tool, clicking the view zooms the viewing area in around the point by a factor of two. Holding down the Shift key while clicking causes the view to zoom out.
- With the **ZOOM** tool, a rectangle can be dragged around a portion of the viewing area to zoom in to that region.
- If your mouse has a scroll wheel, you can scroll the wheel to zoom in and out. This is especially handy when you have another tool active and you do not want to switch tools.

Zoom Previous Tool

The **ZOOM PREVIOUS** tool is used to display the previous view.

Zoom Extents Tool

The **ZOOM EXTENTS** tool is used to zoom out to the full extents of the Plan View, Profile Plot, and Time Series Plot.

Pan Tool

The **PAN** tool is used to pan the viewing area of the Plan View, Profile Plot, and Time Series Plot. Panning can be performed in the following manner:

- With the **PAN** tool, holding down the left mouse button while dragging moves the viewing area.
- If your mouse has a scroll wheel (or a middle button), hold it down and drag to pan the viewing area. This is especially handy when you have another tool active and you do not want to switch tools.

Lock Coordinates

The **LOCK COORDINATES** icon is used to lock and unlock the network elements from being moved within the Plan View, preventing the accidental movement of elements.

Elements Toolbar

The Elements toolbar, as shown in the following figure, allows you to interactively construct a drainage network model by placing and drawing network elements in the Plan View.

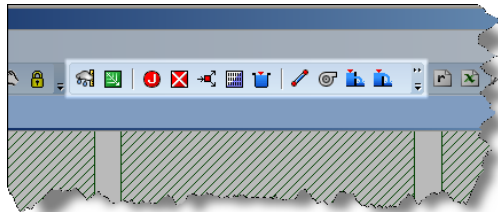

Figure 2.15 Elements toolbar allows you to interactively construct a drainage network by graphically drawing the network

The following tools are provided from the Elements toolbar for creating the network elements.

 Add Rain Gage







 Add Subbasin

 Add Junction

 Add Outfall

 Add Flow Diversion

 Add Inlet

-  Add Storage Node
-  Add Conveyance Link
-  Add Pump
-  Add Orifice
-  Add Weir
-  Add Outlet

A complete description on how to construct the drainage network graphically using the above element tools is described in the section titled *Defining a Network Model* on page 40.

Output Toolbar

The Output toolbar, as shown in the following figure, provides quick access to commonly used commands for viewing the analysis output results.

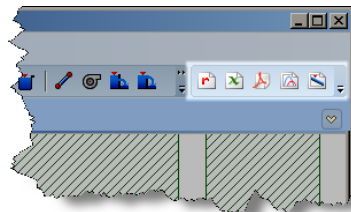



Figure 2.16 Output toolbar provides quick access to commands for viewing the analysis output results

The following commands are provided from the Output toolbar for viewing the analysis output results.

-  ASCII Output Report
-  Excel Table Reports
-  Generate Custom Report
-  Time Series Plot
-  Profile Plot

A complete description on how to view the analysis output results using the above output tools is described in the chapter titled *Display Analysis Results* on page 107.

Display Options

The Plan View display can be modified using the Display Options dialog box, as shown in the following figure.

To show the Display Options dialog box:

- Select **VIEW ► DISPLAY OPTIONS**
- Click the **DISPLAY OPTIONS**  icon
- Right-click the Plan View to display the context menu and then select **DISPLAY OPTIONS**

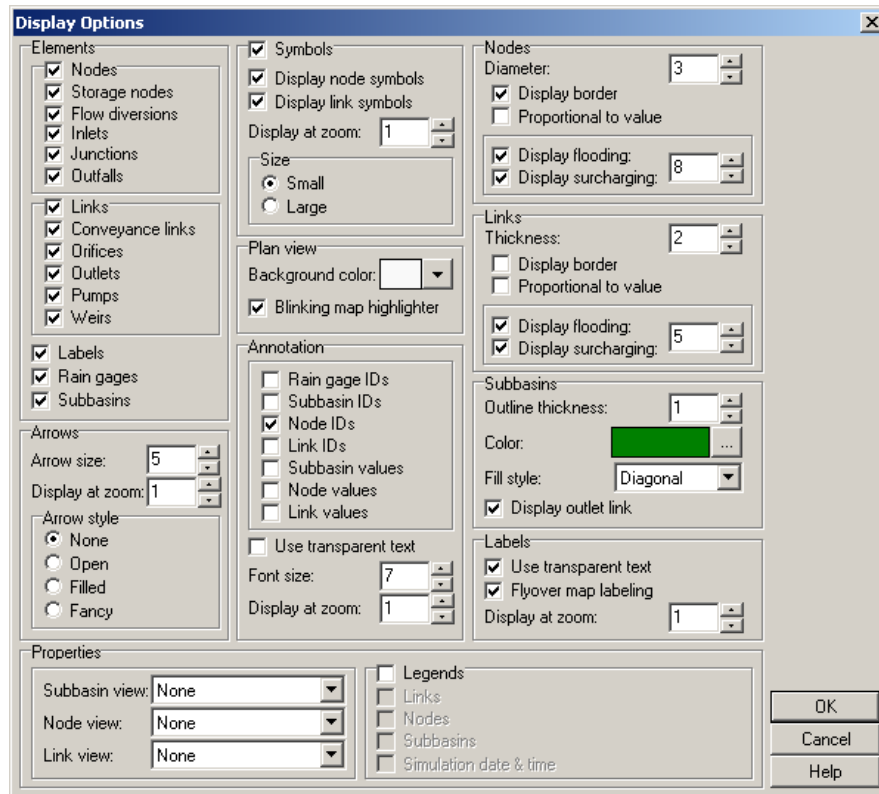

Figure 2.17 The Display Options dialog box controls the display options for the Plan View

The Display Options dialog box is broken down into sections, representing various display option categories.

Elements

The Elements section controls the display of network elements. Select the check box adjacent to each element type to control the display of that element type.

Subbasins

The Subbasins section controls how subbasin areas are displayed on the Plan View.

Outline Thickness

This spin control defines the thickness of the line used to draw the subbasin boundary. Specify a thickness of zero if no boundary is to be displayed.

Color

This color panel allows you to select the color to display the subbasin as. Click the  browse button to display a color selection dialog box, which is used to change the color for the subbasins.

Fill Style

This radio button group specifies the style used to fill the interior of the subbasin area.

Display Outlet Link

This check box denotes whether a dashed line is to be drawn between the subbasin centroid and the subbasin's outlet node (or outlet subbasin).

Nodes

The Nodes section controls how nodes are displayed on the Plan View.

Diameter

When mapping input data or output results on to the nodes (e.g., invert elevation, water depth, total inflow, etc.), this spin control defines the default node diameter (or width) in pixels. When not mapping input data or output results on to the nodes, the nodes are displayed as their element icon.

Display Border

When mapping input data or output results on to the nodes, this check box defines if a border should be drawn around each node. This is recommended for light-colored backgrounds.

Proportional to Value

When mapping input data or output results on to the nodes, this check box specifies if the node diameter should increase as the viewed parameter increases in value.

Display Flooding

After the analysis is complete, this check box defines if a flooded node should be displayed on the Plan View in the color of blue. The adjacent spin control regulates the size of the displayed flooded and surcharged nodes.

Display Surcharging

After the analysis is complete, this check box defines if a surcharged node (bolted manhole cover) should be displayed on the Plan View in the color of red. The adjacent spin control regulates the size of the displayed flooded and surcharged nodes.

Links

The Links section controls how links are displayed on the Plan View.

Thickness

When mapping input data or output results on to the links (i.e., diameter, flow rate, etc.), this spin control defines the link thickness in pixels.

Display Border

When mapping input data or output results on to the links, this check box defines if a black border should be drawn around each link. This is recommended for light-colored backgrounds.

Proportional to Value

When mapping input data or output results on to the links, this check box specifies if the link thickness should increase as the viewed parameter increases in value.

Display Flooding

After the analysis is complete, this check box defines if a flooding link should be displayed on the Plan View in the color of blue. The adjacent spin control regulates the width of the displayed flooded and surcharged links.

Display Surcharging

After the analysis is complete, this check box defines if a surcharged pipe should be displayed on the Plan View in the color of red. The adjacent spin control regulates the width of the displayed flooded and surcharged links.

Symbols

The Symbols section determines which element types are represented with special symbols on the Plan View.

Display Node Symbols

If checked, then special node symbols will be used. Otherwise, simple circles will be used.

Display Link Symbols

If checked, then special link symbols will be used.

Display At Zoom

This spin control defines the minimum zoom ratio at which symbols should be displayed. Symbols will be hidden at zoom ratios smaller than this.

Size

This radio group allows you to specify the symbol size to use.

Labels

The Labels section controls how labels are displayed on the Plan View.

Use Transparent Text

This check box will display the labels with a transparent background. Otherwise, an opaque background will be used.

Flyover Map Labeling

This check box will cause the element ID label and the value of the selected property to be displayed adjacent to the element whenever the mouse is placed over an element on the Plan View.

Display at Zoom

This spin control defines the minimum zoom ratio at which labels should be displayed. Labels will be hidden at zoom ratios smaller than this.

Arrows

The Arrows section controls how element directional and flow arrows are displayed on the Plan View. Note that flow arrows will only be displayed after an analysis has been performed, and a computed output parameter has been selected for display.

Otherwise, element directional arrows will point from the starting node to the ending node.

Arrow Size

This spin control sets the element directional and flow arrow size.

Display At Zoom

This spin control defines the minimum zoom ratio at which element directional and flow arrows should be displayed. Element directional and flow arrows will be hidden at zoom ratios smaller than this.

Arrow Style

This radio group defines the shape of element directional and flow arrow to display. Select **NONE** to hide the arrows.

Plan View

These options affect the general display options of the Plan View.

Background Color

The drop-down entry allows you to select the background color for the Plan View.

Blinking Map Highlighter

This check box controls whether the selected element on the Plan View is to blink.

Annotation

The Annotation section controls what element IDs and specified values are to be displayed on the Plan View.

Use Transparent Text

This check box will display the labels with a transparent background. Otherwise, an opaque background will be used.

Font Size

This spin control sets the annotation font size.

Display at Zoom

This spin control defines the minimum zoom ratio at which annotation should be displayed. Annotation will be hidden at zoom ratios smaller than this.

Properties

The Properties section defines how subbasins, nodes, and links are color-coded based upon the selected input or output property. From the element drop-down list, select the property to be displayed as a color-coded attribute. The Plan View then displays the elements similar to the following figure.

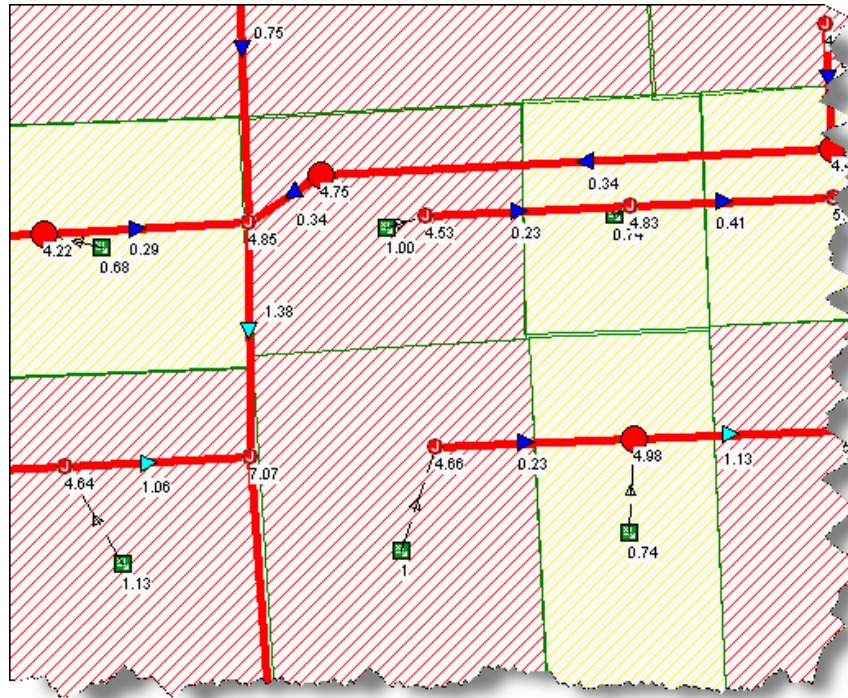

Figure 2.18 The Properties section of the Display Options dialog box allows you to color-code subbasins, nodes, and links based upon an input or output property

The following element properties are available for selection. Note that element output properties (i.e., Total Inflow, etc.) are only available after the analysis has been performed. Select **NONE** if you do not want to have any elements to be colored based upon a property.

Subbasins

Basin Area	Drainage area (acres or hectares)
Basin Slope	(ft/ft or m/m)
Equivalent Width	(ft or m)
Groundwater Elevation	(ft or m)
Groundwater Flow	Groundwater flow into drainage network (cfs or cms)
Loss Rate	Infiltration + evaporation (in/hr or mm/hr)
Rainfall Rate	(in/hr or mm/hr)
Runoff Flow Rate	(cfs or cms)
Snow Depth	(in or mm)
Water Quality	Washoff concentration or each pollutant (mass/liter)

Nodes

Flooding Flow Rate	Surface flooding (inflows lost from the system when the water depth exceeds the defined maximum node depth, cfs or cms)
Invert Elevation	(ft or m)
Lateral Inflow	Runoff + all other external inflows (cfs or cms)
Total Inflow	Lateral inflow + upstream inflows (cfs or cms)
Volume	Water volume held in storage (including ponded water, ft ³ or m ³)
Water Depth	Water depth above node invert (ft or m)
Water Surface Elevation	(ft or m)
Water Quality	Concentration of each pollutant after treatment (mass/liter)

Links

Average Depth	Average water depth (ft or m)
Capacity Ratio	Ratio of Depth to Full Depth
Flow Rate	(cfs or cms)
Flow Velocity	(ft/sec or m/sec)
Froude Number	
Maximum Depth	Maximum water depth (ft or m)
Roughness	
Slope	(ft/ft or m/m)
Water Quality	Concentration of each pollutant (mass/liter)

Legends

The Legends section defines which element property legend should be displayed on the Plan View, as shown in the following figure. The legends display colors that are associated with a range of values for the element property being viewed. Separate legends exist for subbasins, nodes, and links. If a particular element property is set to **NONE**, then that element's legend will not be displayed. Also, an option is available for displaying the date and clock time of the simulation period being viewed on the map.

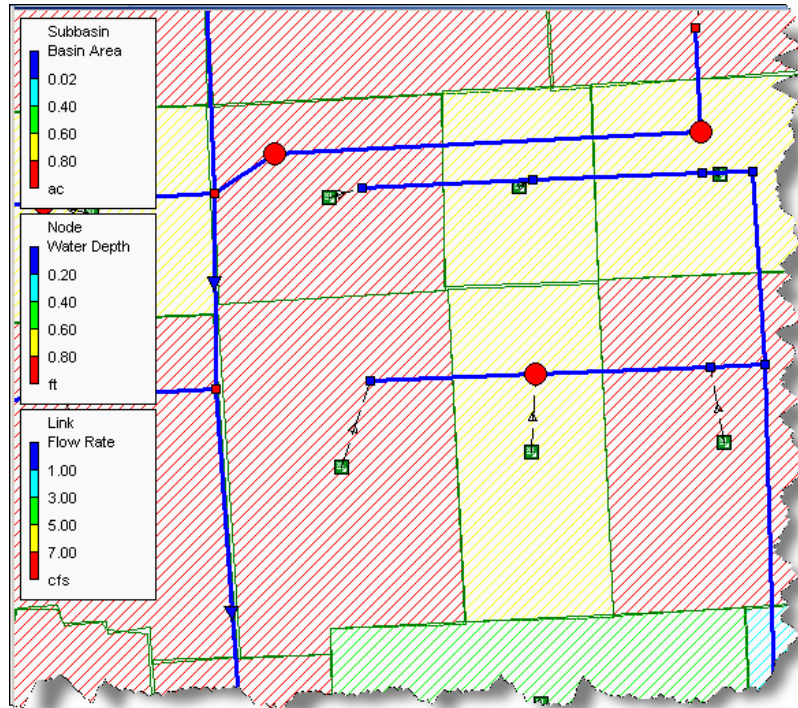

Figure 2.19 The displayed legends show colors that are associated with a range of values for the element property being viewed

To turn off a legend that is displayed in the Plan View, double-click it. To re-display a legend that was turned off, right-click the Plan View. The software will display a context menu, which allows you to turn on the display of the legend.

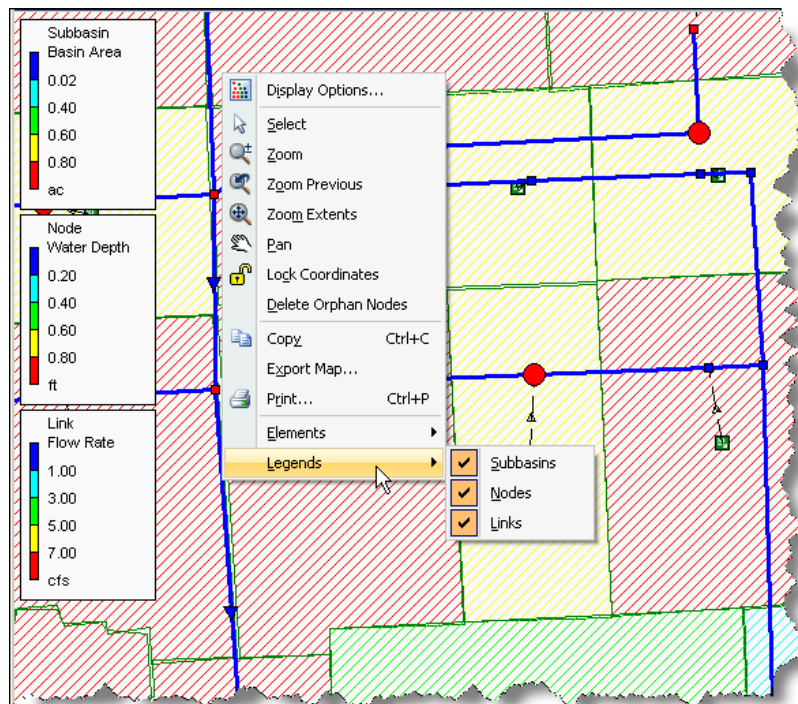

Figure 2.20 To re-display a legend that was turned off, right-click the Plan View and select the legend(s) to turn on or off

To move a legend to another location on the Plan View, click the legend with the left mouse button and drag the legend to its new location and then release the mouse.

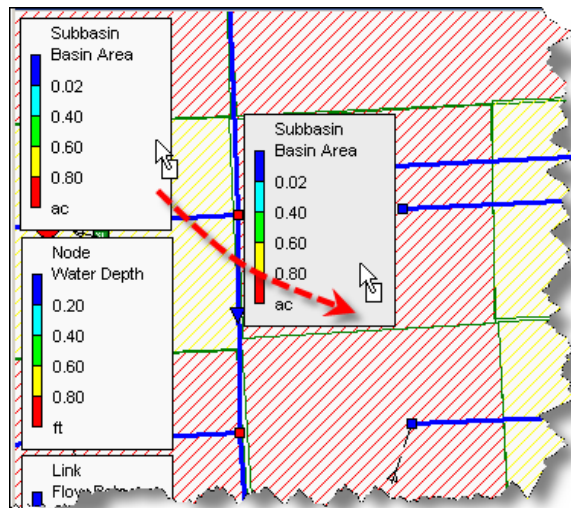

Figure 2.21 To move a legend on the Plan View, click and drag the legend to the new location

To edit a legend, right-click the legend. The software then displays the Legends Options dialog box, as shown in the following figure.

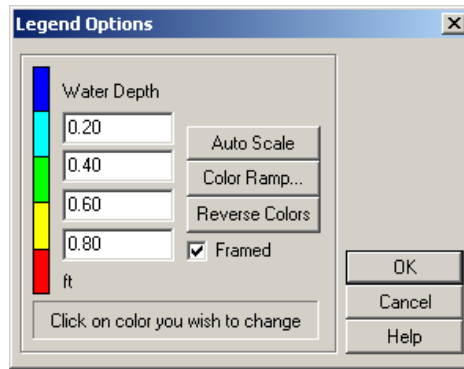

Figure 2.22 To edit a legend, right-click the legend and the software will display the Legend Options dialog box

The Legend Options dialog box allows you to define a set of numerical ranges to which different colors are assigned for viewing a particular parameter for the elements on the Plan View. The following options are available:

- Numerical values, entered in increasing downward order, are used to define the color ranges. Not all four edit fields need values specified.
- To change a color, click its color band in the dialog box. The Color dialog box will be displayed, allowing you to select a new color.
- Click the Auto Scale button to automatically assign ranges based on the minimum and maximum values attained by the parameter being displayed for the current time period.
- Click the Color Ramp button to select from a list of built-in color schemes.
- Click the Reverse Colors button to reverse the ordering of the current selection of colors (the color in the lowest range becomes that of the highest range and vice versa).
- Select the **FRAMED** check box if you want a frame drawn around the legend.

Right-Click Context Menu

To provide you additional ease at using the software, the right-click context menu option is used extensively throughout the software. To display the right-click context menu, click using the right mouse button. An example of the right-click context menu for the Plan View is shown in the following figure.



Figure 2.23 To display the right-click context menu, click with the mouse right button

The available options shown on the right-click context menu can change, based upon the context of what you are pointing at. For example, when pointing the cursor at a junction on the Plan View, only those commands corresponding to junctions are presented in the displayed right-click context menu. Moving the cursor away from any network elements, only commands corresponding to the Plan View are presented in the right-click context menu.

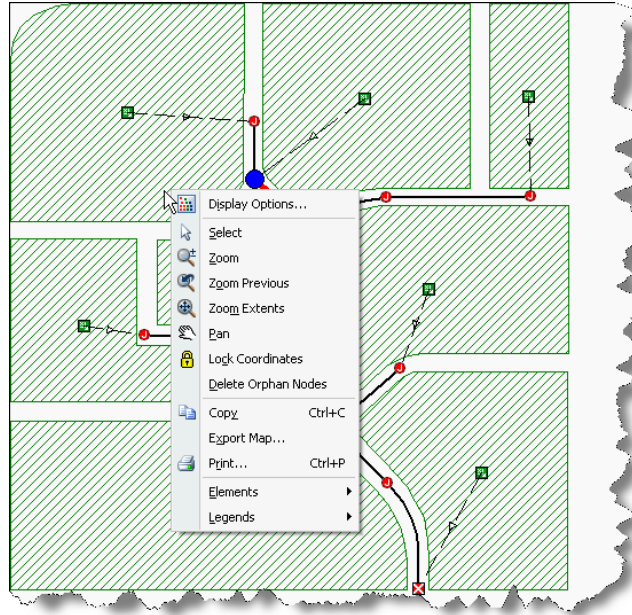

Figure 2.24 The commands displayed on the right-click context menu change context, depending upon what you are pointing at

The right-click context menu is available throughout the software, from the Plan View, Data Tree, Time Series Plot, Profile Plot, etc.

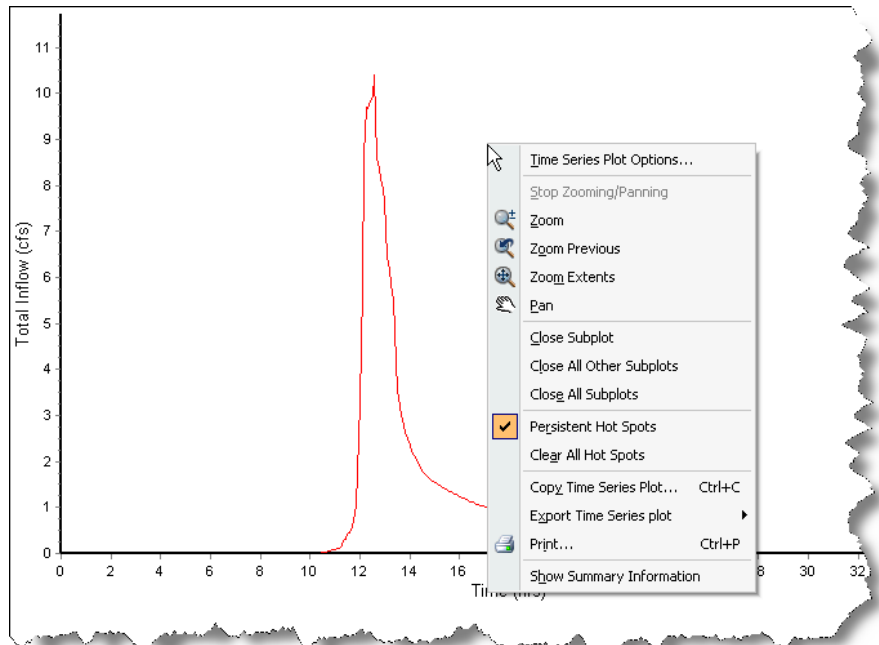



Figure 2.25 The right-click context menu is available throughout the software, and changes depending upon what is being displayed (i.e., Plan View, Data Tree, Time Series Plot, Profile Plot, etc.)

Aerial View

The Aerial View, as shown at the bottom of the Navigation Pane as in the following figure, displays the entire network and identifies the current view with a

rectangular view box. You can use the Aerial View to change the view in the Plan View window quickly by dragging the view box. As you drag the view box to another location, the display in the Plan View will be redrawn accordingly.

To display the Aerial View, select **VIEW > AERIAL VIEW** or click the **AERIAL VIEW**  icon on the standard toolbar. To hide the Aerial View, select **VIEW > AERIAL VIEW** or click the **AERIAL VIEW**  icon again.

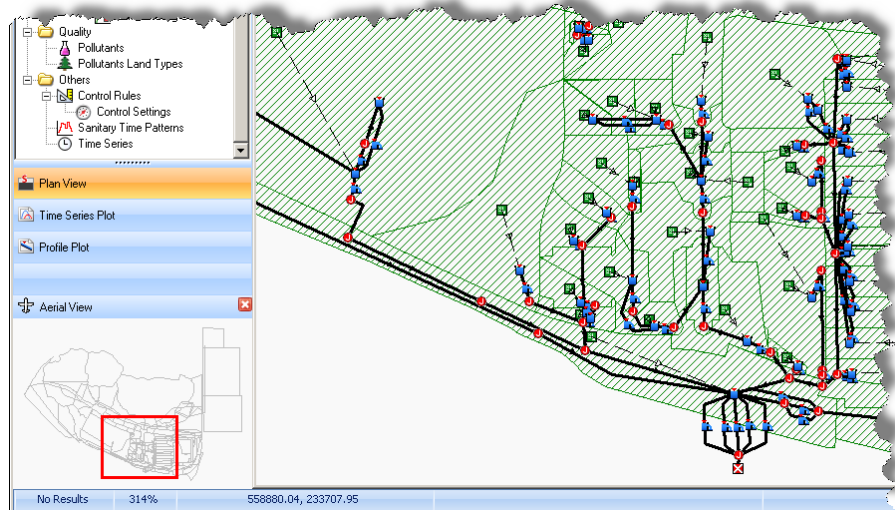

Figure 2.26 The Aerial View allows you to interactively pan about the drainage network while zoomed in.

Defining a Network

3

The Autodesk Storm and Sanitary Analysis software is easy to learn and use. Simulation models can be quickly developed using a variety of different sources. Network components can be imported from CAD and GIS. The network model can be interactively created using a mouse by pointing and clicking. Graphical symbols are used to represent network elements such as manholes, pipes, pumps, weirs, ditches, channels, catchbasin inlets, and detention ponds. The software allows you, at any time, to interactively add, insert, delete, or move any network element, automatically updating the model. For example, selecting and moving a manhole automatically moves all connected pipes, ditches, channels, and pumps.

Pipes can be curvilinear and lengths automatically computed. Scanned aerial orthophoto TIFF images and maps; GIS and CAD files of streets, parcels, and buildings can be imported and displayed as a background image. This feature allows you to quickly digitize a network model, confirm the network layout, or enhance the output modeling results. Moreover, you can point to or click any network manhole, pipe, pump, weir, ditch, channel, catchbasin inlet, or detention pond from the Plan View to quickly determine the defined input data and output modeling results.

Model Representation

The Autodesk Storm and Sanitary Analysis software uses a subbasin-node-link representation to define the numerical model to be analyzed. Subbasins contribute runoff, which then enter nodes. A node can represent a manhole structure, but many other real-world elements can represent a node. From nodes, flow is then routed (or conveyed) along links. A link can be a pipe or an open channel stream, but many other real-world elements can represent a link. A simple representation of a subbasin-node-link network model is shown in the following figure.

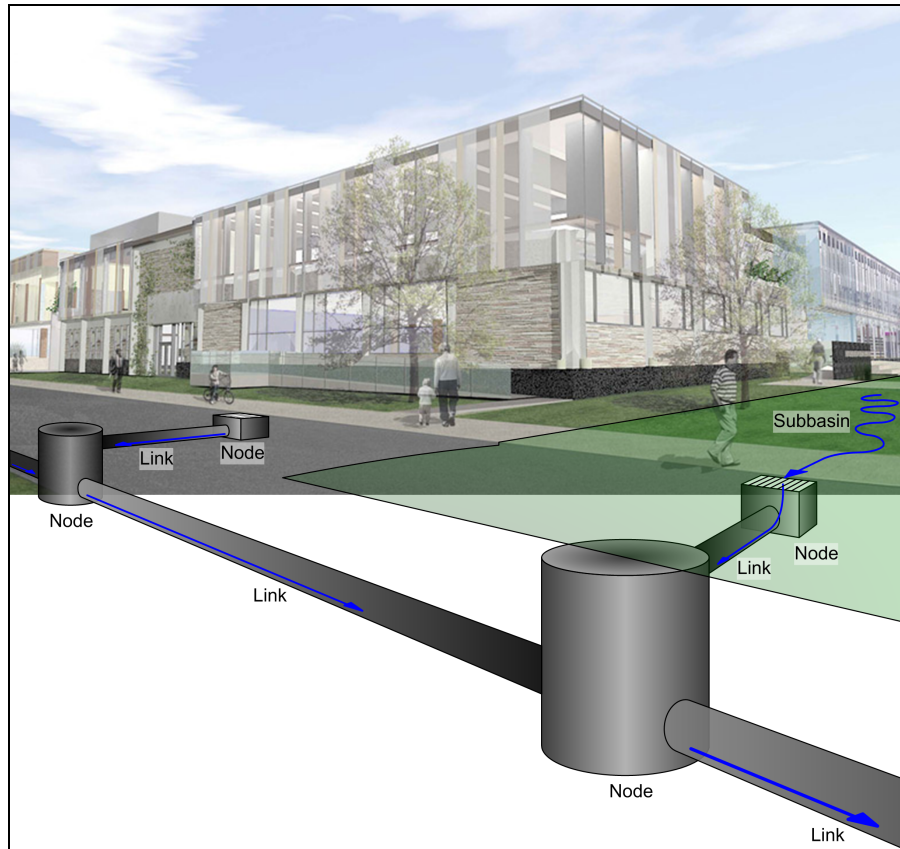

Figure 3.1 Representation of a subbasin-node-link network model

Network Subbasin Elements

A network subbasin is an area of land that captures rainfall and converts a portion of it to runoff, which then drains downhill and enters the network conveyance network consisting of nodes and links. In addition to computing runoff from rainfall, runoff from melting snow and ice can be modeled. The following subbasin network element types can be represented:

- Subbasins, drainage basins, catchment areas, catchment basins, drainage areas, watersheds
- Sewersheds for determining RDII (see page 403)
- Roofs, parking lots, streets, sidewalks, and other impervious areas
- Lake and reservoir surface areas

Network Node Elements

In addition to manhole structures, nodes can represent the following network element types:

- Manhole structures
- Junction boxes, wet wells
- Storm drain inlets, catchbasins
- Wetlands, ponds, detention basins, reservoirs, lakes
- Underground storage structures
- Flow diversion structures
- Internal computational locations along a link (i.e., within a pipe or along a stream channel)
- Sewage discharge locations into the wastewater sewer system
- Terminus nodes (end points of the network model)

Network Link Elements

In addition to pipes and open channel streams, links can represent the following network element types:

- Sewer pipes
- Culverts
- Open channel ditches, streams, or rivers
- Side of roadway gutters
- Grass swales
- Pumps
- Siphons
- Orifices, standpipes, and other detention structures discharge outlets
- Gated (valved) discharge locations
- Controlled and uncontrolled outlets from detention structures

Network Routing

The flow (either stormwater or wastewater) is conveyed through nodes and links of the network model. This flow is ultimately discharged at a terminus node in the network model, called an outfall. Outfall nodes can represent an actual discharge structure, such as a headwall, or can represent a location where you want to terminate the model representation. The outfall should be located far enough downstream from the concerned area being analyzed so that if an inaccurate boundary condition is defined, it will not adversely affect the network model results.

Multiple Networks

More than one pipe network can be contained in the model. The software manages the details of the separate networks. When a network element dialog box is displayed, it will display the elements for all networks. Similarly, when an analysis is performed, it will analyze all networks.

Defining a Network Model

The software allows you to easily develop a stormwater or wastewater network model. As shown in the following figure, choose the appropriate Add Element tool from the Elements toolbar, and then click the Plan View to place the element.

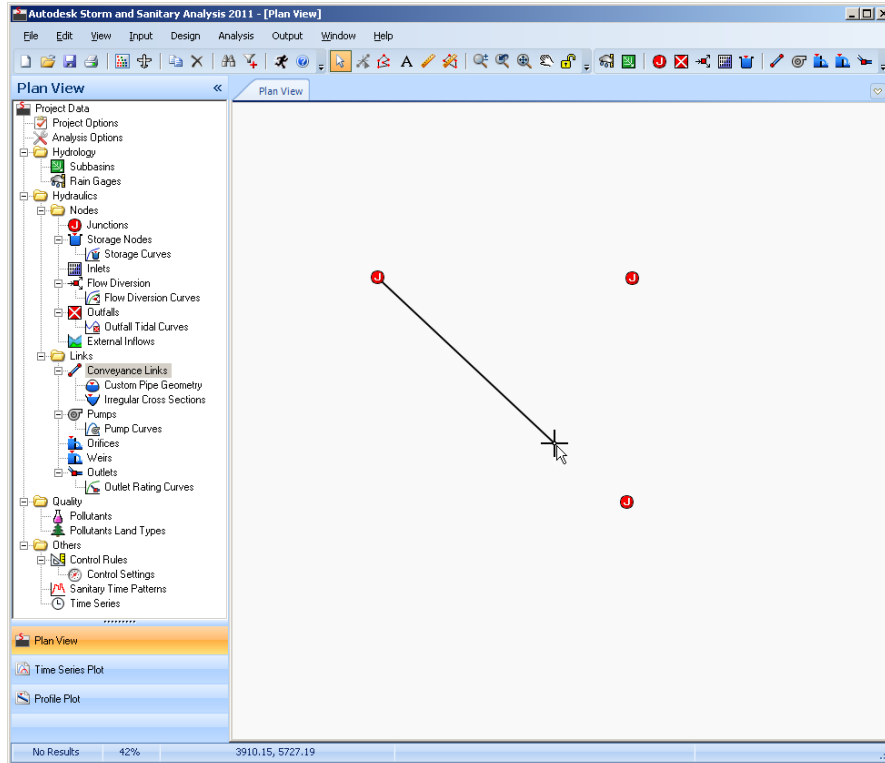

Figure 3.2 Select the appropriate Add Element tool and then click the Plan View to place the element

The software views the network model as a collection of links connected together at their end points by nodes. Links and nodes are identified with ID numbers and can be arranged in any fashion. The following figure shows an example of a drainage network for a proposed commercial retail store development.

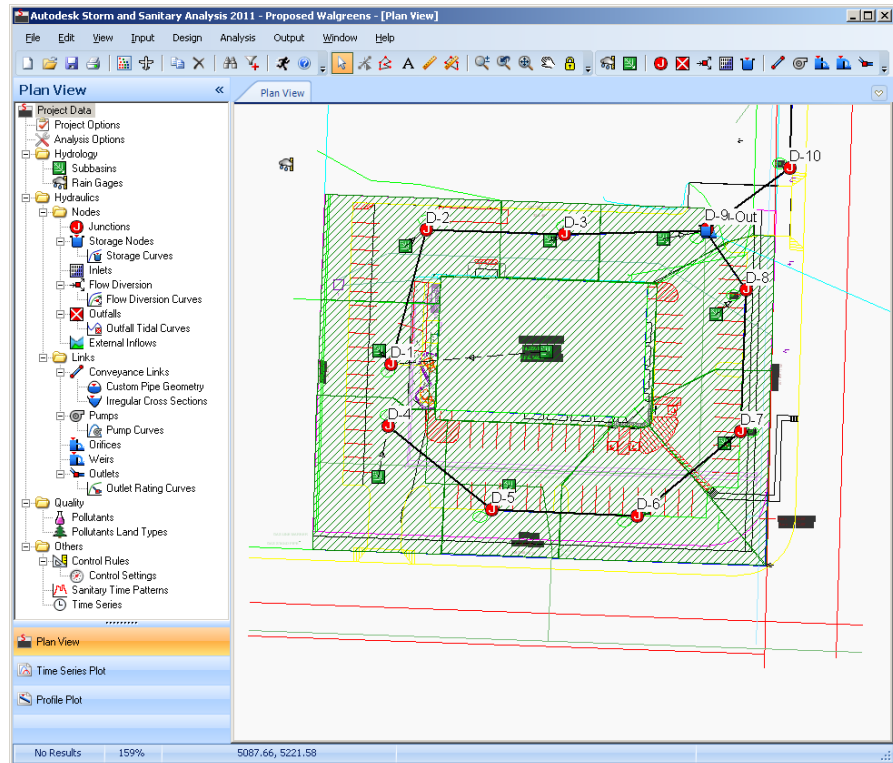

Figure 3.3 Example drainage network of a proposed commercial retail store development

The software conceptualizes a network conveyance system as a series of water (and optionally, pollutant) flows between network elements. These network elements include:

- *Rain Gages* can be used to represent precipitation inputs to the system.
- *Subbasins* are used to receive the precipitation from rain gages. Optionally, the subbasins can account for infiltration into the groundwater aquifer, which can then be further modeled to account for the change in the groundwater elevation. To model pollutant flows, the subbasin areas can take into account surface runoff and pollutant loadings, which can then be further modeled in the hydraulic routing.
- *Groundwater Aquifers* receive infiltration from subbasins and can optionally transfer a portion of this inflow to hydraulic routing within the network conveyance system.
- *Conveyance Elements* consists of links (i.e., channels, pipes, pumps, and flow regulators) that model the transport of water between nodes (i.e., manholes, junctions storage areas, treatment facilities, and outfalls).
- *Inflows* are flows that enter the network, and can originate from surface runoff, groundwater interflow, sanitary dry weather flow, or from user-defined hydrographs.

Not all stormwater elements need to appear in a network model. For example, storm precipitation can be assigned to a model without using a rain gage (see the section titled *Storm Selection* on page 76 for more details).

Schematic Network vs. Mapped Network

The network can be defined as either a schematic representation of the model, or mapped to real world coordinates. As long as the network element data is properly defined, the analysis results will be identical.

Typical Steps in Building a Network Model

The following steps are typically used in constructing a network model:

- 1 Define the default options and element properties to use in the analysis model.
- 2 Draw a network representation that represents the physical elements of the study area.
- 3 Edit the properties of the elements that make up the system.
- 4 Define the analysis options.
- 5 Run the analysis.
- 6 View the analysis results.

The following sections describe how to define the various elements of a network.

Defining a Subbasin

Subbasins are hydrologic areas of land whose topography and drainage system elements direct surface runoff to a single discharge point. Subbasins are described in detail in Chapter 9.

To add a subbasin to the drainage network:

- 1 Click the **ADD SUBBASIN**  icon from the Elements toolbar.
- 2 On the Plan View, click the mouse to draw a polygon outline of the subbasin. Click to define each vertex of the subbasin polygon.
- 3 While creating the subbasin boundary, it is not unusual to make a mistake digitizing by clicking at the wrong location.

Press the Backspace key to delete the last segment. Alternatively, right-click and select **DELETE LAST SEGMENT** from the displayed context menu.

Press the Esc key to cancel the command. Alternatively, right-click and select **CANCEL** from the displayed context menu.
- 4 Double-click or press Enter to complete the polygon. Alternatively, right-click and select **DONE** from the displayed context menu. The software will automatically close the polygon and draw the subbasin on the Plan View.

Note that pressing the Esc key while defining the subbasin cancels the command.

Defining a Node

Nodes include the following network elements:

 Junctions

 Outfalls

 Flow Diversions

 Inlets

 Storage Nodes

Each of these network node elements are described in detail in Chapters 7 and 8. Note that nodes must be added to the network before links (e.g., channels, pipes, pumps, etc.) can be added. This is because links connect the nodes to other nodes.

To add a node to the network:

- 1 Click the appropriate Add Element tool from the Elements toolbar.
- 2 Move the mouse to the desired location on the Plan View and click. The node will be placed at the clicked location.
- 3 You can continue to add the same element type until you press the Esc key or choose another command.

Inserting a New Node into an Existing Link

A node, such as a junction, inlet, or flow diversion, can be inserted into an existing link, thereby splitting the link into two separate links. The invert and rim elevations of the inserted node will automatically be interpolated from the upstream and downstream nodes that connect to the link being split. In addition, the split link invert elevations will be interpolated where they connect to the inserted node.

To add insert a node to into a network link:

- 1 Click the appropriate Add Node tool from the Elements toolbar.
- 2 Move the mouse to the desired location along the link in the Plan View and click.
- 3 The software prompts you to confirm that you want to insert the node into the existing link. Select OK.

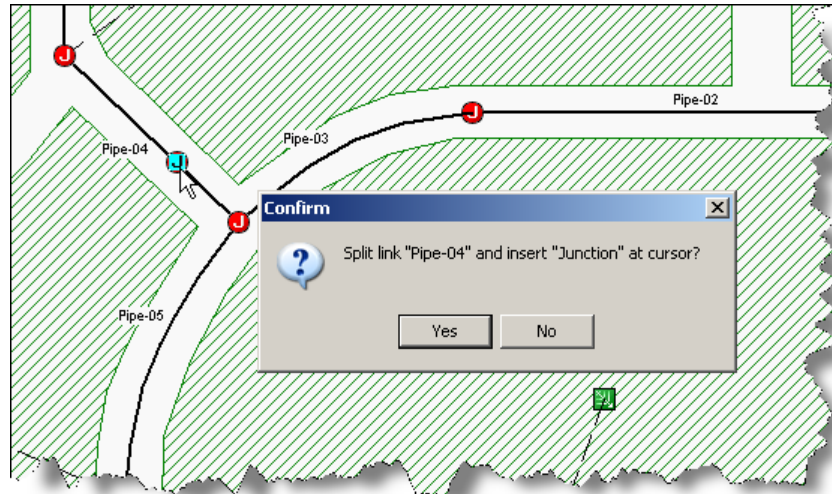







Figure 3.4 The software will confirm that you want to split the existing link to insert the new node

- 4 The node is inserted into the link at the clicked location.

Defining a Link

Links include the following network elements:

-  Conveyance Links (channels, pipes & culverts)
-  Pumps
-  Orifices
-  Weirs
-  Outlets

Each of these network link elements are described in detail in Chapters 7 and 8. Note that links are connected to nodes. Therefore, nodes (e.g., junctions, storm drain inlets, storage nodes, outfalls, flow diversions, etc.) must be added to the network model before links can be added.

To add a link to the network:

- 1 Click the appropriate Add Element tool from the Elements toolbar.
- 2 On the Plan View, click the inlet (upstream) node.
- 3 As you move your mouse, you will notice that there will be a rubber-banding line from the inlet node.
- 4 To account for bends in the link alignment, click to define intermediate alignment vertices.

- While creating the link, it is not unusual to make a mistake digitizing by clicking at the wrong location.

Press the Backspace key to delete the last segment. Alternatively, right-click and select **DELETE LAST SEGMENT** from the displayed context menu.

Press the Esc key to cancel the command. Alternatively, right-click and select **CANCEL** from the displayed context menu.

- Click the outlet (downstream) node. The software then draws the link between the selected nodes.

Note that pressing the Esc key while defining the link cancels the command.

Alternative Definition

Alternatively, network link elements can be added using the appropriate element dialog box. For example, to add a pipe, select **INPUT ► CONVEYANCE LINKS**. This displays the Conveyance Links dialog box, as shown in the following figure. Then, click the Add button to create a new link in the network model. Once the inlet and outlet nodes have been defined, the link element appears on the Plan View.

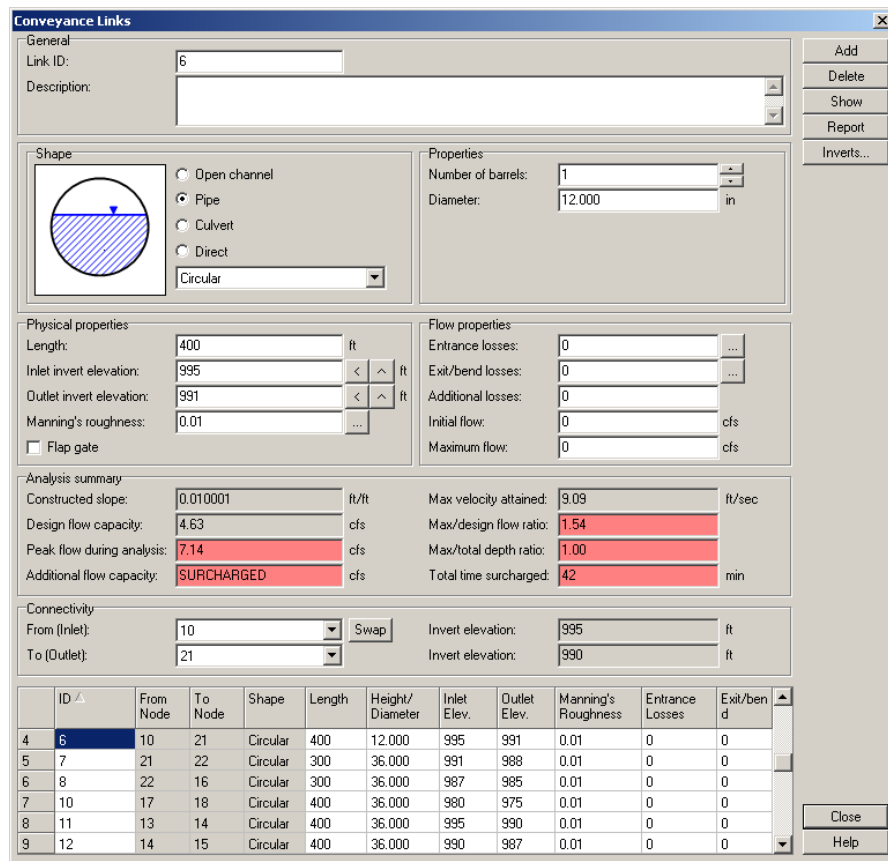



Figure 3.5 Network link elements can also be added using the appropriate element dialog box, such as this Conveyance Links dialog box

Defining a Rain Gage

Rain gages supply rainfall data for one or more subbasins in the study area. To add a rain gage to the network:

- 1 Click the **ADD RAIN GAGE**  icon from the Elements toolbar.
- 2 On the Plan View, click where you want the rain gage to be placed. As shown in the following figure, the rain gage does not need to be placed near to the basin(s) that it applies to.

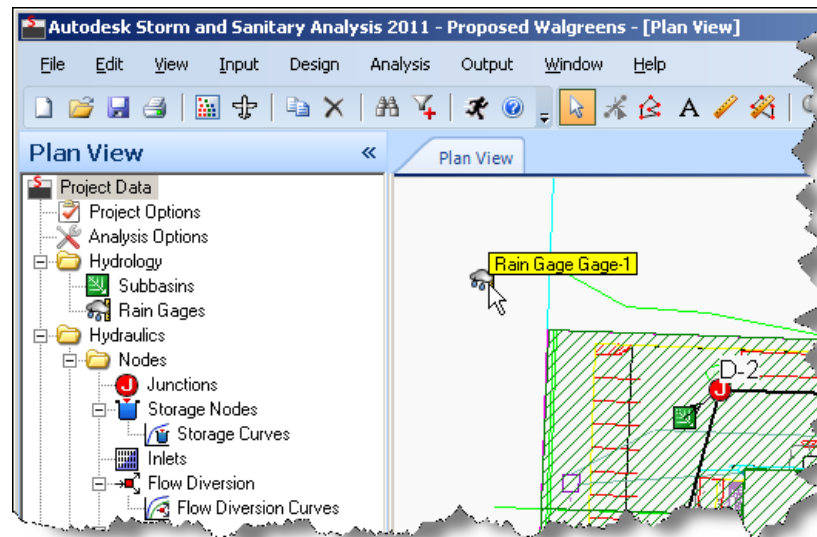

Figure 3.6 Rain gages do not need to be located near the basin(s) that they apply to

Defining a Hidden Rain Gage

Rain gages can be defined so that they do not display on the Plan View (i.e., hidden). Select **INPUT ► RAIN GAGES** to display the Rain Gages dialog box, as shown in the following figure. Then, click the Add button to create a new rain gage. The rain gage will be created without being displayed on the Plan View.

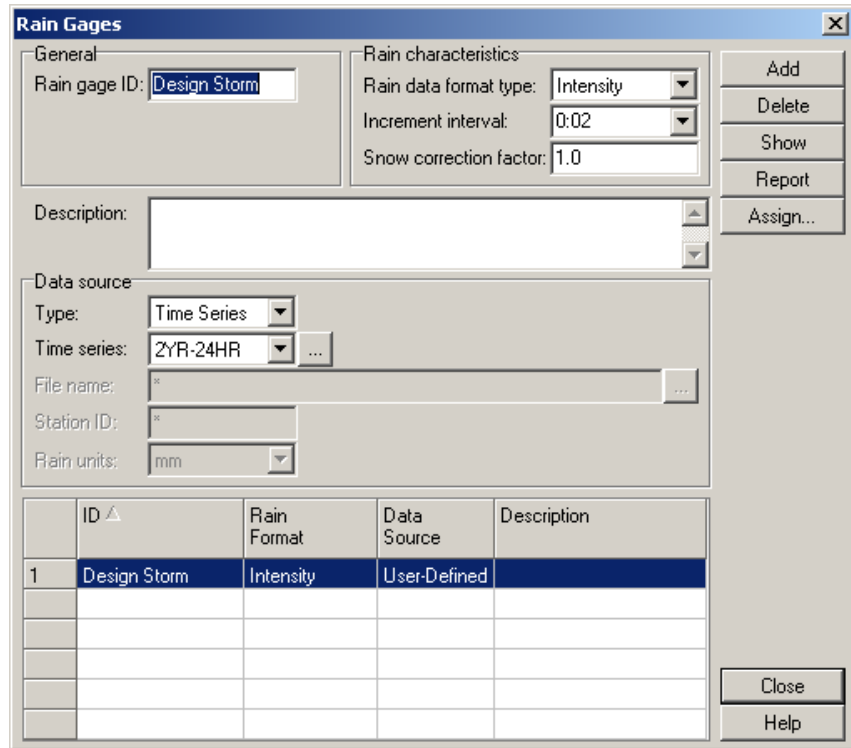

Figure 3.7 Rain gages can be defined using the Rain Gages dialog box, and then they do not display on the Plan View

Displaying a Hidden Rain Gage

For rain gages that were created without being displaying on the Plan View (i.e., hidden), the following method can be used to assign map coordinates to them so that they display on the Plan View:

- 1 Display the Rain Gages dialog box by selecting **INPUT ► RAIN GAGES**.
- 2 From the Rain Gages dialog box, select the associated rain gage record in the list of rain gages at the bottom of the dialog box that you want to assign coordinates for.
- 3 With the left mouse button held down, as shown in the following figure, drag the rain gage record from the dialog box to the location you want it placed on the Plan View.

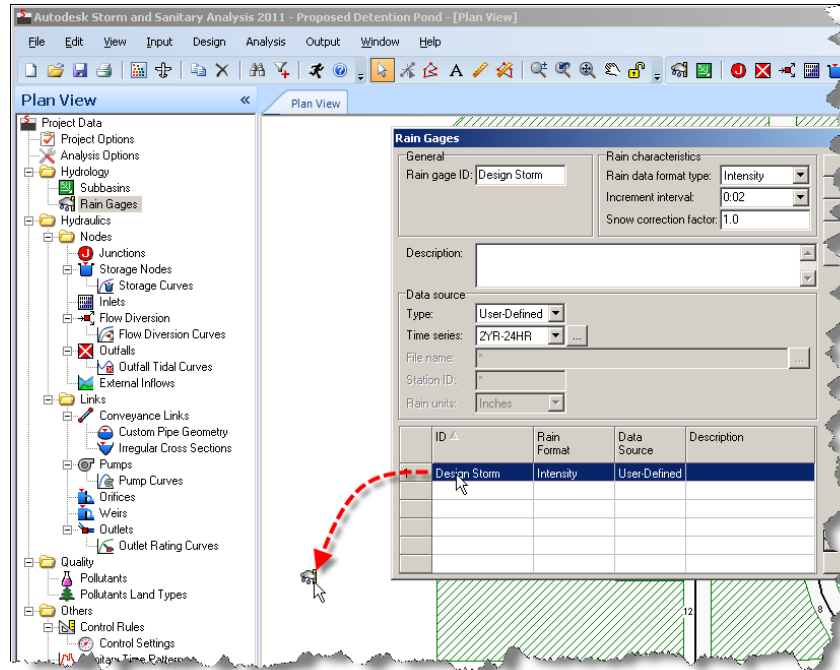

Figure 3.8 Drag the rain gage record to the location on the Plan View

- 4 Release the mouse button. The rain gage is assigned the map coordinates of the selected location and displays on the Plan View.

Hiding a Displayed Rain Gage

To hide the display of rain gages that are already displayed on the Plan View:

- 1 Display the Plan View Display Options dialog box by selecting **VIEW ► DISPLAY OPTIONS**. Alternatively, click the **DISPLAY OPTIONS** icon from the Standard toolbar. Or, right-click the Plan View and select **DISPLAY OPTIONS** from the context menu.
- 2 From the Display Options dialog box, un-select the Rain Gages check box. Then, click OK. The rain gage will no longer be displayed on the Plan View.
- 3 To redisplay the rain gage, select the Rain Gages check box in the Display Options dialog box.

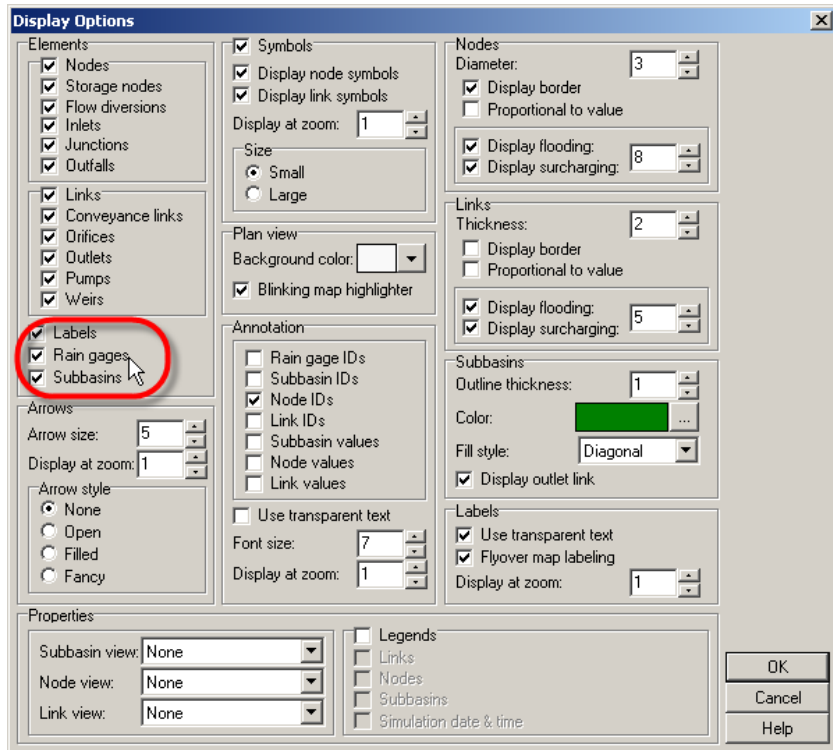

Figure 3.9 The display of rain gages can be turned on and off using the Display Options dialog box

Directly Assigning Storm Precipitation

Instead of defining a rain gage and assigning it to the subbasins in a model, you can directly assign the storm to be analyzed using the Analysis Options dialog box. See the section titled *Storm Selection* on page 76 for more information.

Adding Map Labels

The **ADD LABEL A** tool can be used to create a single line of text anywhere on the Plan View. To add text to the Plan View:

- 1 Click the **ADD LABEL A** tool from the Elements toolbar.
- 2 On the Plan View, click where you want text to be placed.
- 3 Enter the text for the label.
- 4 Press the Enter key to set the label (or the Esc key to cancel).
- 5 The label will be placed on the Plan View.

Editing Map Labels

To change the text, size, or font of an existing map label:

- 1 Click the **SELECT ELEMENT**  tool from the Map toolbar.
- 2 On the Plan View, select the label you want to change.

- 3 Right-click and select **LABEL PROPERTIES** from the displayed context menu. As shown in the following figure, the software displays the Label Properties dialog box, allowing you to change the text label and properties.

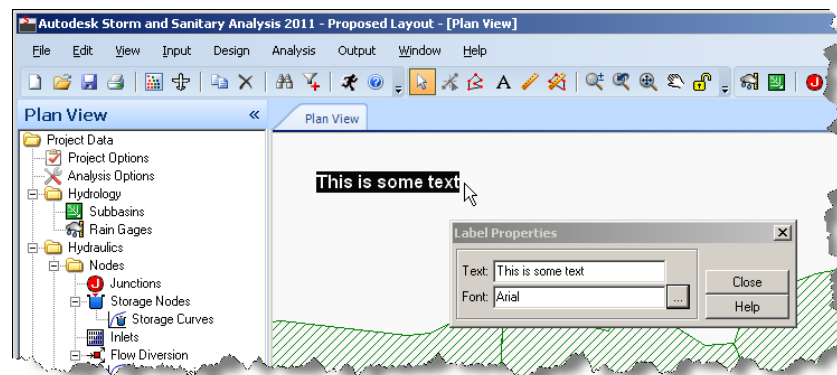



Figure 3.10 Existing text labels and properties can be changed as needed

- 4 Click the  browse button to display the Font dialog box. This dialog box allows you to choose the font, font style, and size for the label.

Moving a Map Label

Click the **SELECT ELEMENT**  tool from the Map toolbar to move a map label to a new location on the Plan View. Using this tool, select the label to move. You can then drag the label to its new location.

Copying Map Label Formatting

Note that once the formatting has been defined for a map label, its formatting can be copied to other map labels. See the section titled *Copying and Pasting Element Properties* on page 55 for instructions.

Adding Non-Visual Input Data

To define stormwater input data that are not displayed on the Plan View, such as irregular cross sections, unit hydrographs, land uses, select the appropriate item from the Input Menu or Data Tree, as shown in the following figure. The software then displays the corresponding input dialog box, allowing you to define the data.

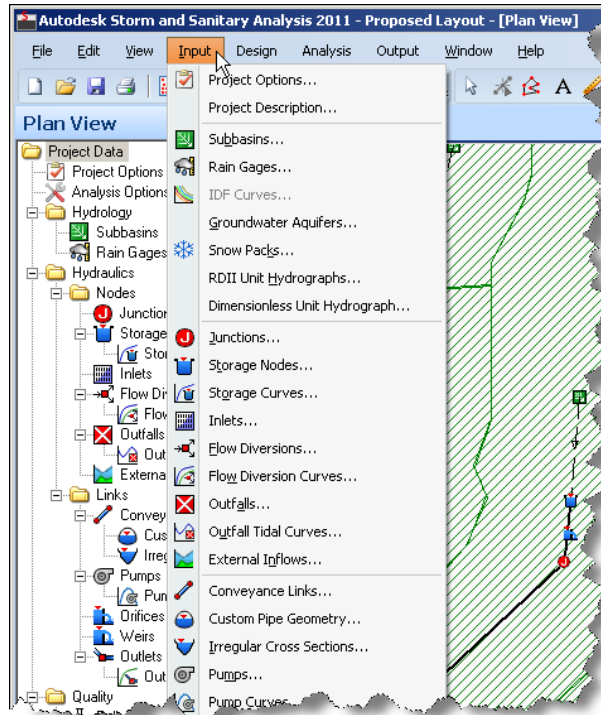





Figure 3.11 Stormwater non-displayed input data are defined using the appropriate Input Menu or Data Tree item

Selecting and Moving Elements

To select a network element from the Plan View:

- 1 Make certain that the mouse cursor is in selection mode. The mouse cursor should have the shape of an arrow. If not, then click the **SELECT ELEMENT**  tool from the Map toolbar or choose **EDIT ► SELECT ELEMENT**.
- 2 Click the mouse on the desired element from within the Plan View.
- 3 The selected element blinks to denote that it has been selected.

Rain gages, subbasins, and nodes can be moved from one location to another in the Plan View, as long as coordinates are not locked. If the coordinates are locked, the **LOCK COORDINATES**  icon on the Map toolbar will look like a locked padlock. Clicking this icon will unlock the coordinates and cause the icon  to appear as being unlocked.

To move an element:

- 1 Click the node element to move from the Plan View.
- 2 Holding down the left mouse button, drag the element to its new location.
- 3 Release the mouse button.

Editing Node Coordinates

For more precise control over the location of a network node element, use the Edit Coordinate command, as described below:

- 1 Click the **SELECT ELEMENT**  tool from the Map toolbar or choose **EDIT > SELECT ELEMENT**.
- 2 Right-click the element and then select **EDIT COORDINATES** from the displayed context menu.

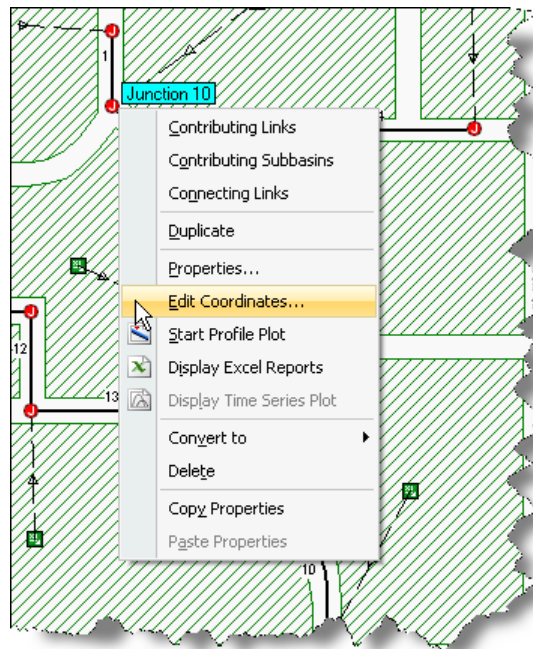

Figure 3.12 Right-click the element and select **Edit Coordinates** from the displayed context menu

- 3 The Edit Coordinates dialog box is displayed for the selected element. You can then enter the precise X, Y map coordinates for the element and click OK. The software then moves the element to these coordinates.

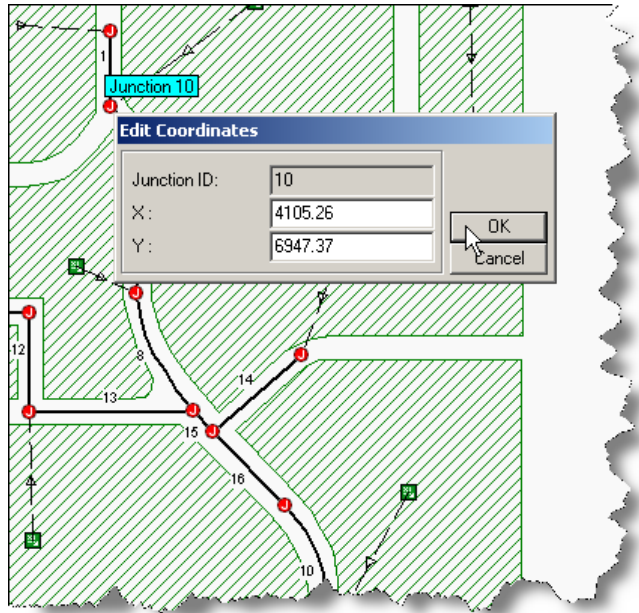



Figure 3.13 Enter the precise X, Y map coordinates for the network element

Editing Network Elements

The following sections describe various ways of editing the network.

Selecting and Editing an Element

To edit a network element from the Plan View:

- 1 Click the **SELECT ELEMENT**  tool from the Map toolbar or choose **EDIT > SELECT ELEMENT**.
- 2 From within the Plan View, double-click the desired element to be edited.
- 3 The associated element dialog box is displayed with the selected element current allowing you to edit its properties. For example, double-clicking a junction displays the Junctions dialog box with the selected junction current.

Alternative Method

Alternatively, network element data can be edited from the associated element dialog box by selecting the appropriate element item from the Input Menu. For example, to edit a junction select **INPUT > JUNCTIONS** to display the Junctions dialog box. Then, select the row within the element table for the element you wish to edit. Alternatively, click the element from the Plan View to it will be selected in the dialog box. You can then edit the properties of the selected element.

Converting Elements to Other Element Types

The software allows you to convert a node or link from one type to another without having to first delete the element and add a new one in its place. For example, the software allows you to convert an Outfall node to a Junction node, or convert a Weir link to an Orifice link. Note that nodes can only be converted to other node types, and, likewise, links can only be converted to other link types.

To convert a network element displayed on the Plan View:

- 1 Click the **SELECT ELEMENT**  tool from the Map toolbar or choose **EDIT > SELECT ELEMENT**.
- 2 From within the Plan View, select the element to be converted.
- 3 Right-click to display a context menu, as shown in the following figure. From the context menu select the new type of node or link to convert to.

The element is converted to the new element type.

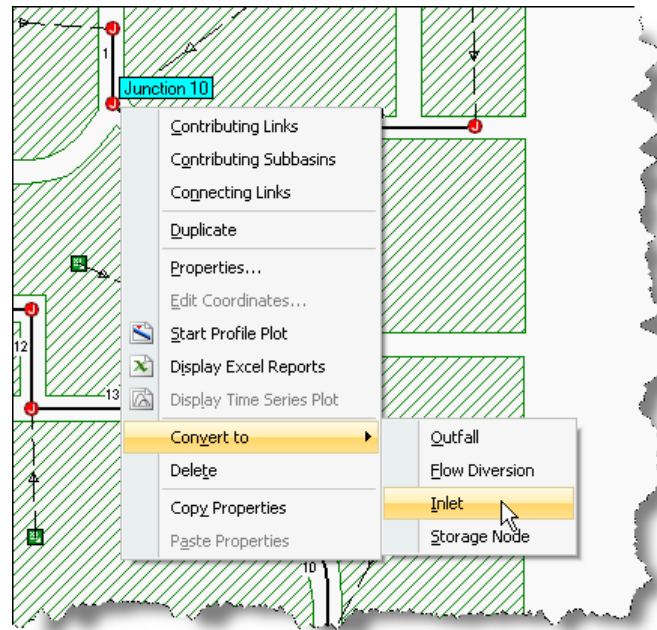

Figure 3.14 The software allows you to convert network elements to other element types

Preserved Data Properties

Only data properties that are common to both element types will be preserved after the element is converted. For nodes, the following data is preserved after the element is converted:

- Element ID
- Map Coordinates
- Description
- External Inflows
- Treatment Functions
- Invert Elevation

For links, the following data is preserved after the element is converted:

- Element ID
- From and To Nodes
- Description

Duplicating Network Elements

Many times it is necessary for you to lay out several network node elements, such as manholes or storm drain inlets, that are essentially identical (other than a rim or invert elevations). The software allows you to quickly duplicate already defined elements.

To duplicate nodal elements:

- 1 Click the **SELECT ELEMENT**  tool from the Map toolbar or choose **EDIT ► SELECT ELEMENT**.
- 2 From within the Plan View, right-click the nodal element to be duplicated.
- 3 From the displayed context menu, as shown in the following figure, select **DUPLICATE**.

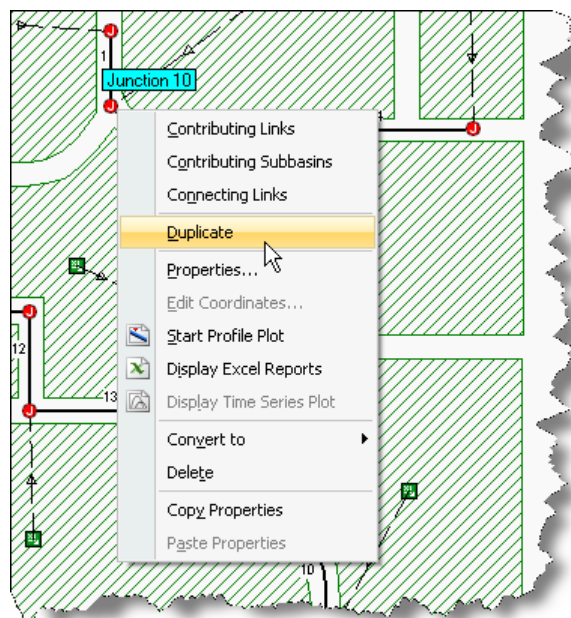

*Figure 3.15 Select the element to be duplicated, right-click and select **Duplicate** from the displayed context menu*

- 4 Then, locate the cursor to the location on the Plan View that the nodal element is to be duplicated, and then click. The software then places the new nodal element at the selected location.

Copying and Pasting Element Properties

The software allows you to copy and paste the properties from one network element to another element of the same type.

To copy and paste properties from one element to another:

- 1 Click the **SELECT ELEMENT**  tool from the Map toolbar or choose **EDIT ► SELECT ELEMENT**.
- 2 From within the Plan View, right-click the element whose properties are to be copied.

- From the displayed context menu, as shown in the following figure, select **COPY PROPERTIES**.

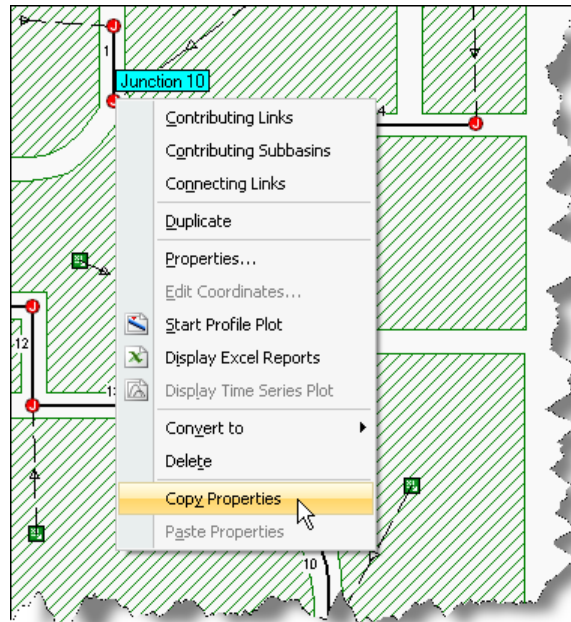

Figure 3.16 Copy the properties from one element type

- Right-click the element where you want these properties copied to. This element type must be of the same type that the properties were copied from.
- From the displayed context menu, as shown in the following figure, select **PASTE PROPERTIES**.

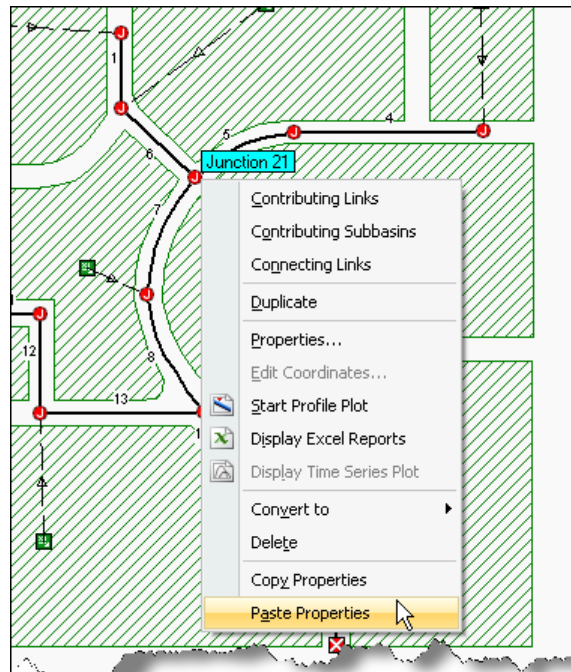

Figure 3.17 And then paste the properties to the new element

- 6 The properties will be pasted into the new element.

Properties Not Copied

Only data that can be shared between elements of the same type can be copied and pasted. For Map Labels, only font properties are copied and pasted. In addition, the following properties are *not* copied:

Subbasins

- Element ID
- Description
- Area
- Outlet Node

Nodes

- Element ID
- Description
- Map Coordinates
- Invert Elevation
- Max/Rim Elevation (*or Offset*)
- WSEL Elevation
- Surcharge Elevation
- Diverted To Node (*for Flow Diversions*)



Links

- Element ID
- Description
- From Node and To Node
- Invert Elevation (*or Offset*)
- Length

Reshaping Network Elements

Channels and pipes are drawn as multi-segment polylines containing any number of vertices that define the curvature of the polyline. Similarly, subbasins are drawn as polygons containing any number of vertices that define the polygon shape. Once a channel, pipe, or subbasin has been drawn on the Plan View, vertices that define these elements can be moved, added, or deleted.

To edit the vertices that define a channel, pipe, or subbasin:

- 1 Click the **SELECT ELEMENT**  tool from the Map toolbar or choose **EDIT** ► **SELECT ELEMENT**.
- 2 Click the subbasin, channel, or pipe to edit.
- 3 Change to *Vertex Editing* mode by clicking the **EDIT VERTICES**  tool, selecting **EDIT** ► **EDIT VERTICES**, or right-clicking the element and choosing **EDIT VERTICES** from the displayed context menu.

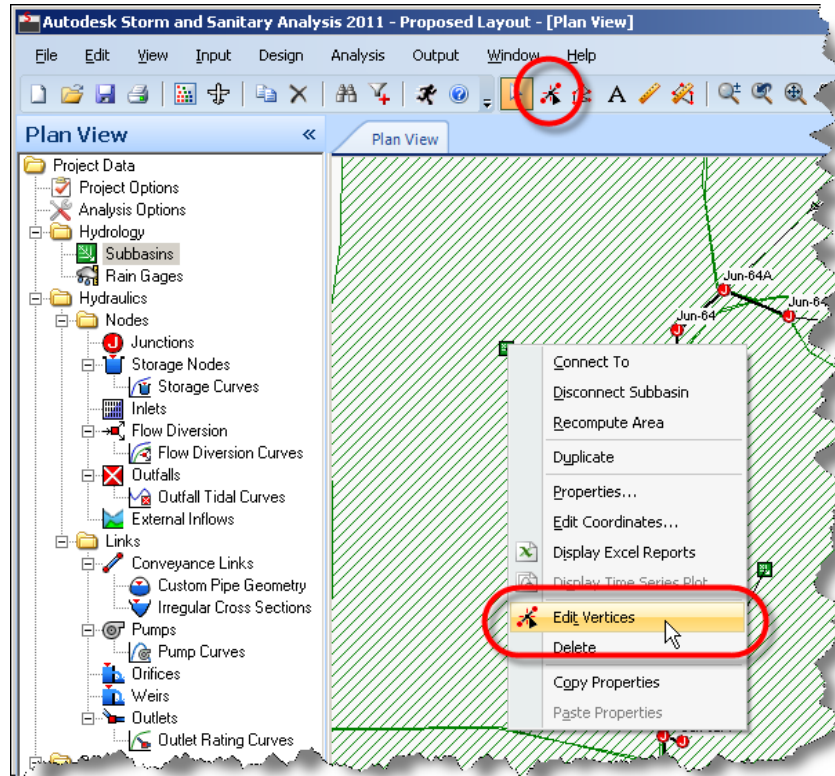

Figure 3.18 Change to Vertex Editing mode

- 4 The mouse pointer changes into an arrow tip, and all vertices on the selected network element are displayed as small squares. The currently selected vertex is displayed as a filled square. To select a particular vertex, click it.

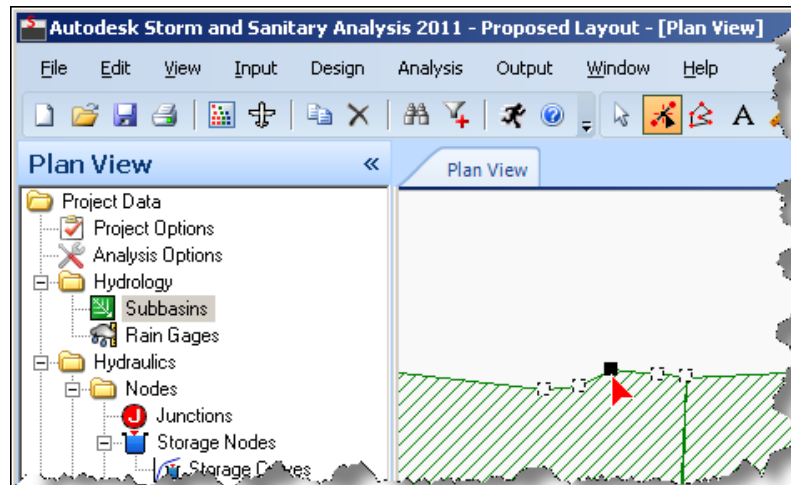

Figure 3.19 Click the vertex to select it and move it to a new location

- 5 To move a vertex to another location, select the vertex and drag it to its new location.
- 6 To add a new vertex, right-click and select **ADD VERTEX** from the displayed context menu or press the Insert key. A vertex is added adjacent to the selected vertex.

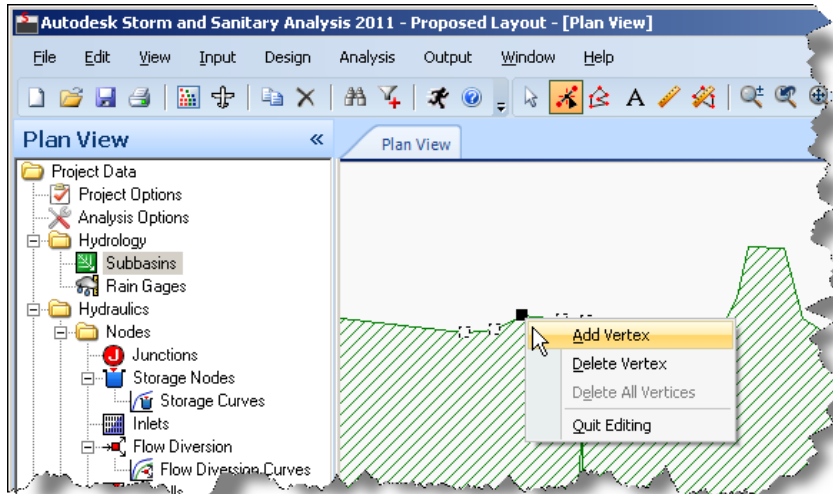



Figure 3.20 Vertices can be added to deleted to the existing network element

- 7 To delete the currently selected vertex, right-click and select **DELETE VERTEX** from the displayed context menu or press the Delete key. The vertex is removed.
- 8 While in *Vertex Editing* mode, you can begin editing the vertices for another network element by clicking the element.
- 9 To leave *Vertex Editing* mode, right-click and select **QUIT EDITING** from the displayed context menu or select another tool from the toolbar. Alternatively, press the Esc key.

Reversing a Network Element Direction

Link elements, such as channels, pipes, pumps, weirs, orifices, and outlets, are defined with an upstream and downstream node defined, thereby denoting the defined flow direction for the element. Typically, link elements should be oriented so that the upstream end of the element is at a higher elevation than that of the downstream end.

To reverse the link element's defined flow direction:

- 1 Click the **SELECT ELEMENT**  tool from the Map toolbar or choose **EDIT ► SELECT ELEMENT**.
- 2 Right-click the channel, pipe, pump, weir, orifice, or outlet to reverse the flow direction for, and select **REVERSE DIRECTION** from the displayed context menu.

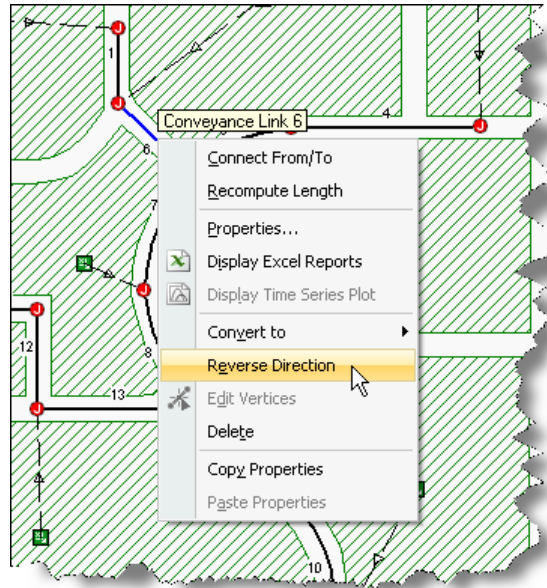

*Figure 3.21 Reverse the defined flow direction of the selected network by right-clicking and then selecting **Reverse Direction** from the displayed context menu*

- 3 Alternatively, double-click the network element to display the associated network element dialog box. As shown in the following figure, click the Swap button to reverse the direction of the element.

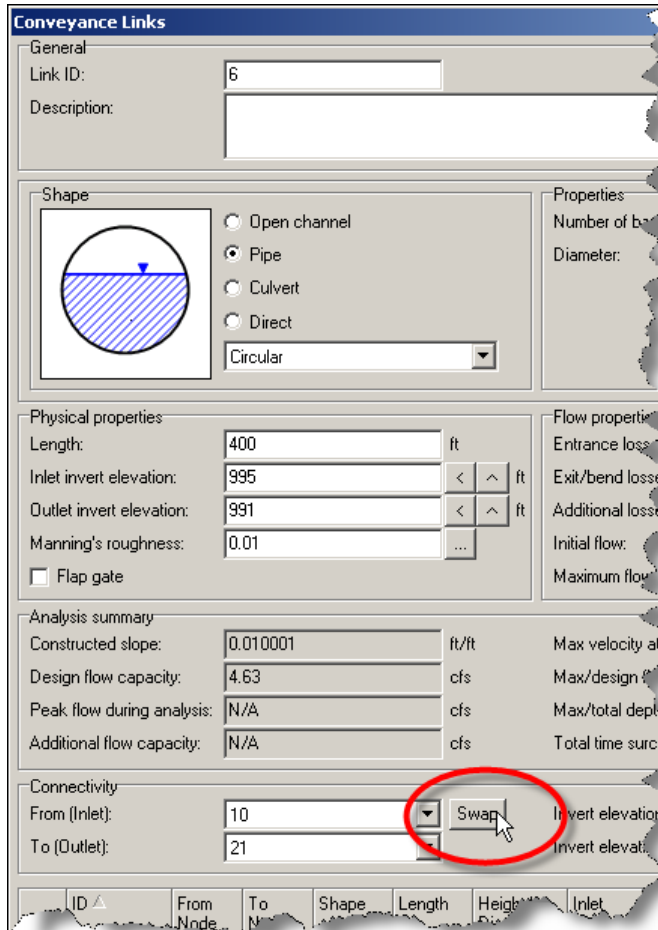



Figure 3.22 Click the **Swap** button in the network element dialog boxes to reverse the flow direction of a link

Finding Elements

The software allows you to search for an element in the Plan View if the element ID is known.

To search for an element:

- 1 Click the **FIND**  icon from the Standard toolbar or choose **EDIT > FIND**.
- 2 The software then displays the Find dialog box. From the **ELEMENT TYPE** dropdown list, select the type of element to search for.

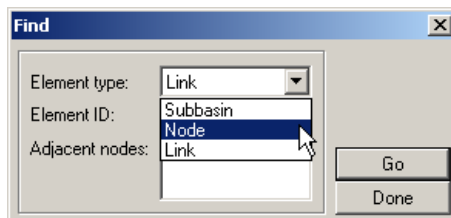

Figure 3.23 Select the element type and element ID to search for

- Next, enter the ID of the element to search for and click Go. If the element exists, it will be highlighted on the map. If the Plan View is zoomed in and the element falls outside of the current view boundaries, the view will be panned so that the element can be seen. In addition, any adjacent elements will be displayed in the Find dialog box.

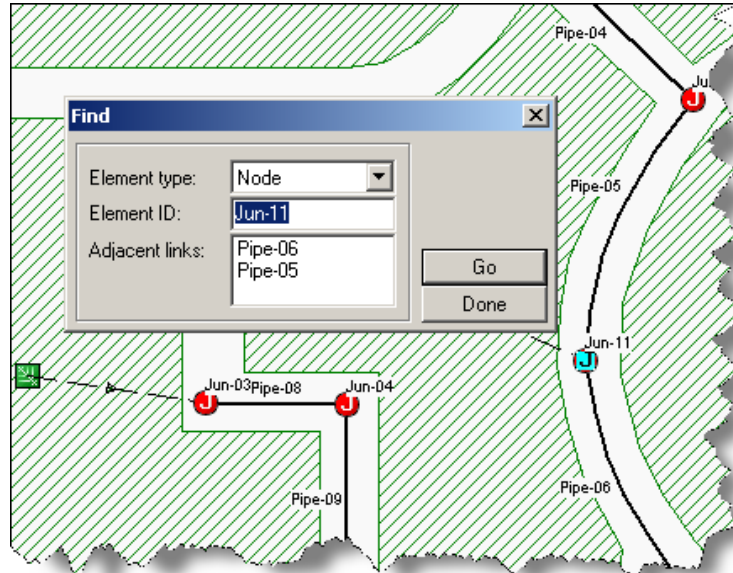

Figure 3.24 The software will zoom the Plan View to where the element is located, highlight the element, and display any adjacent links

- After a successful search, the software lists the following results in the Find dialog box:
 - The outlet connections for a searched subbasin
 - The connecting links for a searched node
 - The connecting nodes for a searched link

Element IDs Not Case Sensitive

Note that element IDs are not case sensitive. Therefore, **JUN-104** is equivalent to **Jun-104**.

Querying Elements

The software allows you to query for elements in the Plan View that meet a specified criteria. For example, you can ask the software to map all nodes which have a flood depth of greater than 1 ft, links with a flow velocity greater than 3 ft/sec, etc.

To perform a query:

- Click the **QUERY**  icon from the Standard toolbar or choose **EDIT > QUERY**.
- The software then displays the Query dialog box.

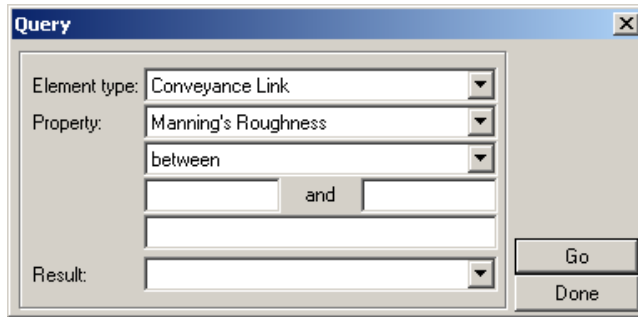

Figure 3.25 Select the Element Type to run a query on

- 3 From the **ELEMENT TYPE** drop-down list, select the type of element to query (i.e., subbasins, junctions, channels, pipes, etc.).

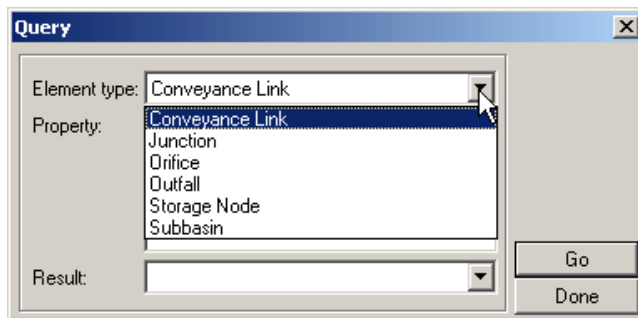

Figure 3.26 Select the Element Type to run a query on

- 4 From the **PROPERTY** drop-down list, select the property to query. Note that element output properties (i.e., Total Inflow, etc.) are only available after the analysis has been performed.
- 5 From the **OPERATOR** drop down list, select the comparison operator to use. The following comparison operators are available:
 - Between
 - Not Between
 - Equal To
 - Not Equal To
 - Greater Than
 - Less Than
 - Below
 - Greater Than or Equal To
 - Less Than or Equal To
- 6 In the **VALUE** field(s), enter the value(s) to compare against and click Go.

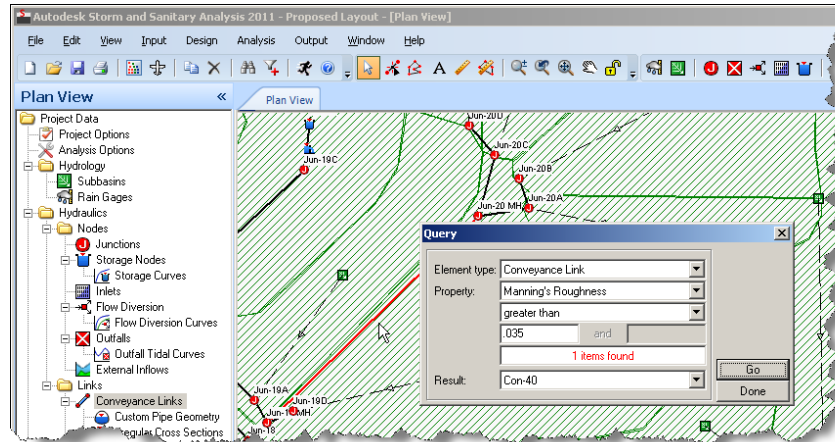



Figure 3.27 The software will display those elements that meet the specified criteria, and will allow you to run repeated queries on the model while you are updating element values

- 7 After a successful query, those elements that meet the specified criteria will be highlighted on the Plan View. In addition, the number of elements found that meet the specified criteria will be listed in the **RESULT** field.
- 8 If you change the analysis output time step, then the query results are automatically updated in the Plan View.
- 9 While the Query dialog box is displayed, you can change the query and have results automatically updated in the Plan View.
- 10 Once the Query dialog box is closed, the Plan View will revert back to its original display.

Editing Multiple Elements

The software allows you to select a group of elements in the Plan View and edit a common property for them. For example, one could select all of the pipes within a region and set the pipe roughness to be used.

To edit multiple elements:

- 1 Click the **SELECT POLYGON**  tool from the Map toolbar or choose **EDIT ► SELECT POLYGON**.
- 2 Draw a polygon on the Plan View around the elements that you want to edit by clicking each point of the polygon.
- 3 While creating the polygon, it is not unusual to make a mistake digitizing by clicking at the wrong location.

Press the Backspace key to delete the last segment. Alternatively, right-click and select **DELETE LAST SEGMENT** from the displayed context menu.

Press the Esc key to cancel the command. Alternatively, right-click and select **CANCEL** from the displayed context menu.

- 4 Close the polygon selection by either double-clicking or pressing Enter. Alternatively, right-click and select **DONE** from the displayed context menu.
- 5 Next, select **EDIT ► GROUP EDIT**. The Group Edit dialog box is displayed.

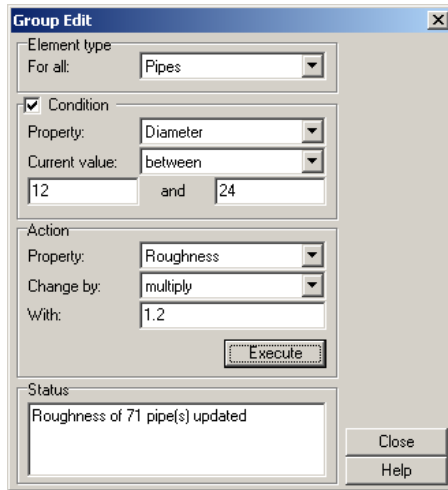

Figure 3.28 Group Edit dialog box allows you to edit a common property of the selected elements

- 6 From the **ELEMENT TYPE** drop-down list, select the type of element (i.e., subbasins, junctions, channels, pipes, etc.) which you want to edit.
- 7 Optionally, a property filter can be used to restrict which elements are edited. To filter the elements based upon a particular property value, select the check box for the **CONDITION** section of the dialog box.

Then, from the **PROPERTY** drop-down list, select the property to filter against. The property being filtered does not have to correspond to the property being modified.

Then, from the **CURRENT VALUE** drop-down list, select one of the available comparison filter operators:

- Between
- Not Between
- Equal To
- Not Equal To
- Greater Than
- Less Than
- Below
- Greater Than or Equal To
- Less Than or Equal To

Then, specify the value(s) to filter against.

- 8 In the Action section of the dialog box, select the property to edit from the **PROPERTY** drop-down list. The selected property being modified does not have to correspond to the same property being filtered.
- 9 Select the operation function in the **CHANGE BY** drop-down list to apply to the selected property. For numerical properties, you have an option to replace, multiply, add, subtract, or divide the existing value of the property. For non-numerical properties, only the replace value option is available.

- 10 Specify the value that should be replaced, multiplied, added, subtracted, or divided to the existing value for the selected elements. Some properties will show the browse button for displaying a specialized property dialog box.
- 11 Click Execute and the software will make the specified changes to the selected elements.
- 12 After a successful group edit command, the number of elements that met the specified criteria and were successfully edited will be displayed in the **STATUS** field.
- 13 While the Group Edit dialog box is displayed, you can change the group edit criteria and execute another update command.
- 14 Click Close when finished.

Deleting Multiple Elements

The software allows you to select a group of elements in the Plan View to delete. For example, you could select a proposed extension to an existing stormwater network for deletion.

To delete multiple elements:

- 1 Click the **SELECT POLYGON**  tool from the Map toolbar or choose **EDIT ► SELECT POLYGON**.
- 2 Draw a polygon on the Plan View around the elements that you want to delete by clicking each point of the polygon.
- 3 While creating the polygon, it is not unusual to make a mistake digitizing by clicking at the wrong location.

Press the Backspace key to delete the last segment. Alternatively, right-click and select **DELETE LAST SEGMENT** from the displayed context menu.

Press the Esc key to cancel the command. Alternatively, right-click and select **CANCEL** from the displayed context menu.
- 4 Close the polygon selection by either double-clicking or pressing Enter. Alternatively, right-click and select **DONE** from the displayed context menu.
- 5 Select **EDIT ► GROUP DELETE**. The Group Delete dialog box is displayed.

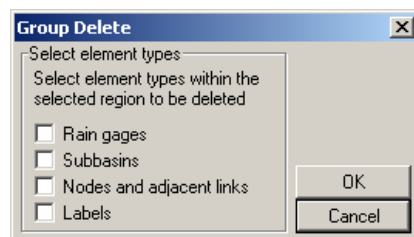

Figure 3.29 Group Delete dialog box allows you to filter which network elements are to be deleted

- 6 From the Group Delete dialog box, select the element types which you want to delete. If you select the **NODES AND ADJACENT LINKS** option, this will include all node element types such as junctions, outfalls, flow diversions, and storage nodes, and any connected link types such as channels, pipes, pumps, weirs, orifices, and outlets.
- 7 Click OK and the selected elements are deleted.

Network Transformation

The Transform Network dialog box, as shown in the following figure, allows the defined network to be moved, elevated, or scaled according to a specified transformation. Select **DESIGN ► NETWORK TRANSFORMATION** to display the Transform Network dialog box.

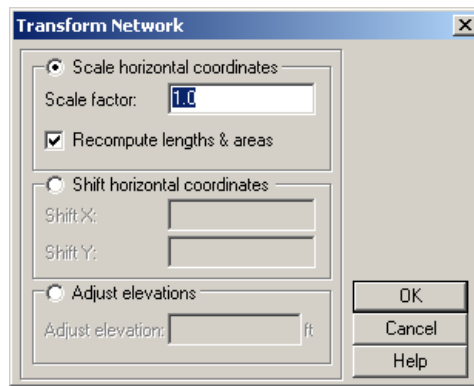

Figure 3.30 The Transform Network dialog box allows the defined network to be moved, elevated, or scaled according to a specified transformation

The Transform Network command can perform the following transformation operations:

Scale Horizontal Coordinates

This option scales the network horizontal coordinates equally in the X and Y directions. A value less than 1.0 causes the network to be scaled smaller; a value greater than 1.0 causes the network to be scaled larger. This option also includes the ability to automatically recompute pipe and channel lengths and subbasin areas.

Shift Horizontal Coordinates

This option shifts the network in the horizontal plane, and is useful when you need to horizontally translate a network so that it aligns with a standard coordinate system.

Adjust Elevations

This option raises the network node and link elevations up and down by a specified amount, and is useful when trying to have the defined network elevations match a particular datum.

Network Analysis

4

After a stormwater or sanitary (wastewater) sewer network model has been defined, an analysis of the network model can be performed. This chapter describes how to specify options to be used in the analysis, how to run the analysis, and how to troubleshoot common problems that might occur during an analysis.

Analysis Options

The Analysis Options dialog box, shown in Figures 4.1 and 4.4, defines the computational analysis options to use when performing a stormwater or wastewater simulation. Select **ANALYSIS > ANALYSIS OPTIONS** or double-click the **ANALYSIS OPTIONS**  icon from the data tree to display the Analysis Options dialog box.

The Analysis Options dialog box contains a tabbed interface, allowing you to specify various computational parameters within the same dialog box. Click the tab of interest to see the data defined within the tabbed pane.

General

The General tabbed pane of the Analysis Options dialog box is used to define the simulation time steps, simulation dates, hydrodynamic routing parameters, and any external interface files to be used.

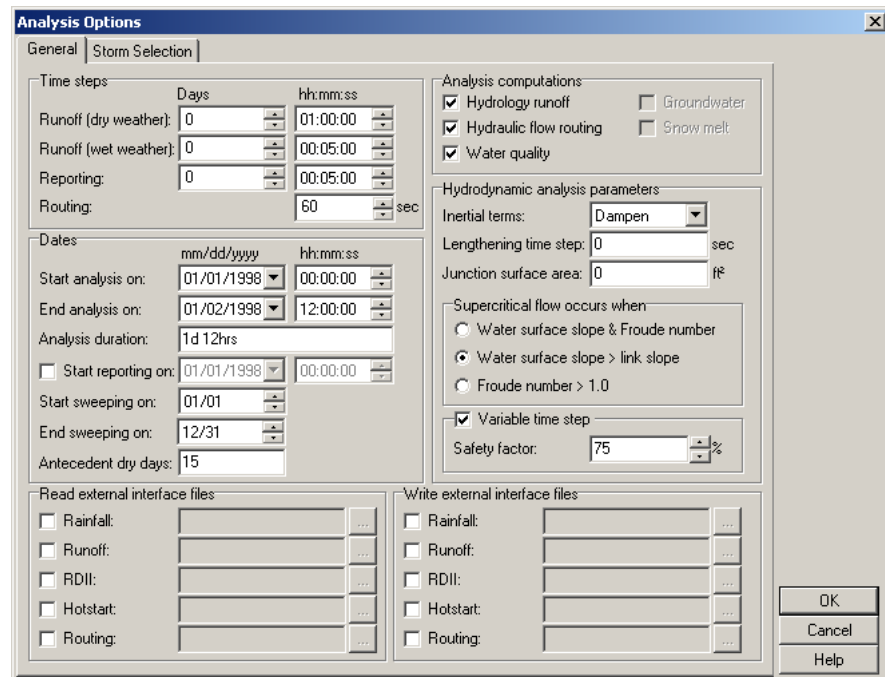

Figure 4.1 The Analysis Options dialog box, General tabbed pane

The following sections are provided in the General tabbed pane for defining the computational options to be used in performing a stormwater or wastewater simulation.

Time Steps

The Time Steps section establishes the time step length to be used for the runoff computations, routing computations, and results reporting. Time steps are specified in **DAYS** and **HOURS:MINUTES:SECONDS** format, except for flow routing which is entered in decimal seconds.

Runoff (Dry Weather) Time Step

Enter the time step length used for runoff computations (consisting essentially of pollutant buildup) during periods when there is no rainfall and no ponded water. This time step value must be greater or equal to the Runoff (Wet Weather) Time Step value.

Runoff (Wet Weather) Time Step

Enter the time step length used to compute runoff from subbasins during periods of rainfall or when ponded water still remains on the surface.

Reporting Time Step

Enter the time interval for reporting the computed results. This should be equal to or a multiple of the Runoff (Wet Weather) Time Step.

Routing Time Step (seconds)

Enter the time step length in decimal seconds used for routing flows and water quality constituents through the conveyance system. Note that Hydrodynamic Routing method requires a much smaller time step than the other flow routing methods (i.e., Kinematic Wave Routing and Steady Flow Routing). Typical values for a Hydrodynamic Routing range from 60 seconds down to 1 second. However, routing time steps less than 1 second can be manually entered.

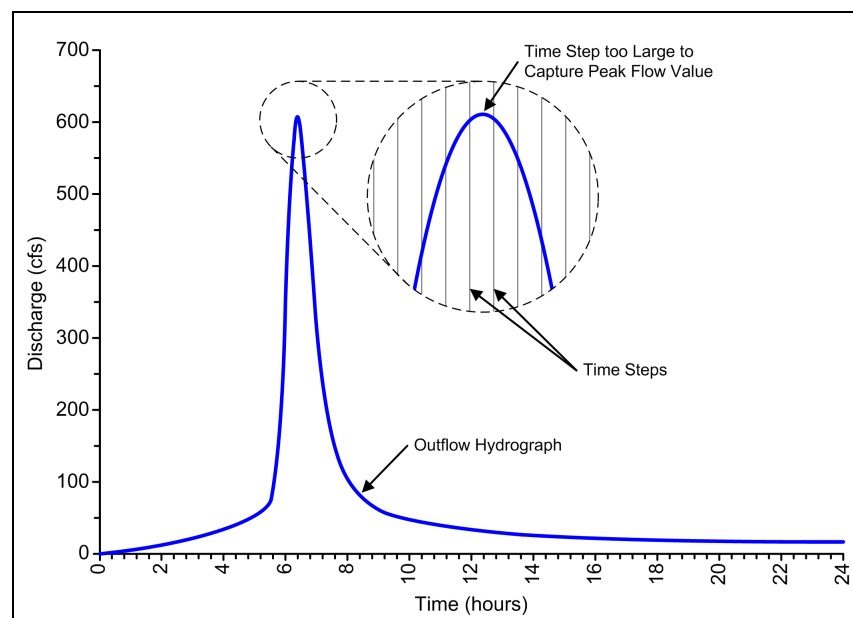

Figure 4.2 A small enough routing time step is required to capture the peak flow value

Dates

The Dates section defines the starting and ending dates/times of a simulation.

Start Analysis On

Enter the date (**MONTH/DAY/YEAR**) and time of day when the simulation begins. If rainfall or climate data are read from external files, then the simulation dates should be specified to coincide with the dates defined in these external files.

Note that clicking the (v) drop-down button will display a calendar selection dialog box, allowing you to interactively select the date to start the simulation on.

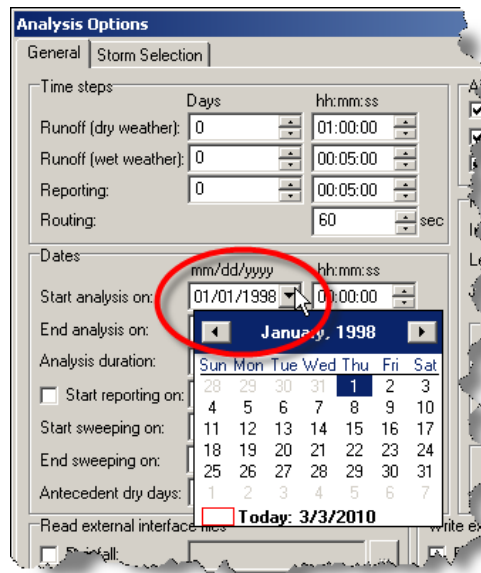

Figure 4.3 Selecting the drop-down button will display a calendar selection dialog box

End Analysis On

Enter the date (**MONTH/DAY/YEAR**) and time of day when the simulation is to end.

For example, if performing a 24-hour storm simulation, then set the date field equal to one day after the **START ANALYSIS ON** date field and set the time field in both entries to **00:00:00**.

Analysis Duration (read-only)

This read-only field shows the specified analysis duration, by subtracting the specified **START ANALYSIS ON** date and time from the **END ANALYSIS ON** date and time.

Start Reporting On (optional)

This optional entry allows you to define the date (**MONTH/DAY/YEAR**) and time of day when reporting of simulation results is to begin. To define a starting date and time, first enable the check box at the front of the entry. Note that the specified date and time must be on or after the simulation starting date and time. Unchecking this entry (or leaving this entry blank) causes reporting to start when the simulation begins. By default, this entry is unchecked.

Note that you may want to have the reporting date and time be later on during the simulation. This will allow you to initially run the model in a steady-state mode so that the model network stabilizes before the storm event occurs. Hence, you would want to specify the reporting date and time to coincide with the start of the storm.

Start Sweeping On (water quality modeling only)

Enter the day of the year (**MONTH/DAY**) when street sweeping operations begin. The default is January 1. This entry is ignored if not performing a water quality simulation.

End Sweeping On (water quality modeling only)

Enter the day of the year (**MONTH/DAY**) when street sweeping operations end. The default is December 31. This entry is ignored if not performing a water quality simulation.

Antecedent Dry Days (water quality modeling only)

Enter the number of days without rainfall prior to the start of the simulation. This value is used to compute the initial pollutant buildup for the subbasins. This entry is ignored if not performing a water quality simulation.

Analysis Computations

The Analysis Computations section controls which computations should be included (or ignored) when performing an EPA SWMM hydrology analysis. For all other hydrology methods, this section is unavailable (grayed out). The hydrology method is selected in the Project Options dialog, as described on page 166.

Note that if there are no elements in the project needed to model a given process, then that analysis computation option is disabled. For example, if there are no aquifers defined, then the **GROUNDWATER** check box will appear disabled in an unchecked state.

Hydrology Runoff

Uncheck this option to ignore all rainfall data and runoff computations. The software will only consider user-specified direct inflow time series and dry weather (sanitary) inflow data. In addition, the Storm Selection tabbed pane in this dialog box will be unavailable.

Hydraulic Flow Routing

Uncheck this option to ignore all hydraulic routing computations. This allows you to review only the hydrology from the model.

Water Quality

Uncheck this option to ignore all water quality computations. This allows the model to speed up when you need to only review the hydrology and hydraulics of a model.

Groundwater

Uncheck this option to ignore all groundwater computations. This allows you to review the effects of groundwater on the model's hydrology. For example, a model that contained groundwater components could be first run with the groundwater computations turned on and then again with them turned off. The analysis results of the two models could then be compared to see the effect of groundwater on the model.

Snow Melt

Uncheck this option to ignore all snow melt computations. This allows you to review the effects of snow melt on the model's hydrology. For example, a model that contained snow melt components could be first run with the snow melt computations turned on and then again with them turned off. The analysis results of the two models could then be compared to see the effect of snow melt on the model.

Hydrodynamic Analysis Parameters

The Hydrodynamic Analysis Parameters section controls how the Hydrodynamic Routing method computations are to be performed. These parameters can greatly influence the stability of the model when it encounters flow complexities. A description on how to improve model stability is included below.

These parameters have no effect for the other routing methods (i.e., Steady Flow Routing and Kinematic Wave Routing).

Inertial Terms

This drop-down list allows you to select how the inertial terms in the St. Venant momentum equation will be handled for different flow conditions. The following options are available:

- | | |
|---------------|-------------------------------------------------------------------------------------------------------------------------------|
| Keep | Maintains the inertial terms at their full value under all conditions. |
| Dampen | Default value. Reduces the inertial terms as flow comes closer to being critical and ignores them when flow is supercritical. |
| Ignore | Drops the inertial terms altogether from the momentum equation, producing what is essentially a Diffusion Wave solution. |

Note that if the model results appear to be unstable (highly variable over a short period of time) while this value is set to **DAMPEN**, then try changing this value to **IGNORE** to see if it assists in stabilizing the model.

Lengthening Time Step

This is a time step, in seconds, used to artificially lengthen channel and pipe links so that they meet the Courant stability criterion under full-flow conditions (i.e., the travel time of a wave will not be smaller than the specified conduit lengthening time step). As this value is decreased, fewer channel and pipe links will require lengthening. A value of 0 means that no channel and pipe links will be lengthened (i.e., will be using their defined length values).

Note that if the model results appear to be unstable (highly variable over a short period of time), then increasing this value will tend to make the model more stable. For example, try using a value of 60 (1 minute) and see if the model results become more stable. If the model results are stable, try reducing this value to the minimum possible while keeping the model stable. On the other hand, if the model results are not stable, then continue to increase this value up to a maximum of 300 (5 minutes). If the model is not stable at this increased value, then there is something else causing the model instability.

The ratio of the artificial length to the original length for each channel and pipe is listed in the Conduit Flow Summary Table contained in the ASCII Output Report.

Junction Surface Area

This is the surface area used at junction nodes when computing changes in water depth. If 0 is entered, then the default value of 12.566 ft² (1.167 m²) is used (the area of a 4 ft diameter manhole). The value entered should be in square feet for US units or square meters for SI metric units.

Supercritical Flow Occurs When

This radio button list allows you to select the basis used to determine when supercritical flow occurs in a conduit. The following options are available:

- Water surface slope & Froude number (default)
- Water surface slope is greater than the conduit slope
- Froude number at either end of the conduit is greater than 1.0

The topmost choice, which checks for either condition, is the recommended option.

Variable Time Step

This check box allows you to indicate whether or not a variable time step should be internally computed. The variable time step is continually recomputed in order to satisfy the Courant stability criterion for each channel and pipe and to prevent an excessive change in water depth at each node. The defined **SAFETY FACTOR** is then used to compute the variable time step.

The computed variable time step will not be less than 0.5 seconds nor be greater than the specified **ROUTING TIME STEP**. If the **ROUTING TIME STEP** is set to less than 0.5 seconds, then this variable time step option is ignored.

Safety Factor

This is a safety factor, which ranges between 10% and 200%, is applied to the variable time step computed from the Courant stability criterion. A typical adjustment factor would be 75% to provide some margin of conservatism. It only applies when the **VARIABLE TIME STEP** option is checked.

Read/Write External Interface Files

The Read/Write External Interface Files section controls if and what analysis interface files should be used during the simulation. The software can use several different kinds of interface files that contain either externally imposed inputs (e.g., rainfall or inflow/infiltration hydrographs) or the results of previously run analyses (e.g., runoff or routing results). These files can help speed up simulations, simplify comparisons of different loading scenarios, and allow large study areas to be broken up into smaller areas that can be analyzed individually.

The different types of interface files that are available include:

Rainfall Interface File

The rainfall interface file is a binary file created internally by the software that can be saved and reused from one analysis to the next.

The rainfall interface file assembles each of the separate rain gage external files used in a simulation into a single rainfall data file. Normally during a simulation, the software creates a temporary file of this type when a model uses external rainfall data file(s). This temporary file is then deleted after the analysis is completed. However, if the same rainfall data are being used with

many different analyses, requesting the software to save the rainfall interface file after the first run and then reusing this file in subsequent runs can save computational time.

The rainfall interface file should not be confused with a rainfall data file. The rainfall interface file is a binary file created internally by the software that processes all of the rainfall data files used by a project. The rainfall data file is an external text file that provides rainfall time series data for a single rain gage.

Runoff Interface File

The runoff interface file is a binary file created internally by the software that can be saved and reused from one analysis to the next.

The runoff interface file can be used to save the runoff results generated from a simulation run. If runoff results will not change in future runs, you can request that the software use this interface file to supply runoff results without having to repeat the runoff computations again.

RDII Interface File

The RDII Interface File is a text file that contains a time series of rainfall-dependent infiltration/inflow flows for a specified set of network system nodes. RDII (rainfall-dependent infiltration/inflow) is used in analyzing sanitary or combined sewer systems. Additional information on RDII is contained in the section titled *RDII Unit Hydrographs* on page 411.

This file can be generated from a previous analysis run when the unit hydrographs and nodal RDII inflow data have been defined for the project, or it can be created outside of the software using some other source of RDII data (e.g., through measurements or output from a different computer program). The format of the file is the same as that of the **INFLOWS INTERFACE FILE**, where **FLOW** is the only variable contained within the file.

Hotstart Interface File

A hotstart file (sometimes called a spin-up file or a restart file) is a binary file created by the software that contains hydraulic and water quality variables for the network system at the end of a simulation run. The data contained in this file consists of the water depth and concentration of each pollutant at each node of the system, as well as the flow rate and concentration of each pollutant in each link. The hotstart file saved after a simulation run can be used to define the initial conditions for a second, subsequent run.

Hotstart files can be used to avoid the initial numerical instabilities that sometimes occur when performing hydrodynamic routing. For this purpose, a hotstart file is typically generated by imposing a constant set of base flows (for a natural channel network) or set of dry weather sanitary flows (for a sewer network) over some startup period of time. The resulting hotstart file from this run is then used to initialize a subsequent simulation run where the inflows of real interest are imposed.

It is also possible to both use and save a hotstart file in a single run, starting off the run with one file and saving the ending results to another. The resulting file can then serve as the initial conditions for a subsequent run, if desired. This technique can also be used to divide up extremely long continuous simulations into more manageable pieces.

Aside from using the Analysis Options dialog box to define a hotstart file, you can also save the results of the current simulation to a hotstart file by selecting **FILE > EXPORT > HOTSTART FILE**.

Routing Interface File

A routing interface file stores time series of flows and pollutant concentrations that are discharged from the outfall nodes of network system model. This file can serve as the source of inflow to another network system model that is connected at the outfalls of the first model. This allows very large networks to be broken into smaller sub-networks that can be analyzed separately, allowing a downstream network to read the upstream network's routing interface file.

However, when a larger dendritic model is broken into several smaller models, it becomes necessary to combine multiple input routing interface files together from the upstream models into a single interface file in order to continue modeling downstream. This is because the software only accepts a single routing interface file as input. Multiple routing interface files can be combined using the Combine Routing Interface Files dialog box, as described in the following section titled *Combining Routing Interface Files*.

Storm Selection

The Storm Selection tabbed pane of the Analysis Options dialog box is used to define the storm or multiple storms to be analyzed. Note that if the **Hydrology Runoff** computational option in the General tabbed pane is unchecked, then the Storm Selection tabbed pane will be unavailable.

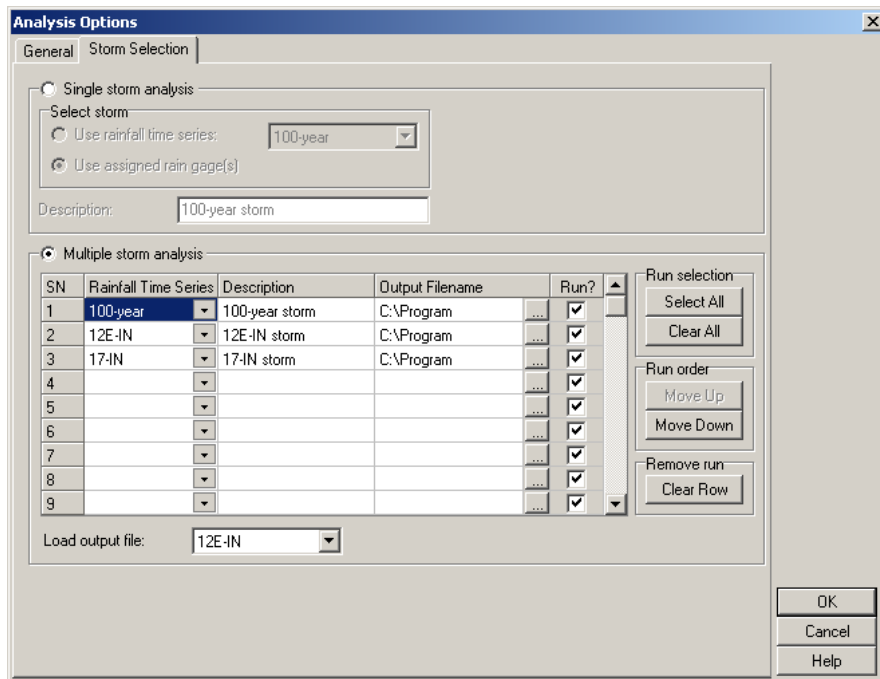

Figure 4.4 The Analysis Options dialog box, Storm Selection tabbed pane

The following options are provided for defining the storm or multiple storms to be analyzed.

Single Storm Analysis

This section of the Storm Selection tabbed pane is used to define a single storm to be analyzed for the defined model. Note, however, that this section changes based upon the hydrology method selected as detailed below.

Rational, Modified Rational, DeKalb Rational Hydrology Methods

When using the Rational, Modified Rational, or DeKalb Rational hydrology methods, then the Single Storm Analysis section changes as shown in the following figure.

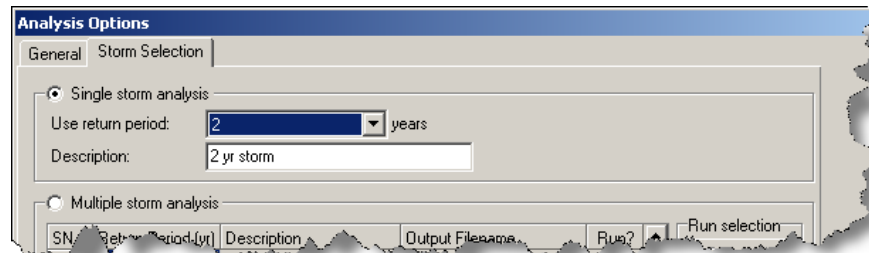

Figure 4.5 The Single Storm Analysis section when using the Rational, Modified Rational, or DeKalb Rational hydrology methods

The following parameters are used to define the single storm to be analyzed.

Use Return Period

From the drop-down list, select the storm return period (in years) to retrieve a corresponding storm intensity for. This drop-down list is unavailable (grayed out) when using the **INTENSITY DIRECT ENTRY** rainfall equation in the IDF Curves dialog box. See the section titled *IDF Curves* on page 398 for more information on defining the intensity duration frequency data for a design storm.

Description

Enter a single line description defining the storm being analyzed. This description will be included in the analysis output.

All Other Hydrology Methods

When using any of the other hydrology methods available, then the Single Storm Analysis section changes as shown in the following figure.

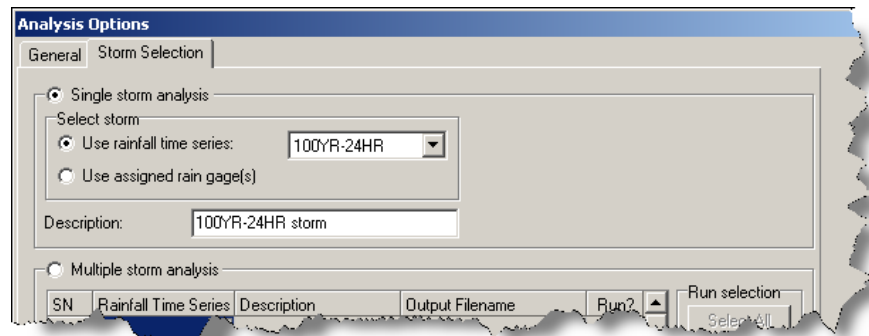

Figure 4.6 The Single Storm Analysis section when using any of the other hydrology methods available

The following parameters are used to define the single storm to be analyzed.

Use Rainfall Time Series

Use this option to select a rainfall time series from the drop-down list to assign to the model. This rainfall time series will be applied to all of the subbasins within the model. See the section titled *Time Series* on page 467 for more information on defining the rainfall time series data for a design storm.

The assigned rainfall time series will override any rain gages that have already been assigned to the subbasins.

Use Assigned Rain Gage(s)

Use this option to analyze the model using the rain gage(s) that have already been assigned to the subbasins. This option allows multiple rain gages to be assigned to a model. See the section titled *Rain Gages* on page 388 for more information on defining rain gages.

Description

Enter a single line description defining the storm being analyzed. This description will be included in the analysis output.

Multiple Storm Analysis

This section of the Storm Selection tabbed pane is used to define multiple storms to be analyzed for the defined model. Note, however, that this section changes based upon the hydrology method selected as detailed below.

Rational, Modified Rational, DeKalb Rational Hydrology Methods

When using the Rational, Modified Rational, or DeKalb Rational hydrology methods, then the Multiple Storm Analysis section changes as shown in the following figure.

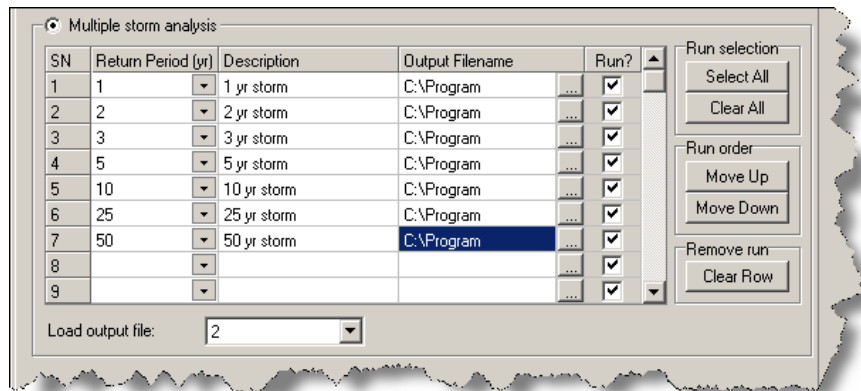

Figure 4.7 The Multiple Storm Analysis section when using the Rational, Modified Rational, or DeKalb Rational hydrology methods

All Other Hydrology Methods

When using any of the other hydrology methods available, then the Multiple Storm Analysis section changes as shown in the following figure.

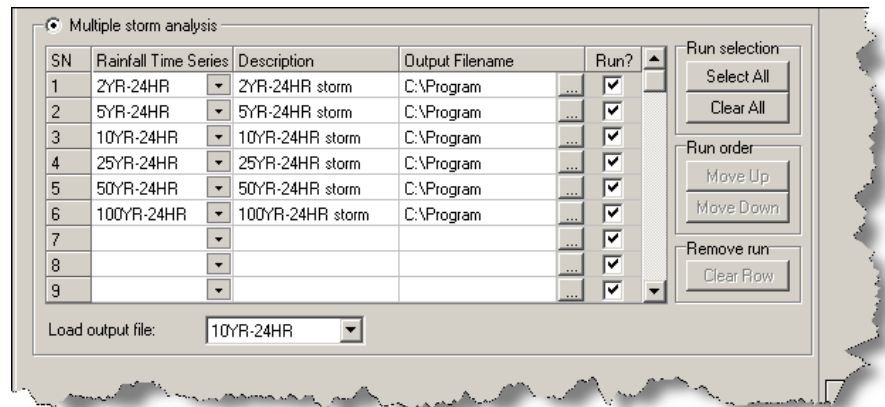

Figure 4.8 The Multiple Storm Analysis section when using any of the other hydrology methods available

Multiple Storm Input Parameters

The following input parameters are used to define multiple storms to be analyzed.

Return Period

When using the Rational, Modified Rational, or DeKalb Rational hydrology methods, this drop-down list allows you to select the storm return period (in years) to have the software retrieve a corresponding storm intensity for. See the section titled *IDF Curves* on page 398 for more information on defining the intensity duration frequency data for a design storm.

Rainfall Time Series

When using any of the other hydrology methods available, this drop-down list allows you to select a rainfall time series to assign corresponding to the storm to be simulated. This rainfall time series will be applied to all of the subbasins within the model. See the section titled *Time Series* on page 467 for more information on defining the rainfall time series data for a design storm.

The assigned rainfall time series will override any rain gages that have already been assigned to the subbasins.

Description

Enter a single line description defining the storm being analyzed. This description will be included in the analysis output.

Output Filename

This entry allows you to define the subdirectory and filename where the analysis solution file is to be written to. Click the (...) browse button to interactively navigate to the directory for saving this file.

Run?

This check box allows you to interactively select which defined storms should be analyzed.

Load Output File

This drop-down list allows you to select which one of the specified multiple storms should have the analysis results loaded after the analysis is complete. This allows you to then review the results from that storm. This drop-down list will only show those storms that have been defined to be analyzed.

If you do not want any analysis results to be loaded after the analysis is complete, select **NONE** from the drop-down list.

Note that you can manually load the analysis results after an analysis is complete. See the section titled *Loading Previous Analysis Results* on page 108 for more information.

Combining Routing Interface Files

As shown in the following figure, by breaking a large model up into separate smaller models, you can benefit by running the smaller sub-models more quickly since there are fewer elements to consider. In addition, you can review the results more quickly and can calibrate the model to observed flows more easily since there are fewer elements to compare.

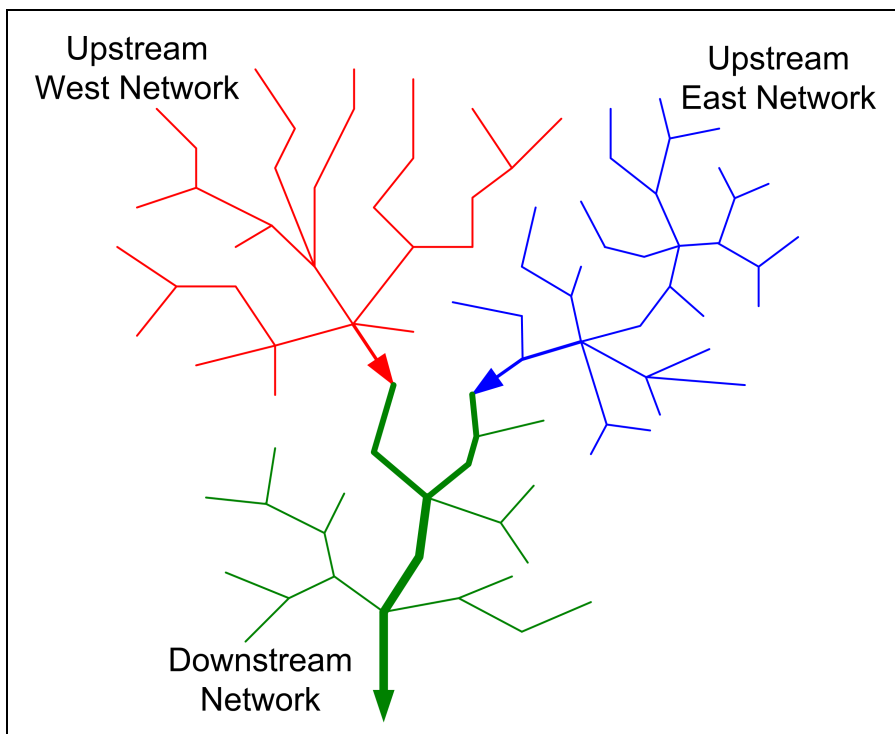

Figure 4.9 A large model broken up into separate smaller models

When analyzing the downstream model, the outflow results from upstream models need to be referenced as external routing interface files. However, when a larger dendritic model is broken into several smaller models, it becomes necessary to combine multiple input routing interface files together from the upstream models into a single interface file in order to continue modeling downstream. This is because the software only accepts a single routing interface file as input.

The Combine Routing Interface Files dialog box, shown in the following figure, is used to combine separate routing interface files together into a single routing

interface file. This combining operation can be performed iteratively if required, when it is required to combine numerous upstream routing interface files into a single interface file. Select **ANALYSIS ► COMBINE ROUTING INTERFACE FILES** to display this dialog box.

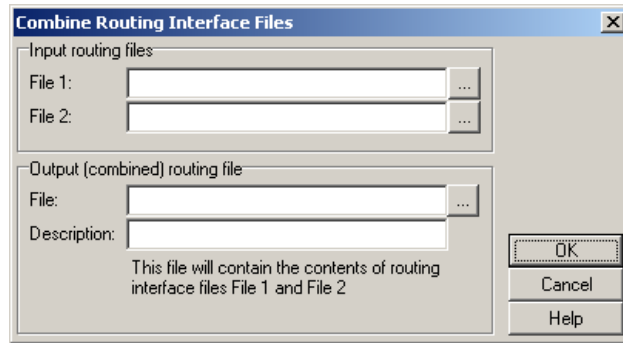

Figure 4.10 The Combine Routing Interface Files dialog box

The following sections are provided for defining the required interface files.

Input Routing Files

This section is used to define the two routing interface files to be combined.

Click the (...) browse button to interactively select the routing interface files.

Output (Combined) Routing File

Specify the resultant routing interface file to be created from combining the two input routing interface files. Click the (...) browse button to interactively navigate to the directory for saving this file. In addition, a description can be defined for the combined interface file.

Clicking OK combines the two input routing interface files into the single output routing interface file.

RDII and Routing File Format

RDII and routing interface files have the same ASCII text format. The file format is detailed here:

Line Number	Description
1	Contains the keyword SWMM5
2	Text that describes the file (must be on one line, can be blank)
3	Time step used for all inflow records (defined in integer seconds)
4	Number of variables stored in the file, where the first variable must always be flow rate
5	Name and units of each variable (one per line), where flow rate is the first variable listed and is always named FLOW
6	Number of nodes with recorded inflow data
7	Name of each node (one per line)
8	Text that provides column headings for the data to follow (can be blank)
9	Each node at each time step, a line with: <ul style="list-style-type: none">■ Node ID■ Date (year, month, and day separated by spaces)■ Time of day (hours, minutes, and seconds separated by spaces)■ Flow rate followed by the concentration of each quality constituent

Time periods with no values at any node can be skipped. An excerpt from an RDII interface file is shown below:

```
SWMM5
Example File
300
1
FLOW CFS
2
N1
N2
Node Year Mon Day Hr Min Sec Flow
N1 2002 04 01 00 20 00 0.000000
N2 2002 04 01 00 20 00 0.002549
N1 2002 04 01 00 25 00 0.000000
```

Figure 4.11 Example RDII interface file

Performing an Analysis

Once you have defined the network model, you are ready to perform an analysis.

Select **ANALYSIS ► PERFORM ANALYSIS** or click the **PERFORM ANALYSIS**  icon from the Standard toolbar. Before the software begins the simulation, the built-in Model Checker reviews the defined input data for any omissions or potential problems with the model data. If it encounters an error with the input data, it will explain what is wrong and how you can correct it. The Model Checker can be thought of as an expert modeler, pointing out any errors contained within the model.

If the software cannot find anything wrong with the defined model, it starts the model simulation and displays Perform Analysis dialog box, as shown in the following figure. As the analysis runs, its current status is reported.

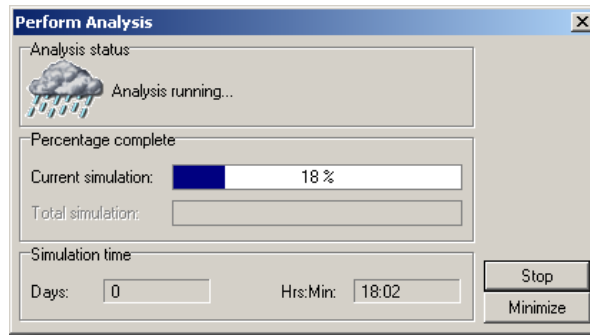

Figure 4.12 The Perform Analysis dialog box shows the status of the model simulation

To stop the model run before it completes the simulation, click the Stop button or press the Esc key. Analysis results up until the time when the simulation was stopped will be available for viewing. To minimize the software while the analysis is running, click the Minimize button in the Perform Analysis dialog box.

If the model fails to run to completion, the Perform Analysis dialog box will indicate that the analysis was unsuccessful and will direct you to the ASCII Output Report for more details. For further information on troubleshooting an analysis, see the section titled *Troubleshooting a Model* on page 85.

Once the analysis has completed, the software will display that the analysis was successful, as shown in the following figure.

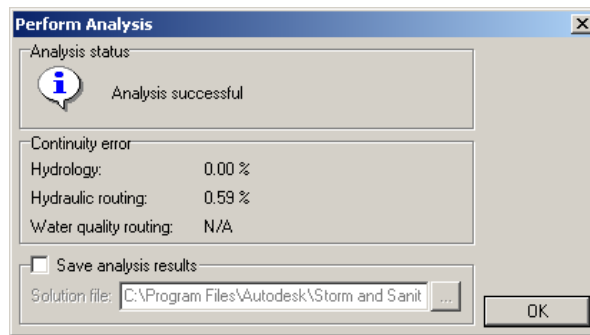

Figure 4.13 The software will report that the analysis was successful

In addition, the **RUN STATUS** section of the status bar, as shown in the following figure, will display **RESULTS COMPLETE** to indicate that the analysis ran successfully and the solution results are available for review.

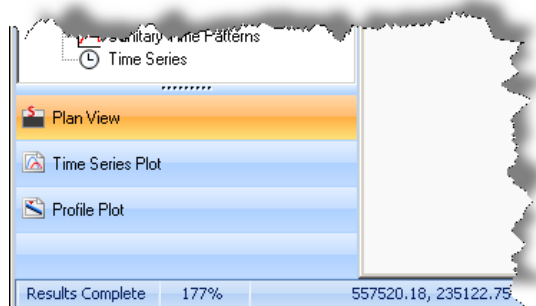

Figure 4.14 The status bar will show **RESULTS COMPLETE** to indicate that the analysis results are available

If you modify the model after a successful run has been made, the status bar will change to **RESULTS DIFFER** indicating that current computed results no longer apply to the modified model. If the status bar shows **NO RESULTS**, then analysis results are not available and you need to run the analysis to get the analysis results.

Saving Analysis Results

When performing a single storm analysis, the Perform Analysis dialog box provides an option to save the simulation results so that they can be reviewed at a later time. This prevents you from having to re-run the simulation each time you want to review the model results—and is especially important for large models since it can take a long time to run the simulation. To save the simulation results to an external file after the simulation has completed, check the **SAVE ANALYSIS RESULTS** option at the bottom of the Perform Analysis dialog box.

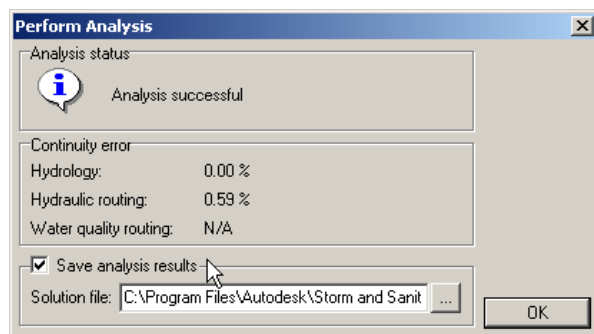

Figure 4.15 The Perform Analysis dialog box provides you with an option to save the simulation results so that they can be reviewed at a later time

The software will suggest a default solution filename containing the filename of the original input file in addition to the date and time stamp of the simulation run. The date stamp is in the form of **YYYY MM DD** and the time stamp is in the form of **HHMMSS**. The file extension is **.SOL**. However, the filename can be changed to anything, such as *PreDevelopment.Sol*.

The solution file will be saved in the same directory as the input file is stored in. However, you can click the (...) browse button and select any directory in order to save the solution file to.

To re-load a previously run simulation solution file, see the section titled *Loading Previous Analysis Results* on page 108.

Multiple Storm Analysis

If a multiple storm analysis is being performed, then the analysis solution files are always saved. For more information on multiple storm analysis, see the section titled *Multiple Storm Analysis* on page 78.

Water Quality Routing

Water quality routing within channel and pipe links assume that the conduit link behaves as a continuously stirred tank reactor (CSTR). Although a plug flow reactor assumption might be more realistic, the differences will be small if the travel time through the conduit link is on the same order as the routing time step. The concentration of a constituent exiting the conduit at the end of a time step is found by integrating the conservation of mass equation, using average values for quantities that might change over the time step such as flow rate and conduit link volume.

Water quality modeling within detention ponds follows the same approach used for conduit links. For other types of nodes that have no storage volume (i.e., junctions, inlets, and flow diversions), the quality of water exiting the node is simply the mixture concentration of all water entering the node.

Troubleshooting a Model

If the model fails to run to completion, as shown in the following figure, the Perform Analysis dialog box will indicate that the analysis was unsuccessful and direct you to the ASCII Output Report for more details.

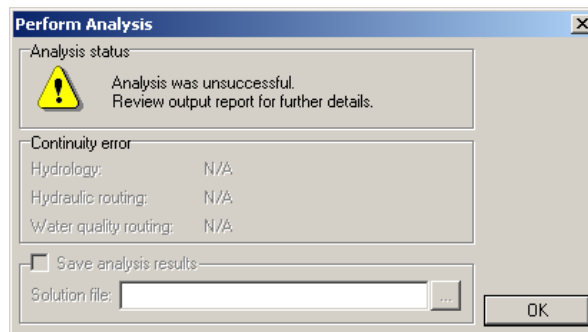

Figure 4.16 If the model fails to run, the software will report this and direct you to the ASCII Output Report for more details

After clicking OK at the Perform Analysis dialog box, the software will display the ASCII Output Report, as shown in the following figure. This report will provide details of why the analysis failed.

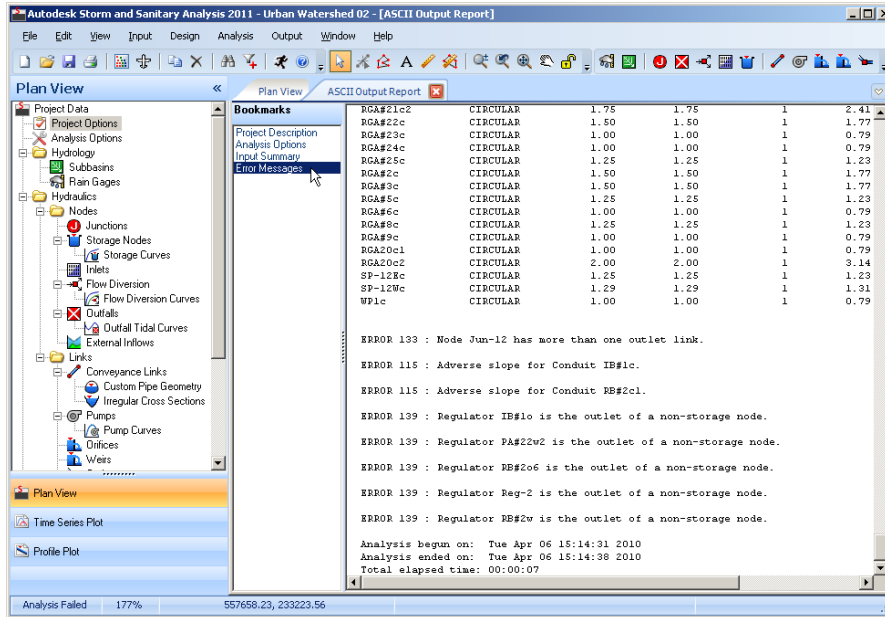

Figure 4.17 The ASCII Output Report provides details of why the model analysis failed

The ASCII Output Report will include an error statement, code, and description of the problem that it encountered. For example:

ERROR 138: Node JUN-32 has initial depth greater than maximum depth

Refer to the following section titled *Analysis Warning and Error Messages* for a detailed description of all analysis error messages.

The following are the most common problems that are encountered when an analysis ends prematurely or the analysis results appear questionable.

Unknown ID Errors

These errors typically appear when an element references another element that was not defined. An example would be a subbasin whose outlet was defined as JUN-29, but no such subbasin or node with that ID exists. Similar situations can exist for incorrect references made for curves, time series, time patterns, aquifers, snow packs, irregular cross sections, pollutants, and land uses.

File Errors

These errors occur when:

- A file cannot be located.
- A file being referenced as an external input file has the wrong format.
- A file being written to cannot be opened. For example, you may not have write permissions for the subdirectory (or folder) where the file is to be stored.

Network Layout Errors

A valid stormwater or wastewater network must obey the following conditions, and the software will display an error message if any of these conditions are not met:

- An outfall node can have only one link connected to it.
- A flow diversion must have exactly two outflow links attached to it.
- When performing Kinematic Wave flow routing, a junction can only have one outflow link. In addition, orifices, weirs, and outlets can only be used as outflow links from storage nodes.
- When performing Hydrodynamic flow routing, at least one outfall node must be defined in the network.

Continuity Errors

When an analysis completes successfully, the mass continuity errors for runoff, flow routing, and water quality routing will be displayed in the Perform Analysis dialog box as shown in the following figure. These errors represent the percent difference between initial storage plus total inflow and final storage plus total outflow for the entire network model. If these continuity errors exceed some reasonable level, such as 10 percent, then the validity of the analysis results should be reviewed.

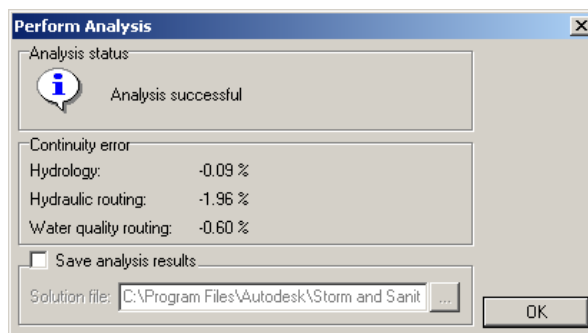

Figure 4.18 The Perform Analysis dialog box provides a summary listing of the mass continuity errors for runoff, flow routing, and water quality routing

The most common reasons for excessive continuity errors are:

- Computational time steps are too large.
- Conduits are too short.

Unstable Flow Routing Errors

Due to the explicit construction of the numerical methods used for Dynamic and Kinematic Wave routing, the flows in some links or water depths at some nodes may fluctuate or oscillate significantly for short periods during the simulation as a result of numerical instabilities in the solution scheme.

As shown in the following figure, the ASCII Output Report contains a section titled **HIGHEST CONTINUITY ERRORS** which lists those nodes in the network that have the largest continuity errors. If the continuity error for a node appears to be excessive, then consider whether the node is of importance to the network. If it is, then further review is recommended to determine how this error can be reduced.

```

*****
Highest Continuity Errors
*****
Node JUAC01 (-29.08%)
Node Jun-32 (13.64%)
Node Jun-31 (-6.42%)
Node Jun-30 (-5.51%)
Node JMeijerParking04 (1.49%)

*****
Time-Step Critical Elements
*****
Link Con-40 (29.89%)
Link Con-46 (13.20%)

*****
Highest Flow Instability Indexes
*****
Link Con-14 (61)
Link Con-48 (12)
Link LiftStation01 (12)
Link Con-39 (5)
Link Con-41 (5)

```

Figure 4.19 The ASCII Output Report provides details of the model continuity check

Also contained in the ASCII Output Report (see Figure 4.19) is a section titled **TIME-STEP CRITICAL ELEMENTS**. This section lists those links that may be too short for the time step defined in the Analysis Options dialog box (see page 69). Basically, the length of a link must be long enough to allow the flow to enter the link without leaving the link within a single time step. If the flow enters and leaves the link within a single time step, then the model cannot accurately account for changes in the flow being routed through the link. Note that either the **ROUTING TIME STEP** can be shortened (see page 70) or a **LENGTHENING TIME STEP** can be defined (see page 73).

Further contained in the ASCII Output Report (see Figure 4.19) is a section titled **HIGHEST FLOW INSTABILITY INDEXES**. This section lists those links that have a Flow Instability Index (FII) that shows a flow value that was higher (or lower) than the flow in both the previous and subsequent time steps. This index is normalized with respect to the expected number of such turns that would occur for a purely random series of values, and can range from 0 to 150. The links with the five highest FII values is listed in this section.

As an example of how the Flow Instability Index can be used, consider the flow hydrograph shown in the following figure. The solid line plots the flow hydrograph for the link identified as having the highest FII value (100) in a hydrodynamic flow routing run that used a fixed time step of 30 seconds. The dashed line shows the hydrograph that results when a variable time step was used instead, which is now completely stable.

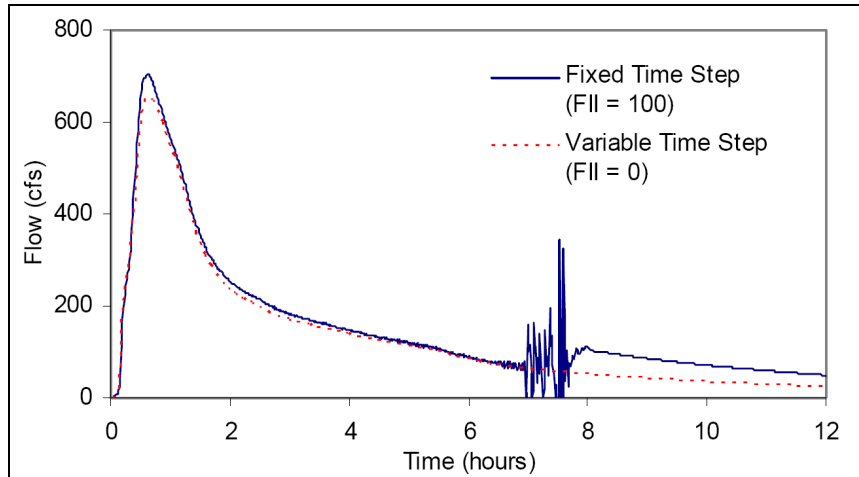

Figure 4.20 An flow hydrograph plot of a link that is unstable when using a fixed time step of 30 seconds and the same link that is stable when using a variable time step

Flow time series plots for the links having the highest FII's should be inspected to insure that flow routing results are acceptably stable. Selecting those elements with the highest FII and then plotting a hydrograph plot of these elements can be performed for this check. In addition, hydrograph plots comparing a link's flow and the corresponding water depth at its upstream node can also help when reviewing the model stability.

Since numerical instabilities generally occur over short time periods, they may not be visible with hydrograph plots when using long reporting time steps. To assist in detecting such instabilities, it is suggested that a reporting time step of 1 minute (or less) be used—at least during the initial review of the analysis results.

Numerical instabilities can be reduced by performing the following:

- Reducing the routing time step
- Using the variable time step option with a smaller time step factor
- Selecting to ignore the inertial terms of the momentum equation
- Selecting the option to numerically lengthen short conduits

Analysis Warning and Error Messages

This section lists possible warning and error messages that the software will report in the ASCII Output Report. Warning messages are generated if the software detects that there is a potential problem with the defined model. Error messages are generated if the analysis fails to run to completion.

Warning Messages

WARNING 001: Runoff (wet weather) computational time step was reduced to match the recording interval for Rain Gage *nnn*.

The wet weather runoff computational time step recording interval was automatically reduced to the smallest time interval in the rain gage time series so that no rainfall data was missed during the simulation.

WARNING 002: Max/rim elevation (depth) increased to account for connecting conduit height dimensions for Node *nnn*.

The maximum depth for the node was automatically increased to match the top (or crown) of the highest connecting conduit.

WARNING 003: Inlet (or Outlet) invert elevation defined for Conduit *nnn* is below upstream (or downstream) node invert elevation. Assumed conduit inlet (or outlet) invert elevation equal to upstream (or downstream) node invert elevation.

The connecting link invert elevation (or offset) was below the connecting node's invert. Therefore, the invert elevation was changed to match that of the connecting node.

WARNING 004: Minimum elevation drop used for Conduit *nnn*.

The elevation drop between the end nodes of the conduit was less than 0.001 ft (or 0.00035 m). Therefore, the minimum elevation drop value (i.e., 0.001 ft) was used to calculate the conduit slope.

WARNING 005: Minimum slope used for Conduit *nnn*.

The conduit's computed slope was below the user-specified Minimum Conduit Slope so the latter value was used instead.

WARNING 006: Dry weather runoff computational time step increased to match the wet weather runoff computational time step.

The user-specified time step for computing runoff during dry weather periods was lower than that defined for wet weather periods and was automatically increased to match the wet weather value.

WARNING 007: Routing computational time step reduced to match the runoff (wet weather) computational time step.

The user-specified time step for flow routing was larger than the wet weather runoff time step and was automatically reduced to match the runoff time step to prevent loss of accuracy.

WARNING 008: Elevation drop exceeds length for Conduit *nnn*.

The elevation drop across the ends of a conduit should not be greater than the conduit's length. Check for errors in the length and in both the invert elevations and offsets at the conduit's upstream and downstream nodes.

WARNING 009: Time series interval greater than recording interval for Rain Gage.

The rainfall time series interval should be less than or equal to the specified recording interval for the defined rain gage.

WARNING 101: Storage Node *nnn* did not have a maximum depth defined to account for the storage of water. The maximum depth defined for the corresponding storage curve was used.

This **MAXIMUM DEPTH/MAXIMUM ELEVATION** data entry in the Storage Nodes dialog box defines the maximum elevation (or depth) of the storage node (ft or m). If a storage curve is defined, then this value should correspond to the maximum depth specified. If defining a storage vault, then the **MAXIMUM DEPTH/MAXIMUM ELEVATION** value represents the roof of the vault and the entry **Ponded Area** should be specified as 0.0. If defining a free surface storage element that can flood, such as a detention pond, then the **MAXIMUM DEPTH/MAXIMUM ELEVATION** value should be specified as the rim elevation of the detention pond and the entry **PONDED AREA** should be specified as to represent the area that can flood.

WARNING 102: Storage Node *nnn* did not have a maximum elevation defined to account for the storage of water. The maximum depth defined for the corresponding storage curve was used.

Same as above, but using elevation data rather than depth (offset) data.

WARNING 103: Storage Node *nnn* should have a maximum depth defined to account for the storage of water.

If a storage curve was not used to define the storage node volume, then the software is unable to “guess” at how deep the storage node will be when using **FUNCTION** type of storage definition. Regardless, a **MAXIMUM DEPTH/ MAXIMUM ELEVATION** should be defined for the storage node.

WARNING 104: Storage Node *nnn* should have a maximum elevation defined to account for the storage of water.

Same as above, but using elevation data rather than depth (offset) data.

WARNING 105: Possible invalid parameter(s) specified for Papadakis-Kazan for Subbasin *nnn*, please check.

Note that the Papadakis-Kazan parameters are extremely sensitive. The specified values appear to be incorrect.

WARNING 106: Max/rim elevation defined for Junction *nnn* is below junction invert elevation. Assumed max/rim elevation equal to invert elevation.

Elevation of the junction manhole rim (or height of the junction above the junction invert) in ft or m. The rim cannot be below the invert of the junction.

WARNING 107: Initial water surface elevation defined for Junction *nnn* is below junction invert elevation. Assumed initial water surface elevation equal to invert elevation.

Elevation of the water in the junction (or depth of water above the junction invert) at the start of the simulation in ft or m.

WARNING 108: Surchage elevation defined for Junction *nnn* is below junction maximum elevation. Assumed surcharge elevation equal to maximum elevation.

Elevation value (or depth above the junction invert) where pressurized flow is considered to occur (ft or m). This value can be used to simulate bolted (sealed) manhole covers and force main connections. Note that if the manhole is to be allowed to flood when it overflows, then the node cannot become pressurized and this value should be set equal to the junction invert or set to a very high elevation to allow flooding to occur.

WARNING 109: Maximum elevation defined for Storage Node *nnn* is below storage node invert elevation. Assumed maximum elevation equal to invert elevation.

This entry defines the maximum elevation (or depth) of the storage node (ft or m). If a storage curve is defined, then this value should correspond to the maximum depth specified.

If defining a storage vault, then this value represents the roof of the vault and the entry **PONDED AREA** should be specified as 0.0. If defining a free surface storage element that can flood, such as a detention pond, then this value should be specified as the rim elevation of the detention pond and the entry **PONDED AREA** should be specified as to represent the area that can flood.

WARNING 110: Initial water surface elevation defined for Storage Node *nnn* is below storage node invert elevation. Assumed initial water surface elevation equal to invert elevation.

Elevation of the water in the storage node (or depth of water above the storage node invert) at the start of the simulation (ft or m).

WARNING 111: Maximum elevation defined for Flow Diversion *nnn* is below flow diversion invert elevation. Assumed maximum elevation equal to invert elevation.

Elevation of the flow diversion structure manhole rim (or height of the flow diversion structure above the flow diversion structure invert) in ft or m.

WARNING 112: Initial water surface elevation defined for Flow Diversion *nnn* is below flow diversion invert elevation. Assumed initial water surface elevation equal to invert elevation.

Elevation of the water in the flow diversion structure (or depth of water above the flow diversion structure invert) at the start of the simulation in ft or m.

WARNING 113: Surge elevation defined for Flow Diversion *nnn* is below flow diversion maximum elevation. Assumed surge elevation equal to maximum elevation.

Elevation value (or depth above the flow diversion structure invert) where pressurized flow is considered to occur (ft or m). This value can be used to simulate bolted (sealed) manhole covers and force main connections. Note that if the flow diversion structure is to be allowed to flood when it overflows, then the node cannot become pressurized and this value should be set equal to the flow diversion structure invert or set to a very high elevation to allow flooding to occur.

WARNING 114: Weir crest elevation defined for Flow Diversion *nnn* is below flow diversion invert elevation. Assumed flow diversion weir crest elevation equal to flow diversion invert elevation.

Elevation of the weir crest (or height of the weir crest above the inlet node invert) in ft or m.

WARNING 115: Fixed water surface elevation defined for Outfall *nnn* is below outfall invert elevation. Assumed fixed water surface elevation equal to outfall invert elevation.

This value denotes the water surface elevation (or height of the water above the outfall invert) when a **FIXED** outfall structure has been selected, in ft or m.

WARNING 116: Conduit inlet invert elevation defined for Conduit *nnn* is below upstream node invert elevation. Assumed conduit inlet invert elevation equal to upstream node invert elevation.

Inlet invert elevation defined for Conduit *nnn* is below upstream node invert elevation. Assumed inlet invert elevation.

WARNING 117: Conduit outlet invert elevation defined for Conduit *nnn* is below downstream node invert elevation. Assumed conduit outlet invert elevation equal to downstream node invert elevation.

Same a previous warning message.

WARNING 118: Orifice crest elevation defined for Orifice *nnn* is below upstream node invert elevation. Assumed orifice crest elevation equal to upstream node invert elevation.

Elevation of the orifice crest bottom (or height of the orifice crest bottom above the inlet node invert) in ft or m.

WARNING 119: Weir crest invert elevation defined for Weir *nnn* is below upstream node invert elevation. Assumed weir crest invert elevation equal to upstream node invert elevation.

Elevation of the weir crest (or height of the weir crest bottom above the inlet node invert) in ft or m.

WARNING 120: Maximum depth defined for Junction *nnn* is negative. Assumed zero.

Elevation of the junction manhole rim (or height of the junction above the junction invert) in ft or m.

WARNING 121: Initial depth defined for Junction *nnn* is negative. Assumed zero.

Elevation of the water in the junction (or depth of water above the junction invert) at the start of the simulation in ft or m.

WARNING 122: Surge depth defined for Junction *nnn* is negative. Assumed zero.

Elevation value (or depth above the junction invert) where pressurized flow is considered to occur (ft or m). This value can be used to simulate bolted (sealed) manhole covers and force main connections. Note that if the manhole is to be allowed to flood when it overflows, then the node cannot become pressurized and this value should be set equal to the junction invert or set to a very high elevation to allow flooding to occur.

WARNING 123: Maximum depth defined for Storage Node *nnn* is negative. Assumed zero.

This **MAXIMUM DEPTH/MAXIMUM ELEVATION** data entry in the Storage Nodes dialog box defines the maximum elevation (or depth) of the storage node (ft or m). If a storage curve is defined, then this value should correspond to the maximum depth specified. If defining a storage vault, then the **MAXIMUM DEPTH/MAXIMUM ELEVATION** value represents the roof of the vault and the entry **Ponded Area** should be specified as 0.0. If defining a free surface storage element that can flood, such as a detention pond, then the **MAXIMUM DEPTH/MAXIMUM ELEVATION** value should be specified as the rim elevation of the detention pond and the entry **PONDED AREA** should be specified as to represent the area that can flood.

WARNING 124: Initial depth defined for Storage Node *nnn* is negative. Assumed zero.

Elevation of the water in the storage node (or depth of water above the storage node invert) at the start of the simulation (ft or m).

WARNING 125: Maximum depth defined for Flow Diversion *nnn* is negative. Assumed zero.

Elevation of the flow diversion structure manhole rim (or height of the flow diversion structure above the flow diversion structure invert) in ft or m.

WARNING 126: Initial depth defined for Flow Diversion *nnn* is negative. Assumed zero.

Elevation of the water in the flow diversion structure (or depth of water above the flow diversion structure invert) at the start of the simulation in ft or m.

WARNING 127: Surge depth defined for Flow Diversion *nnn* is negative. Assumed zero.

Elevation value (or depth above the flow diversion structure invert) where pressurized flow is considered to occur (ft or m). This value can be used to simulate bolted (sealed) manhole covers and force main connections. Note that if the flow diversion structure is to be allowed to flood when it overflows, then the node cannot become pressurized and this value should be set equal to the flow diversion structure invert or set to a very high elevation to allow flooding to occur.

WARNING 128: Weir depth defined for Flow Diversion *nnn* is negative. Assumed zero.

Elevation of the weir crest (or height of the weir crest above the inlet node invert) in ft or m.

WARNING 129: Water depth defined for Outfall *nnn* is negative. Assumed zero.

This value denotes the water surface elevation (or height of the water above the outfall invert) when a **FIXED** outfall structure has been selected, in ft or m.

WARNING 130: Inlet invert offset defined for Conduit *nnn* is negative. Assumed zero.

Elevation of the channel or pipe link inlet invert (or height of the channel or pipe link invert above the inlet node invert) in ft or m.

WARNING 131: Outlet invert offset defined for Conduit *nnn* is negative. Assumed zero.

Elevation of the channel or pipe link outlet invert (or height of the channel or pipe link invert above the inlet node invert) in ft or m.

WARNING 132: Crest height defined for Orifice *nnn* is negative. Assumed zero.

Elevation of the orifice crest bottom (or height of the orifice crest bottom above the inlet node invert) in ft or m.

WARNING 133: Crest invert offset defined for Weir *nnn* is negative. Assumed zero.

Same as above, but using depth (offset) data rather than elevation data.

WARNING 134: No curve number assigned to Subbasin *nnn* so assuming curve number 72.

The Subbasins dialog box, Curve Number tab defines the drainage area, land use, and soil property data for computing the composite SCS curve number for the subbasin.

WARNING 135: Outlet upstream invert elevation defined for Outlet *nnn* is below upstream node invert elevation. Assumed outlet upstream invert elevation equal to upstream node invert elevation.

Elevation of the outlet bottom (or height of the outlet bottom above the inlet node invert) in ft or m.

WARNING 136: Height defined for Outlet *nnn* is negative. Assumed zero.

Same as above, but using depth (offset) data rather than elevation data.

WARNING 137: Inlet rim elevation defined for Inlet *nnn* is below catchbasin invert elevation. Assumed inlet rim elevation equal to 1 foot (0.3 m) above catchbasin inlet invert elevation.

Elevation of the storm drain inlet catchbasin rim (or height of the storm drain inlet catchbasin rim above the catchbasin invert) in ft or m.

WARNING 138: Initial water surface elevation defined for Inlet *nnn* is below catchbasin invert elevation. Assumed initial water surface elevation equal to catchbasin inlet invert elevation.

Elevation of the water in the storm drain inlet catchbasin (or depth of water above the catchbasin invert) at the start of the simulation in ft or m.

WARNING 139: Pondered area defined for on sag Inlet *nnn* is zero. Assumed pondered area equal to 10 ft² (0.929 m²).

If the inlet location is defined as located **ON SAG**, then this entry defines the surface area (ft² or m²) occupied by ponded water atop the storm drain inlet once the inlet capacity has been exceeded by the amount of inflow attempting to enter the inlet. If the inlet location is defined as located **ON GRADE**, then this entry is grayed out.

WARNING 140: Inlet *nnn* Manning's roughness coefficient should be greater than 0.0. Assumed a Manning's roughness of 0.013.

This entry specifies an average Manning's roughness coefficient for the roadway. This entry is not used for storm drain inlets on sag.

WARNING 141: Inlet invert elevation defined for downstream Bypass Roadway Link *nnn* is below the storm drain inlet rim elevation. Assumed the downstream bypass roadway link inlet invert elevation equal to the storm drain inlet rim elevation.

The **BYPASS LINK** entry defines the ID of the link that receives any flow that bypasses the storm drain inlet. This link represents the roadway gutter or ditch downstream of the storm drain inlet.

WARNING 142: Outlet invert elevation defined for Upstream Roadway Link *nnn* is below the storm drain inlet rim elevation. Assumed the upstream roadway link outlet invert elevation equal to the storm drain inlet rim elevation. Please verify the "Upstream roadway links" defined for storm drain inlet *nnn*.

The **UPSTREAM ROADWAY LINKS** entry defines the ID's of the links (e.g., channels, pipes, pumps, orifices, weirs, or outlets) that contribute flow to the storm drain inlet. If there are more than one upstream link contributing flow to the storm drain inlet, then the drop-down list will show more than one link. Check those links in the drop-down list that contribute flow to the storm drain inlet.

Error Messages

ERROR 101: Memory allocation error.

There is not enough physical computer memory to analyze the study area.

ERROR 103: Cannot solve Kinematic Wave equations for Link *nnn*.

The internal solver for Kinematic Wave routing failed to converge for the specified link at some stage of the simulation.

ERROR 105: Cannot open Ordinary Differential Equation solver.

The system could not open its Ordinary Differential Equation solver.

ERROR 107: Cannot compute a valid time step.

A valid time step for runoff or flow routing calculations (i.e., a number greater than 0) could not be computed at some stage of the simulation.

ERROR 108: Ambiguous outlet ID name for Subbasin *nnn*.

The name of the element identified as the outlet of a subbasin belongs to both a node and a subbasin in the model.

ERROR 109: Invalid parameter values defined for Aquifer *nnn*.

The properties entered for an aquifer were either invalid numbers or were inconsistent with one another (e.g., the soil field capacity was higher than the porosity).

ERROR 111: Invalid length defined for Conduit *nnn*.

Conduits cannot have zero or negative lengths.

ERROR 113: Invalid roughness defined for Conduit *nnn*.

Conduits cannot have zero or negative roughness values.

ERROR 114: Invalid number of barrels defined for Conduit *nnn*.

Conduits must consist of one or more barrels, with a maximum of 100.

ERROR 115: Adverse (or negative) slope defined for Conduit *nnn*.

For both *Steady Flow* or *Kinematic Wave* routing, all channels, pipes, and culverts must have positive slopes (i.e., the outlet invert must be below the inlet invert). The software will check for this condition when it performs the analysis, and will report this as a problem.

If you have incorrectly defined the inlet and outlet nodes for a link, you can easily correct this. Select the reversed link in the Conveyance Links dialog box and click the Swap button. The software will reverse the direction of the link so that the outlet node becomes the inlet node and the inlet node becomes the outlet node. Alternatively, select the link from the Plan View, right-click to display the context menu, and select Reverse Direction.

However, if a channel, pipe, or culvert does have an adverse slope (i.e., negative slope), where the outlet elevation is higher than the inlet elevation, reversing the direction of the link will not solve this issue. Networks with adverse sloped links can only be analyzed with *Hydrodynamic* routing.

ERROR 116: Invert elevation (or offset) for Conduit *nnn* is below connecting node invert.

Link invert is below the connecting node invert elevation.

ERROR 117: No user-defined irregular cross section defined for Link *nnn*.

There is no user-defined irregular cross section geometry defined for the specified link.

ERROR 119: Invalid cross section data defined for Link *nnn*.

Either an invalid shape or invalid set of dimensions was specified for a link's cross section.

ERROR 121: Missing or invalid pump curve assigned to Pump *nnn*.

Either no pump curve or an invalid type of curve was specified for a pump.

ERROR 131: The following links form cyclic loops in the drainage system.

The *Steady* and *Kinematic Wave* flow routing methods cannot be applied to systems where a cyclic loop exists (i.e., a directed path along a set of links that begins and ends at the same node). The same is true for *Hydrodynamic* routing when water quality analysis is performed.

Most often the cyclic nature of the loop can be eliminated by reversing the direction of one of its links (i.e., switching the inlet and outlet nodes of the link). The names of the links that form the loop will be listed following this message.

ERROR 133: Node *nnn* has more than one outlet link.

Under *Steady* and *Kinematic Wave* flow routing, a junction node can have only a single outlet link.

ERROR 134: Node *nnn* has more than one DIRECT outlet link or DESIGN pump.

Only a single *Direct* conduit or *Design* pump can be directed out of a node; a node with an outgoing *Direct* conduit or *Design* pump cannot have any other outlets and cannot have all of its incoming links be *Direct* conduits and *Design* pumps.

ERROR 135: Flow Diversion *nnn* does not have two outlet links.

Flow diversion nodes must have two outlet links connected to them.

ERROR 136: Flow Diversion *nnn* has invalid diversion link.

The link specified as being the one carrying the diverted flow from a flow diversion node was defined with a different inlet node.

ERROR 137: Weir Diversion *nnn* has invalid parameters specified.

The parameters of a weir-type diversion node either are non-positive numbers or are inconsistent (i.e., the value of the discharge coefficient times the weir height raised to the $3/2$ power must be greater than the minimum flow parameter).

ERROR 138: Node *nnn* cannot have a defined initial WSEL depth greater than node's maximum depth.

A node cannot be in a flooding state at the start of a simulation.

ERROR 139: Regulator *nnn* is the outlet of a non-storage node.

Under *Steady* or *Kinematic Wave* flow routing, orifices, weirs, and outlet links can only be used as outflow links from storage nodes (i.e., detention ponds). Either convert the junction to a storage node or switch to *Hydrodynamic* routing.

ERROR 141: Outfall *nnn* has more than 1 inlet link or an outlet link.

An outfall node (model terminal node) is only allowed to have one link attached to it, and there cannot be a downstream link attached to it. Convert the outfall node to a junction and place a “dummy” outfall node downstream of it, and connect it with a link that will not cause backwater effects.

ERROR 143: Regulator *nnn* has invalid cross section shape.

An orifice must either be circular or rectangular in shape, while a weir must be either rectangular, trapezoidal, or triangular in shape.

ERROR 145: Drainage system has no acceptable outfall nodes.

When performing *Hydrodynamic* flow routing, there must be at least one node designated as an outfall (model terminal node).

ERROR 151: A Unit Hydrograph in set *nnn* has invalid time base.

The time base of a Unit Hydrograph cannot be negative and if positive, must not be less than the recording interval for its rain gage.

ERROR 153: A Unit Hydrograph in set *nnn* has invalid response ratios.

The response ratios for a set of unit hydrographs (the short-, medium-, and long-term response hydrographs) must be between 0 and 1.0 and cannot add up to a value greater than 1.0.

ERROR 155: Invalid RDII sewershed area defined at Node *nnn*.

The sewershed area contributing RDII (Rainfall-Derived Infiltration/Inflow) to a node cannot be a negative number.

ERROR 157: Inconsistent rainfall format for Rain Gage *nnn*.

If two or more rain gages use the same Time Series for their rainfall data then they must all use the same data format (i.e., intensity, volume, or cumulative volume).

ERROR 159: Inconsistent time interval for Rain Gage *nnn*.

The recording time interval specified for the rain gage is greater than the smallest time interval between values in the Time Series used by the gage.

ERROR 161: Cyclic dependency in treatment functions at Node *nnn*.

An example would be where the removal of pollutant 1 is defined as a function of the removal of pollutant 2 while the removal of pollutant 2 is defined as a function of the removal of pollutant 1.

ERROR 171: Curve *nnn* has its data out of sequence.

The X-axis values of a curve must be entered in increasing order.

ERROR 173: Time Series *nnn* has its data out of sequence.

The time (or date/time) values of a time series must be entered in sequential order.

ERROR 181: Invalid Snow Melt Climatology parameters.

The ATI Weight or Negative Melt Ratio parameters are not between 0 and 1 or the site latitude is not between -60 and +60 degrees.

ERROR 182: Invalid parameters defined for Snow Pack *nnn*.

A snow pack's minimum melt coefficient is greater than its maximum coefficient; the fractions of free water capacity or impervious plowable area are not between 0 and 1; or the snow removal fractions sum to more than 1.0.

ERROR 191: Simulation period not properly defined. Select Analysis ► Analysis Options to define the simulation period.

Generally, this error occurs when the time period over which the simulation is to be performed was not defined. Check the simulation starting and ending times, and make certain that they are not the same, and they define a reasonable simulation period.

ERROR 193: Reporting start date cannot come after the simulation ending date.

Self-explanatory.

ERROR 195: Reporting time step should be equal to or a multiple of the routing time step.

The analysis output generated by the software will not correctly represent the model's solution if the reporting time step is not equal to or is a multiple of the routing time step. And, the reporting time step cannot be less than the routing time step.

For example, if the routing time step is 2 minutes (generally routing time steps are less than 1 minute), then a valid reporting time step can be 2, 4, 6 minutes, and so on. However, an invalid reporting time step would be 30 seconds or 3 minutes.

ERROR 196: Reporting time step should be equal to or a multiple of the wet weather time step.

The analysis output generated by the software will not correctly represent the model's solution if the reporting time step is not equal to or is a multiple of the wet weather time step. And, the reporting time step cannot be less than the wet weather time step.

For example, if the wet weather time step is 2 minutes, then a valid reporting time step can be 2, 4, 6 minutes, and so on. However, an invalid reporting time step would be 30 seconds or 3 minutes.

ERROR 200: One or more errors in input file.

This message appears when one or more input file parsing errors (the 200-series errors) occur.

ERROR 201: Too many characters in input line.

A line in the input file cannot exceed 1024 characters.

ERROR 203: Too few items at line *nnn* of input file.

Not enough data items were supplied on a line of the input file.

ERROR 205: Invalid keyword at line *nnn* of input file.

An unrecognized keyword was encountered when parsing a line of the input file.

ERROR 207: Duplicate ID name at line *nnn* of input file.

An ID name used for an element was already assigned to an element of the same category.

ERROR 209: Undefined element *nnn* at line *nnn* of input file.

A reference was made to an element that was never defined. An example would be if node **JUN-123** were designated as the outlet point of a subbasin, yet no such node was ever defined in the network.

ERROR 211: Invalid number *nnn* at line *nnn* of input file.

Either a string value was encountered where a numerical value was expected or an invalid number (e.g., a negative value) was supplied.

ERROR 213: Invalid date/time *nnn* at line *nnn* of input file.

An invalid format for a date or time was encountered. Dates must be entered as month/day/year and times as either decimal hours or as hour:minute:second.

ERROR 217: Control rule clause out of sequence at line *nnn* of input file.

Errors of this nature can occur when the format for writing control rules is not followed correctly. See the section titled *Control Rules* on page 442 for more information.

ERROR 219: Data provided for unidentified irregular cross section at line *nnn* of input file.

A GR line with Station-Elevation data was encountered in the [TRANSECTS] section of the input file after an NC line but before any X1 line that contains the irregular cross section's ID name.

ERROR 221: Irregular cross section station out of sequence at line *nnn* of input file.

The stationing distances specified for the irregular cross section must be in increasing numerical order starting from the leftmost station.

ERROR 223: Irregular Cross Section *nnn* has too few stations.

An irregular cross section must have at least 2 stations defined for it.

ERROR 225: Irregular Cross Section *nnn* has too many stations.

An irregular cross section cannot have more than 1500 stations defined for it.

ERROR 227: Irregular Cross Section *nnn* has no Manning's roughness.

No Manning's roughness was specified for an irregular cross section (i.e., there was no NC line in the [TRANSECTS] section of the input file).

ERROR 229: Irregular Cross Section *nnn* has invalid overbank locations.

The stationing values specified for either the left or right overbank locations of an irregular cross section do not match any of the stationing defined for the irregular cross section's geometry.

ERROR 231: Irregular Cross Section *nnn* has no depth.

All of the stations for an irregular cross section were assigned the same elevation.

ERROR 233: Invalid treatment function expression at line *nnn* of input file.

A treatment function supplied for a pollutant at a specific node is either not a correctly formed mathematical expression or refers to unknown pollutants, process variables, or math functions.

ERROR 301: Files cannot share same names.

The input, report, and binary output files specified on the command line cannot have the same names.

ERROR 303: Cannot open input file.

The input file either does not exist or cannot be opened (e.g., it might be in use by another program).

ERROR 305: Cannot open report file.

The report file cannot be opened (e.g., it might reside in a directory to which you do not have write privileges).

ERROR 307: Cannot open binary results file.

The binary output file cannot be opened (e.g., it might reside in a directory to which you do not have write privileges).

ERROR 309: Error writing to binary results file.

There was an error in trying to write results to the binary output file (e.g., the disk might be full or the file size exceeds the limit imposed by the operating system).

ERROR 311: Error reading from binary results file.

Could not read results saved to the binary output file when writing results to the report file.

ERROR 313: Cannot open scratch rainfall interface file.

Could not open the temporary file used to collate data together from external rainfall files.

ERROR 315: Cannot open rainfall interface file *nnn*.

Could not open the specified rainfall interface file, possibly because it does not exist or because you do not have write privileges to its directory.

ERROR 317: Cannot open rainfall data file *nnn*.

An external rainfall data file could not be opened, most likely because it does not exist or the directory path specified is incorrect.

ERROR 319: Invalid format for rainfall interface file.

Trying to read data from a designated rainfall interface file with the wrong format (i.e., it may have been created for some other project or actually be some other type of file).

ERROR 321: No data in rainfall interface file for Rain Gage *nnn*.

This occurs when a project wants to use a previously saved rainfall interface file, but cannot find any data for one of its rain gages in the interface file.

ERROR 323: Cannot open runoff interface file *nnn*.

A runoff interface file could not be opened, possibly because it does not exist or because you do not have write privileges to its directory.

ERROR 325: Incompatible data found in runoff interface file.

Trying to read data from a designated runoff interface file with the wrong format (i.e., it may have been created for some other project or actually be some other type of file).

ERROR 327: Attempting to read beyond end of runoff interface file.

This error can occur when a previously saved runoff interface file is being used in a simulation with a longer duration than the one that created the interface file.

ERROR 329: Error in reading from runoff interface file.

A format error was encountered while trying to read data from a previously saved runoff interface file.

ERROR 330: Hotstart interface files cannot have same name.

In cases where a run uses one hotstart interface file to start a simulation and another to save results at the end of the simulation, the two files cannot both have the same name.

ERROR 331: Cannot open hotstart interface file *nnn*.

A hotstart interface file could not be opened, possibly because it does not exist or because you do not have write privileges to its directory.

ERROR 333: Incompatible data found in hotstart interface file.

Trying to read data from a designated hotstart interface file with the wrong format (i.e., it may have been created for some other project or actually be some other type of file).

ERROR 335: Error in reading from hotstart interface file.

A format error was encountered while trying to read data from a previously saved hotstart interface file.

ERROR 336: No climate file specified for evaporation and/or wind speed.

This error occurs when evaporation or wind speed data is being read from an external climate file, but no name was supplied for the file.

ERROR 337: Cannot open climate file *nnn*.

An external climate data file could not be opened, most likely because it does not exist.

ERROR 338: Error in reading from climate file *nnn*.

Trying to read data from an external climate file with the wrong format.

ERROR 339: Attempt to read beyond end of climate file *nnn*.

The specified external climate does not include data for the period of time being simulated.

ERROR 341: Cannot open scratch RDII interface file.

Could not open the temporary file it uses to store RDII (Rainfall-Derived Infiltration/Inflow) flow data.

ERROR 343: Cannot open RDII interface file *nnn*.

An RDII (Rainfall-Derived Infiltration/Inflow) interface file could not be opened, possibly because it does not exist or because you do not have write privileges to its directory.

- ERROR 345: Invalid format for RDII interface file.**
Trying to read data from a designated RDII (Rainfall-Derived Infiltration/ Inflow) interface file with the wrong format (i.e., it may have been created for some other project or actually be some other type of file).
- ERROR 351: Cannot open routing interface file *nnn*.**
A routing interface file could not be opened, possibly because it does not exist or because you do not have write privileges to its directory.
- ERROR 353: Invalid format for routing interface file *nnn*.**
Trying to read data from a designated routing interface file with the wrong format (i.e., it may have been created for some other project or actually be some other type of file).
- ERROR 355: Mismatched names in routing interface file *nnn*.**
The names of pollutants found in a designated routing interface file do not match the names used in the current project.
- ERROR 357: Inflows and outflows interface files cannot have same name.**
In cases where an analysis uses one routing interface file to provide inflows for a set of locations and another to save outflow results, the two files cannot both have the same name.
- ERROR 361: Cannot open external file used for Time Series *nnn*.**
The external file used to provide data for the named time series could not be opened, most likely because it does not exist.
- ERROR 363: Invalid data in external file used for Time Series *nnn*.**
The external file used to provide data for the named time series has one or more lines with the wrong format.
- ERROR 401: General system error.**
Unknown error caused the analysis to fail.
- ERROR 402: Cannot open new project while current project still open.**
A new project was attempted to be opened while the current analysis was not yet completed.
- ERROR 403: Project not open or last run not ended.**
Either the data transfer file was unable to be opened, or the previous analysis was not yet completed when a new analysis run was requested.
- ERROR 405: Amount of output produced will exceed maximum file size; either reduce Ending Date or increase Reporting Time Step.**
Amount of output produced will exceed maximum file size; either reduce the **ENDING DATE** or increase the **REPORTING TIME STEP** defined in the Analysis Options dialog box. See the section titled *Analysis Options* on page 69 for more information.
- ERROR 501: Insufficient data in IDF Table for *nnn* year.**
Insufficient Rational Method IDF data was defined. The analysis engine could not compute the correct value for rainfall intensity for the specified storm duration.
- ERROR 502: Summation of sub area percentages of Subbasin *nnn* should be equal to 100% for SCS TR-55 time of concentration method.**
Check the data defined for the SCS TR-55 Time of Concentration in the Subbasins dialog box, for the weighted area method. The percentage of the subbasin areas must total to 100%.

ERROR 503: Cannot use multiple rain gages with the SCS TR-20 hydrology method.

The SCS TR-20 hydrology method only allows one rain gage to be defined.

ERROR 504: Flow Diversion Link *nnn* has an adverse slope.

The **DIVERTED TO** link must not have an adverse (or reverse) slope. It must slope away from the flow diversion structure.

ERROR 505: Invalid storm duration *nnn*.

The defined storm duration is not valid.

ERROR 506: Subbasin *nnn* was not assigned a time of concentration.

When using a hydrology method that requires a time of concentration to be computed, there was insufficient data defined to properly compute a time of concentration value.

ERROR 507: Weighted curve number should be greater than 30 in *nnn* method.

The SCS TR-20 and SCS TR-55 hydrology methods require a curve number greater than 30.

ERROR 509: Elevation for Conduit *nnn* is below connecting node invert.

Link invert is below the connecting node invert elevation.

ERROR 510: Invalid Eagleson TOC channel flow hydraulic radius for Subbasin *nnn*.

The Eagleson TOC channel flow **HYDRAULIC RADIUS** value was invalid.

ERROR 511: Cannot use multiple rain gages with the SCS TR-55 hydrology method.

The SCS TR-55 hydrology method only allows one rain gage to be defined.

ERROR 512: Subbasin *nnn* not assigned a rain gage.

Self explanatory.

ERROR 513: Subbasin *nnn* not assigned to a downstream outlet node or subbasin.

The runoff from the defined subbasin has no where to drain to. Make certain to define the downstream outlet node (or subbasin) it drains to.

ERROR 514: No data defined for Subbasin *nnn* in TR-55 time of concentration section.

Missing the SCS TR-55 time of concentration data for the specified subbasin.

ERROR 515: RDII Unit Hydrograph *nnn* not assigned a rain gage.

When defining rainfall-dependent infiltrations/inflows (commonly abbreviated as RDII), a RDII unit hydrograph is required.

ERROR 517: Error in reading TR-20 project data.

Incomplete SCS TR-20/TR-55 input data defined.

ERROR 518: Subbasin *nnn* time of concentration should be greater than 5 seconds.

The SCS TR-20 and SCS TR-55 hydrology methods require a time of concentration greater than 5 seconds.

ERROR 519: Cannot open file (*nnn*) as the number of convergence trials was exceeded.

Analysis did not converge, no output file present.

ERROR 520: Cannot open file (*nnn*) as file path was invalid.

The directory path to where the log file is to be, is not valid.

ERROR 521: Cannot open log file.

The log file already exists and is locked, the directory path is invalid, or some other file I/O problem was encountered. If this continues to be a problem, then restart the application and/or computer.

ERROR 522: Subbasin *nnn* not assigned to a downstream outlet node.

The runoff from the defined subbasin has no where to drain to. Make certain to define the downstream outlet node it drains to.

ERROR 523: Cannot close the file *nnn* as file handle is invalid. Restart application and/or computer.

File I/O problem was encountered. Restart the application and if that still does not solve the problem, then restart the computer.

ERROR 524: Cannot deallocate memory. Restart application and/or computer.

Memory problem was encountered. Restart the application and if that still does not solve the problem, then restart the computer.

ERROR 525: Ascending / receding limb multiplier must be greater than *nnn*.

The Rational Method ascending limb and/or receding limb multiplier cannot be less than the value specified.

ERROR 526: Subbasin *nnn* area should not be smaller than 0.0064 acres (0.00259 ha.) for SCS TR-20/SCS TR-55 hydrology method.

The TR-20 and TR-55 hydrology methods can model drainage area as small as 0.0064 acres, but not smaller. This is because the analysis engine for the SCS (NRCS) TR-20 and TR-55 hydrology methods internally represent drainage areas in terms of square miles with a 5 decimal digit precision. This corresponds to a drainage area equal to 0.00001 mi² (i.e., 0.00640 acres, 279 ft², or 0.00259 hectares).

ERROR 528: Subbasin *nnn* circular channel diameter must be greater than zero.

When using channelized runoff in the HEC-1 hydrology method, the circular channel must have a diameter defined.

ERROR 529: Subbasin *nnn* trapezoidal channel side slope must be greater than zero.

When using channelized runoff in the HEC-1 hydrology method, the trapezoidal channel side slope cannot be flat.

ERROR 530: Channel Cross Section *nnn* must have eight points to define cross section geometry.

When using channelized runoff in the HEC-1 hydrology method, the channel cross section geometry must have eight points specified.

ERROR 531: Subbasin *nnn* curve number must be greater than 1.0 when using the HEC-1 hydrology method.

There is an error in the HEC-1 data that has been defined. More detail about the error can be found in the HEC-1 output report. Select **OUTPUT | HEC-1 OUTPUT REPORT** to view the report.

ERROR 532: Error in HEC-1 model definition input data. Refer to HEC-1 output report for more information on this error.

There is an error in the HEC-1 data that has been defined. More detail about the error can be found in the HEC-1 output report. Select **OUTPUT | HEC-1 OUTPUT REPORT** to view the report.

ERROR 533: Rain Gage *nnn* should have constant interval rainfall for HEC-1 hydrology method.

HEC-1 hydrology method requires that the specified rainfall data be defined with a uniform time interval.

ERROR 536: Subbasin *nnn* area should not be smaller than 0.064 acres (0.0259 ha.) for HEC-1 hydrology method.

The HEC-1 hydrology method can model drainage area as small as 0.064 acres, but not smaller. This is because the analysis engine for the US Army Corps HEC-1 hydrology method internally represents drainage areas in terms of square miles with a 4 decimal digit precision. This corresponds to a drainage area equal to 0.0001 mi^2 (i.e., 0.0640 acres, 2790 ft^2 , or 0.0259 hectares).

ERROR 537: Unable to perform multiple storm analysis, no storm was selected.

When performing a batch analysis, the storm must be selected for each storm to be analyzed.

ERROR 538: Unable to perform multiple storm analysis, no return period was selected.

When performing a batch analysis, the return period must be selected for each return period to be analyzed.

ERROR 539: Unable to perform multiple storm analysis, *nnn* precipitation time series does not exist.

Unable to retrieve the specified precipitation time series data. When performing a batch analysis, the rainfall time series data must be defined prior to the analysis. The software will not automatically create this data.

ERROR 540: Unable to perform multiple storm analysis, *nnn* return period does not exist.

Unable to retrieve the specified IDF return period data. When performing a batch analysis, the return period data must be defined prior to the analysis. The software will not automatically interpolate the IDF return period data.

ERROR 541: Unable to perform multiple storm analysis, specified output file directory does not exist.

When performing a batch analysis, the output file directory must be created prior to the analysis. The software will not automatically create the file directory.

ERROR 542: Unable to perform multiple storm analysis, unique output file names must be specified for each defined storm simulation.

When performing a batch analysis, the output file name for each storm being analyzed must be unique.

ERROR 543: Unable to perform multiple storm analysis, unique output file names must be specified for each defined return period simulation.

When performing a batch analysis, the output file name for each return period being analyzed must be unique.

ERROR 544: Unable to perform analysis, *nnn* precipitation time series does not exist.

Unable to retrieve the specified precipitation time series data. When performing an analysis, the rainfall time series data must be defined prior to the analysis. The software will not automatically create this data.

ERROR 545: Unable to perform analysis, *nnn* return period does not exist.

Unable to retrieve the specified IDF return period data. When performing an analysis, the return period data must be defined prior to the analysis. The software will not automatically interpolate the IDF return period data.

ERROR 600: On grade Inlet *nnn* does not have two outlet links. At least one stormwater sewer pipe and a bypass gutter link must be defined.

Self explanatory.

ERROR 601: Inlet *nnn* has invalid by-pass link.

The **BYPASS LINK** entry defines the ID of the link that receives any flow that bypasses the storm drain inlet. If the inlet location is defined as located **ON SAG**, then this entry is grayed out since there is no bypass link for sag inlets. The provided drop-down list provides a listing of links (e.g., channels, pipes, pumps, orifices, weirs, or outlets), allowing you to select the bypass link.

ERROR 603: On grade Inlet *nnn* roadway longitudinal slope must be greater than zero.

Cannot have an on-grade storm drain inlet with a flat roadway, since there is no way to then determine the amount of gutter spread at the inlet.

ERROR 604: Median Inlet *nnn* grate width (perpendicular to flow) should not be greater than the channel bottom width.

When defining a storm drain inlet median inlet, the grate width must fit within the channel (gutter) bottom width.

ERROR 605: Inlet *nnn* gutter width should be greater than zero.

Cannot have a storm drain inlet gutter without a width defined.

ERROR 606: Inlet *nnn* grate width should be greater than zero.

Cannot have a storm drain inlet without a grate width defined.

ERROR 607: Inlet *nnn* gutter capture curve is not a valid curve.

The storm drain inlet gutter capture curve is not properly defined.

ERROR 608: Inlet *nnn* maximum cutoff is undefined.

The storm drain inlet maximum cutoff value is not defined.

ERROR 609: Inlet *nnn* channel longitudinal slope must be greater than zero.

Cannot have an on-grade storm drain inlet with a flat median, since there is no way to then determine the amount of spread at the inlet.

ERROR 610: Inlet *nnn* grate length should be greater than zero.

Cannot have a storm drain inlet without a grate length defined.

Display Analysis Results

5

After the network analysis has been performed, you will want to review the analysis results. This chapter describes the different ways in which the analysis results can be displayed and reviewed.

Output Variables

The software can display computed results for the following variables on the Plan View, as well as plot, tabulate, and statistically analyze these variables.

Subbasins

Groundwater Elevation	(ft or m)
Groundwater Flow	Groundwater flow into drainage network (cfs or cms)
Loss Rate	Infiltration + evaporation (in/hr or mm/hr)
Rainfall Rate	(in/hr or mm/hr)
Runoff Flow Rate	(cfs or cms)
Snow Depth	(in or mm)
Water Quality	Washoff concentration or each pollutant (mass/liter)

Nodes

Flooding Flow Rate	Surface flooding (inflows lost from the system when the water depth exceeds the defined maximum node depth, cfs or cms)
Lateral Inflow	Runoff + all other external inflows (cfs or cms)
Total Inflow	Lateral inflow + upstream inflows (cfs or cms)
Volume	Water volume held in storage (including ponded water, ft ³ or m ³)
Water Depth	Water depth above node invert (ft or m)
Water Surface Elevation	(ft or m)
Water Quality	Concentration of each pollutant after treatment (mass/liter)

Links

Average Depth	Average water depth (ft or m)
Capacity Ratio	Ratio of Depth to Full Depth
Flow Rate	(cfs or cms)
Flow Velocity	(ft/sec or m/sec)
Froude Number	
Maximum Depth	Maximum water depth (ft or m)
Water Quality	Concentration of each pollutant (mass/liter)

System

Air Temperature	Degrees (F or C)
Average Loss Rate	Infiltration + evaporation (in/hr or mm/hr)
Direct Inflow	Total direct inflow (cfs or cms)
Dry Weather Inflow	Total dry weather inflow (cfs or cms)
External Inflow	Total external inflow (cfs or cms)
Groundwater Inflow	Total groundwater inflow (cfs or cms)
I & I Inflow	Total RDII inflow and infiltration (cfs or cms)
Nodal Storage Volume	Total nodal storage volume (ft ³ or m ³)
Outfall Outflows	Total outflow from outfalls (cfs or cms)
Rainfall Rate	Total rainfall rate (in/hr or mm/hr)
Runoff Flow	Total runoff flow (cfs or cms)
Snow Depth	Total snow depth (in or mm)
Surface Flooding	Total surface flooding (cfs or cms)

Loading Previous Analysis Results

Large models can take a long time to run their simulation. Therefore, when the simulation is completed, the simulation results should be saved so that they can be reviewed at a later time if desired. This prevents you from having to re-run the simulation each time you want to review the model results. The section titled *Saving Analysis Results* on page 84 describes how to save the simulation results after the analysis has completed.

In order to load the simulation results from a previously performed analysis, select **FILE ► OPEN RESULTS** as shown in the following figure. The Open Results dialog box is then displayed, allowing you to select the analysis output result file to load.

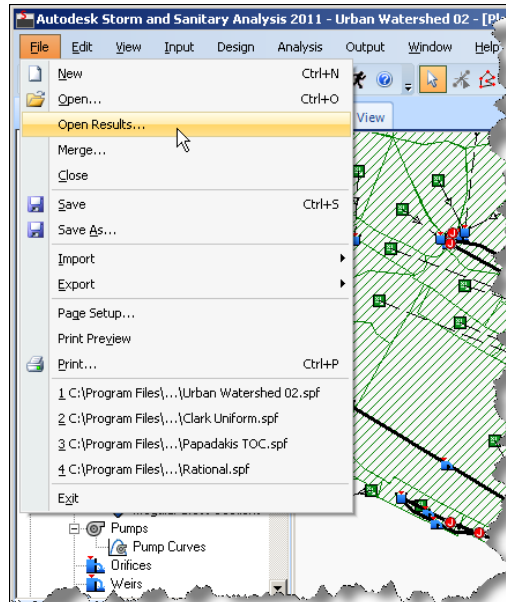

Figure 5.1 Load the simulation results from a previously performed analysis

From the Open Results dialog box you can select the solution file to load. Note that the default solution filename contains the filename of the original input file along with a date and time stamp of the simulation run. The date stamp is in the form of **YYYY MM DD** and the time stamp is in the form of **HHMMSS**. Select the solution file to load and click OK.

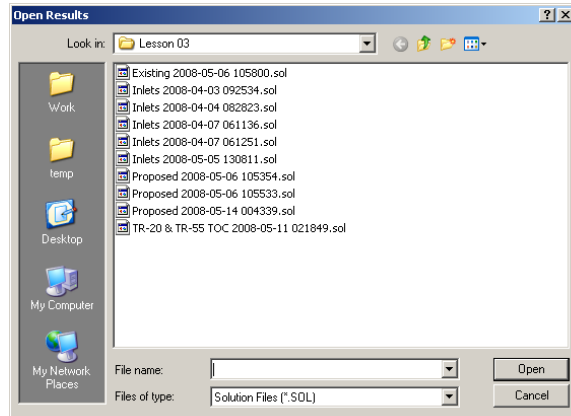

Figure 5.2 Select the solution file to load

Once the solution file is loaded, the output results can be reviewed as if the simulation was just recently performed.

Input Dialog Boxes

The network element input dialog boxes allow you to view the corresponding analysis results. As shown in the following figure, each dialog box contains an Analysis Summary section that summarizes the simulation results for the currently selected element. Then, as you scroll through the list of network elements within the table view, the corresponding simulation results is displayed for the current element.

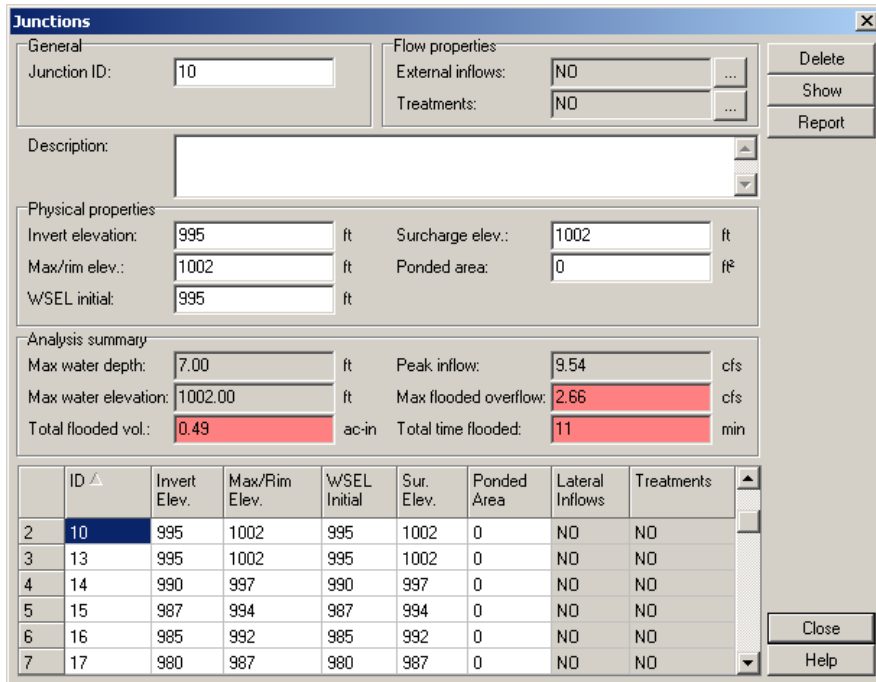

Figure 5.3 The input dialog boxes display a summary of the corresponding simulation results for each element

Note that for link elements that are experiencing surcharging, or node elements that are experiencing flooding, the analysis summary output fields will change the background color to red in order to help you find those elements that should be reviewed for adequacy.

For storm drain inlets, in the Inlet dialog box Analysis Summary section the software assumes that if more than ½ of the roadway lane is covered with stormwater from gutter spread, that the inlet capacity is not sufficient. More information is provided in the section titled *Analysis Summary Results* on page 239.

Output Animation

The Output Animation dialog box, as shown in the following figure, allows you to select the date and time (i.e., time step) for which the simulation results will be displayed for both the Plan View and Profile Plot, as well as animate the results. To display the Output Animation dialog box, select **OUTPUT ► OUTPUT ANIMATION**.

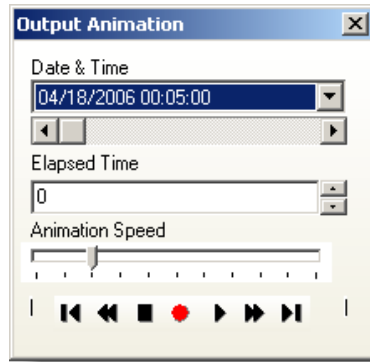

Figure 5.4 The Output Animation dialog box allows you to select the date and time for which the simulation results will be displayed on the Plan View and Profile Plot, as well as animate the results

Note that if there are no analysis results available, the Output Animation menu item will be grayed out. Note that the Output Animation dialog box can be positioned anywhere on the computer screen, to allow you to view and interactively control the animation.

The following controls are available in the Output Animation dialog box.

Date & Time

This control selects the day and hour for which the analysis results will be displayed. The drop-down list can be used to select a specific day and hour, whereas the horizontal slider allows you to step through each hour.

Elapsed Time

This control selects the elapsed time from the start of the simulation for which the analysis results will be displayed. The spin control allows you to step through each time step of the analysis.

Animation Speed

The horizontal slider controls the speed at which the animation is to be played at for the Plan View and Profile Plot (i.e., updating map color-coding and hydraulic grade line profile depths).

To animate the analysis results with time, use the provided buttons to control the animation. For example, clicking the **PLAY** ► button will run the animation forward in time.



Animation Control Keyboard Commands

In addition to animation control buttons, the following keyboard commands are also provided to control the animation. In that way, you can more easily control the playback while viewing the animation.

Space Bar	Pause/Unpause
Ctrl+Shift+F	Speed up (faster)
Ctrl+Shift+D	Slow down (slower)
Ctrl+Shift+N	Next step (must be paused)
Ctrl+Shift+B	Back step (must be paused)

Recording Animations

The Plan View and Profile Plot animations can be recorded to a video file, allowing you to play the animation back without requiring the use of the software. Alternatively, you can embed the videos in a PowerPoint presentation. The animation files can be saved as AVI or WMV (Windows Media) video files. Support for various video compression codecs is included, allowing the saved animation video files to be quite small.

To save an animation, first position the time step slider to where you want to start the recording. The animation should be paused at the time step you want to start recording at. Next, click the **RECORD**  button and the recording and animation will start simultaneously from this time step. Click the **STOP**  button or **RECORD**  button to stop the recording once you have recorded the part of the animation that you wanted. Alternatively, let the animation run to the end of the simulation results. The software then displays a Save Animation dialog box, allowing you to specify the filename and directory in which to save the file.

In order to specify the video file format in which to save the animation, select **OUTPUT ► ANIMATION RECORDING OPTIONS**. The Animation Recording Options dialog box is then displayed, allowing you to select various options for recording of the videos. Note that the animation recording options must be defined prior to saving the video file.

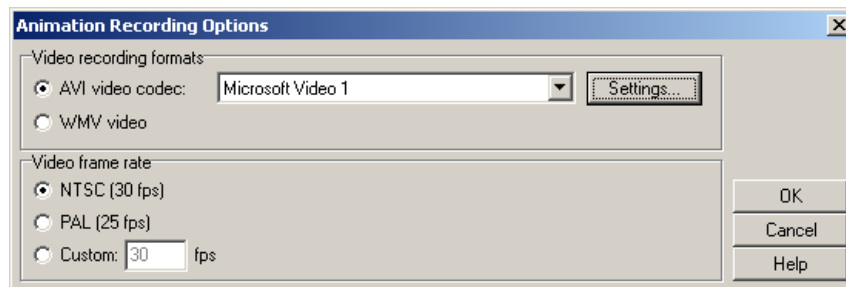

Figure 5.5 The Animation Recording Options dialog box allows you to select the video file format to save animations as

A list of the Animation Recording Options dialog box entries follow, with a short description given for each entry.

Video Recording Formats

This entry is used to specify the video file format to be used to save the animation recording as. The following video recording formats are available:

- AVI** Audio Video Interleave (AVI) is a multimedia container format introduced by Microsoft in 1992 as part of its Video for Windows technology. AVI files can contain both audio and video data in a file container that allows synchronous audio-with-video playback.
- WMV** Windows Media Video (WMV) is a compressed video file format for several proprietary codecs developed by Microsoft. The original codec, known as WMV, was originally designed for Internet streaming applications, as a competitor to RealVideo.

Video Frame Rate

This entry is used to specify the video recording frame rate to be used for recording the animation as. This entry is important if the recording is to be converted for television broadcasting. The following video frame rates are available:

NTSC National Television System Committee (NTSC) is the analog television system that is/was used in most of the Americas, Japan, South Korea, Taiwan, Burma, and some Pacific island nations and territories. After over a half-century of use, the vast majority of over-the-air NTSC transmissions in the United States were replaced with ATSC on June 12, 2009 and will be by August 31, 2011 in Canada.

PAL Phase Alternating Line (PAL) is an analog television encoding system used in broadcast television systems in large parts of the world. In the 1950s, when the Western European countries were planning to establish color television, they were faced with the problems that the then current NTSC standard demonstrated, including color shifting under poor transmission conditions. For these reasons the of PAL standard was developed to eliminate the problems associated with NTSC.

Custom User-defined frame rate.

ASCII Output Report

An ASCII Output Report is available after each analysis, as shown in the following figure. Select **OUTPUT ► ASCII OUTPUT REPORT** or click the **ASCII OUTPUT REPORT** icon from the Output toolbar to view the report of the analysis model run.

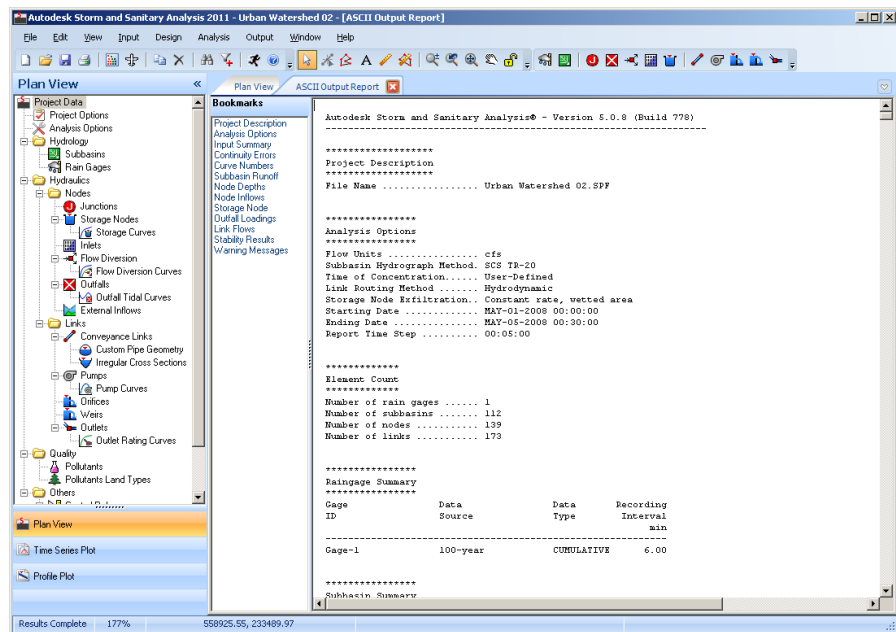



Figure 5.6 The ASCII Output Report provides details of the model analysis

Copying to Clipboard

To copy any text from the ASCII Output Report, first select the text to copy using the mouse and then select **EDIT ► COPY**. Alternatively, right-click and select **COPY** from the displayed context menu. The selected text will then be copied to the Windows clipboard. If the entire report is copied, it is not necessary to first select the text with the mouse. The software will copy all of the report text by default.

Finding an Element on the Plan View

To locate a network element contained within the report, click the **FIND**  icon from the Standard toolbar or choose **EDIT ► FIND**. The Find dialog box is then displayed. From this dialog box, you can then specify the element to search for. For further information, see the section titled *Finding Elements* on page 61.

Analysis Results Bookmark Navigation

To more efficiently browse the analysis results, to the left of the ASCII Output Report is Bookmarks section that allows you to navigate directly to the output section of interest. There is no need for scrolling up and down through the output, looking for the section of concern. Click the bookmark and the software will display the output section selected.

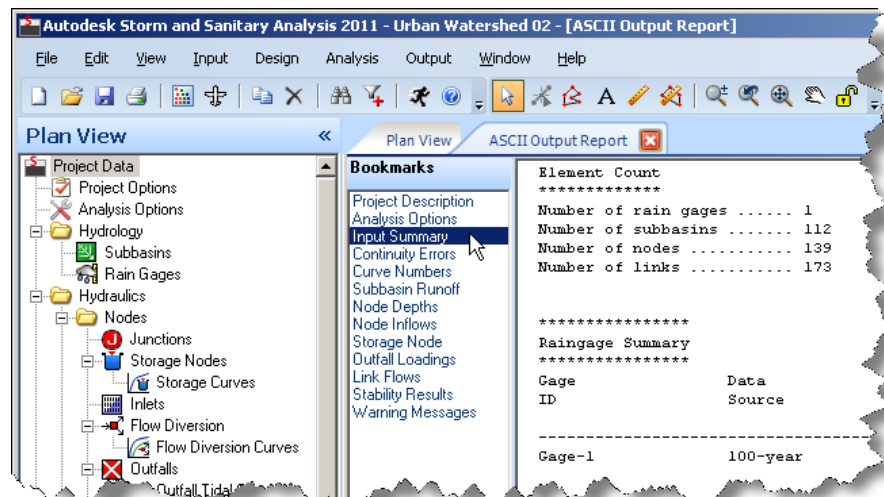

Figure 5.7 Adjacent to the ASCII Output Report is a Bookmarks section, that allows you to navigate directly to the section of interest

Report Sections

The ASCII Output Report contains the following sections:

- 1 Summary of the main Analysis Options that were defined.
- 2 Listing of any error conditions encountered during the simulation.
- 3 Summary listing of input data, if requested in the Analysis Options dialog box.
- 4 Summary of data read from each rainfall file used during the simulation.
- 5 Description of each control rule action taken during the analysis, if requested in the Analysis Options dialog box.

- 6 System wide reporting of mass continuity errors for:
 - Runoff quantity and quality
 - Groundwater flow
 - Conveyance system flow and water quality
- 7 Subbasin runoff summary table that lists the following for each subbasin:
 - Total precipitation (in or mm)
 - Total run-on from other subbasins (in or mm)
 - Total evaporation (in or mm)
 - Total infiltration (in or mm)
 - Total runoff (in or mm)
 - Runoff coefficient (ratio of total runoff to total precipitation)
- 8 Node depth summary table that lists the following for each node:
 - Average water depth (ft or m)
 - Maximum water depth (ft or m)
 - Maximum hydraulic head (HGL) elevation (ft or m)
 - Elapsed time when the maximum water depth occurred
 - Total volume of flooding (inches/acre or mm/hectare)
 - Total minutes flooded
- 9 Conduit flow summary table that lists the following for each conduit:
 - Maximum flow rate (cfs or cms)
 - Elapsed time when the maximum flow rate occurred
 - Maximum flow velocity (ft/sec or m/sec)
 - Ratio of conduit equivalent length used in the simulation to the conduit's defined original length
 - Ratio of the maximum flow to the conduit's design flow (i.e., full normal flow)
 - Conduit design flow (i.e., full normal flow, cfs or cms)
 - Total minutes that the conduit was surcharged (either flowed full or had flow greater than the full normal flow)

- 10 Flow classification summary table (for Hydrodynamic routing only) that lists the following for each conduit:
 - Fraction of time that the conduit was in each of the following flow categories:
 - Dry on both ends
 - Dry on upstream end
 - Dry on downstream end
 - Subcritical flow
 - Supercritical flow
 - Critical flow at upstream end
 - Critical flow at downstream end
 - Average Froude number of the flow
 - Average change in flow over all time steps (cfs or cms)
- 11 Element IDs of the five nodes with the highest individual flow continuity errors.
- 12 Element IDs of the five nodes or conduits that most often determined the size of the time step used for the flow routing (when the Variable Time Step option was specified).
- 13 Range of routing time steps taken and the percentage of these that were considered steady state.

Custom Reports

The software allows you to create a custom formatted report containing both model input data as well as analysis output results. This custom report can then be exported as either a PDF file or Microsoft Excel spreadsheet.

To setup a custom report, select **OUTPUT ► CUSTOM REPORT OPTIONS**. The Custom Report Options dialog box will then be displayed, as shown in the following figure.

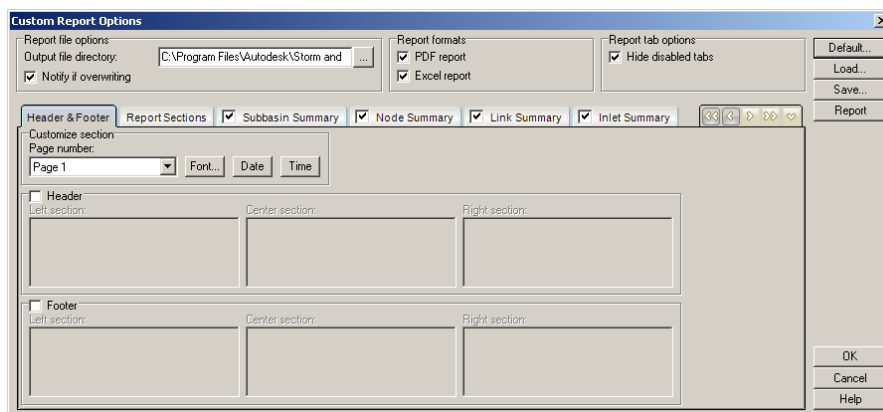



Figure 5.8 The Custom Report Options dialog box allows you to define the format of the report to be generated

The Custom Report Options dialog box provides great flexibility in defining report formats for different reporting needs and requirements. To facilitate the definition of the customized report, tabbed sections are used in the Custom Report Options dialog box to specify the format of each individual report section.

To change the definition of a particular report section, select the tabbed section of interest. Alternatively, the  and  buttons can be used to navigate to the report section. Then, from the selected tabbed section, define the format requirements for that section.

General Options

The following general options are defined at the top of the Custom Report Options dialog box.

Output File Directory

This entry allows you to define the folder (i.e., subdirectory) in which the generated report will be written to. Click the  button to interactively select the folder. Note that the generated report will have the same name as the project file, but with either a **PDF** or **XLS** file extension.

Notify if Overwriting

This check box entry will cause the software to confirm whether to overwrite a previously created report file. If this check box is disabled (i.e., unselected), then the software will automatically overwrite any previous report file with a new report file.

Note that if a previously created report file is already open by another software, such as Adobe Acrobat Reader or Microsoft Excel, then the software will not be able to overwrite the file and will generate an error message.

Report Formats

This section allows you to choose the format that the report is to be generated as. Select the check box corresponding to the desired report formats to be generated.

Header & Footer Tab

The Header & Footer tab allows you to define the report's header and footer. The header or footer can include the page number, current date and time, and other information. In addition, the header and footer text style can be formatted by highlighting the text, and then clicking the Font button. A font dialog box will then be displayed, allowing you to format the text.

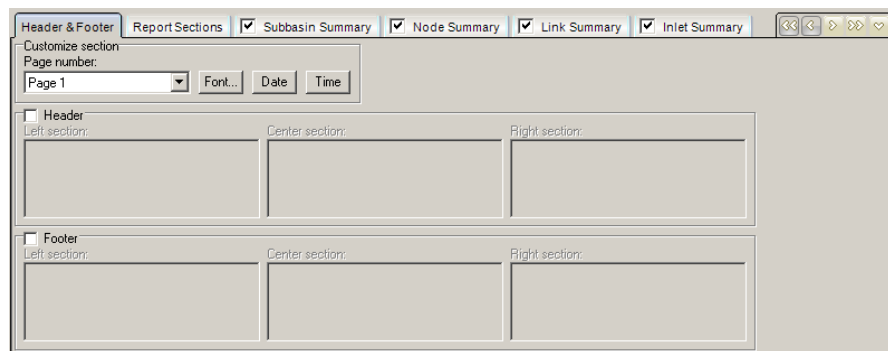

Figure 5.9 The Header & Footer tab defines the report's header and footer

Report Sections Tab

The Report Sections tab allows you to define what report sections to include in the custom report. Unchecking a report section from the displayed list will remove that section from the generated report, as well as remove the corresponding tab used to define the details of that section.

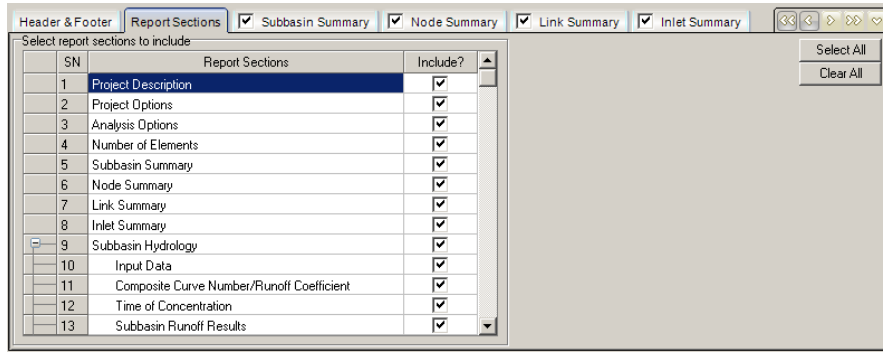

Figure 5.10 The Report Sections tab defines what sections to include in the report

Individual Elements Tab

The remainder of the tabbed sections specify the element report sections to include the generated report. Note that what analysis options have been selected will change what data is presented in each section tab. For example, in the Subbasin Summary tab, as shown in the following figure, the various data used to define the subbasin as well as the resultant output data is dependent upon the hydrology method selected in the Analysis Options dialog box.

Each element report section allow you to define which data to include in that section of the generated report. Unchecking an individual data item will remove the data item from the report. In addition, you can change the data label, specify the decimal precision, change the units to display the data as, and change the order that the data will be listed within the section.

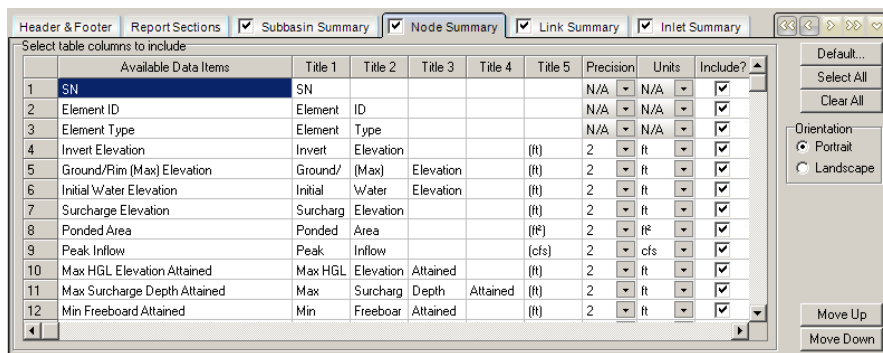

Figure 5.11 Each of the elements that make up the model are defined on individual tabbed sections, allowing you total control on how to present the input data and output results in the generated report

The available formatting options for each report section tab are described below.

Available Data Items

This read-only column lists the available data items that can be included in the generated report.

To change the order of a data item within the report, select the corresponding row and then click either the Move Up or Move Down button. The selected row will then be moved.

Title 1 ... Title 5

These five columns define the table column heading for each data item to be included in the generated report. The specified table column heading can contain up to five rows of text, with up to 20 characters for each row. However, for extensive tables (i.e., with lots of columns), it is advised to keep the text labels relatively short.

Precision

This column defines the decimal point precision that the data items are to be reported with.

Units

This column defines the units of measure that the data items are to be reported with.

Include?

This column defines which data items are to be included in the generated report.

Orientation

This radio button group defines the orientation of the table within the generated table. For wider tables, a **LANDSCAPE** orientation would be better since it allows more columns than a **PORTRAIT** orientation.

Saving a Report Template

Once the report format has been defined, it can then be saved as a template allowing you to recreate the report the next time a project is run. Multiple different report formats can be created and saved for different reporting requirements, allowing you to select the required report template and then instantly generate the report of interest. Click the Save button to interactively select the folder and define the filename in which the report template file is to be saved.

Loading a Report Template

Once the report format has been defined, all subsequent uses of the software will use the newly defined report format. However, different projects may require a different report format, depending upon the reporting requirements of the engineering project. If multiple report templates have been previously defined and saved, click the Load button and interactively select the report template required. The software will display a file selection dialog box allowing the desired report template to be selected.

Default Report Template

To reset the report format back to its default definition, click the Default button. The software will confirm that the report format is to be restored back to its default definition.

Generating a Report

Once a report format has been defined, click the Report button from within the Custom Report Options dialog box. The software will then generate the report.

Alternatively, a report can be generated by selecting **OUTPUT ► GENERATE CUSTOM REPORT** or clicking the **GENERATE CUSTOM REPORT** icon from the Output toolbar.

Excel Table Reports

The software can display its simulation results directly within Microsoft Excel. This allows you maximum flexibility in customizing the output reports.

As shown in the following figure, select **OUTPUT ► EXCEL TABLE REPORTS** or click the **EXCEL TABLE REPORTS** icon from the Output toolbar. The software will automatically startup Excel and display the output reports.

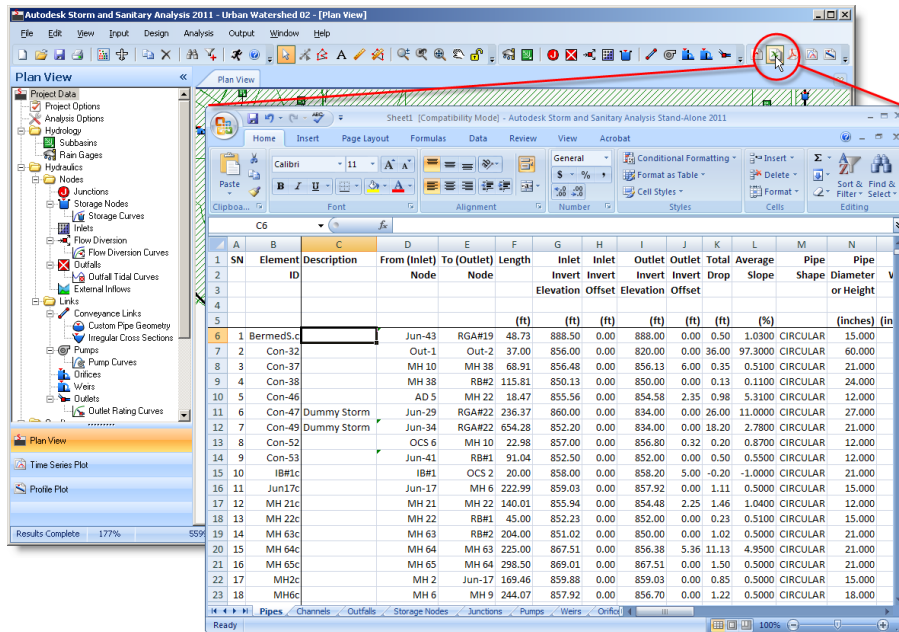

Figure 5.12 Both input data and simulation results for all network elements can be directly displayed within Excel

Note both the input data and the simulation results for all network elements will be displayed within Excel. If the analysis simulation has not yet been performed, then only the network element input data will be displayed within Excel. If Microsoft Excel is not installed on the computer system, then these reports cannot be generated.

Viewing Results on Plan View

There are several ways to view the input parameter values and analysis results on the drainage network in the Plan View.

Property Mapping

The Properties section of the Display Options dialog box, shown in the following figure, allows you to define how subbasins, nodes, and links are color-coded based on a selected input or output property.

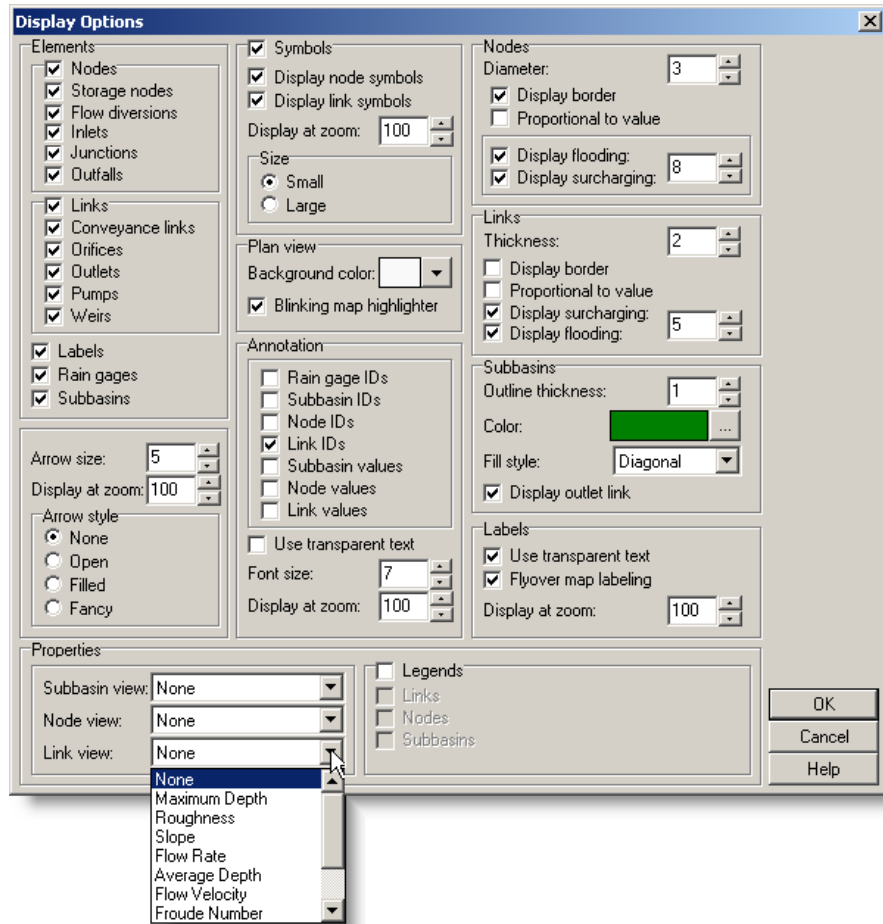

Figure 5.13 The Display Options dialog box allows you to define how subbasins, nodes, and links are color-coded based upon a selected input or output property

The Plan View will then display the elements similar to those shown in the following figure. See the section titled *Display Options* on page 25 for more information on how to perform a property mapping.

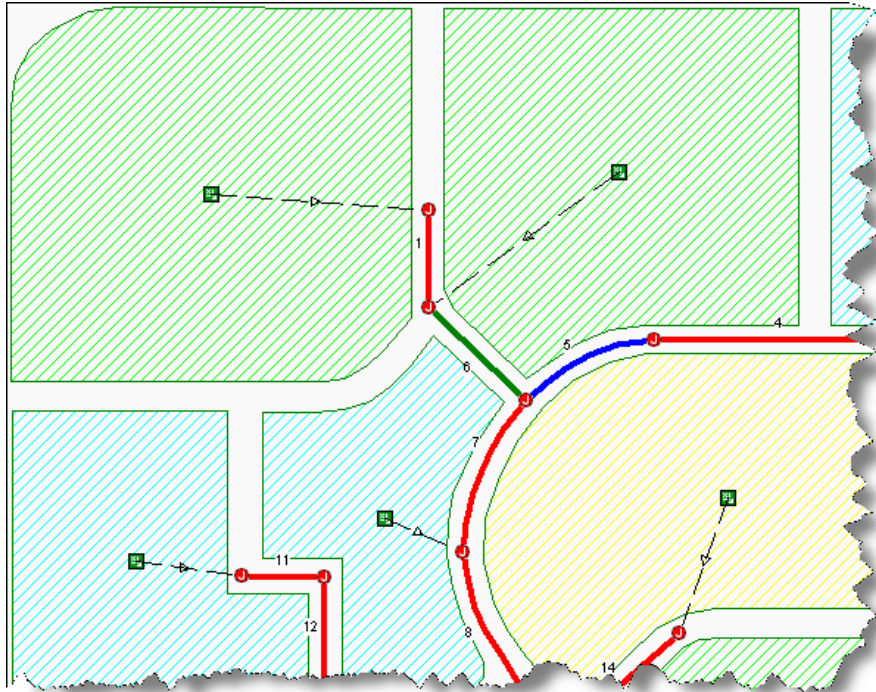

Figure 5.14 The Properties section of the Display Options dialog box allows you to color-code subbasins, nodes, and links based upon an input or output property

Simulation Date & Time

After running the simulation, the software will display the simulation date and time in the upper right corner of the Plan View. The displayed simulation date and time can be dragged to another location on the Plan View, if desired.

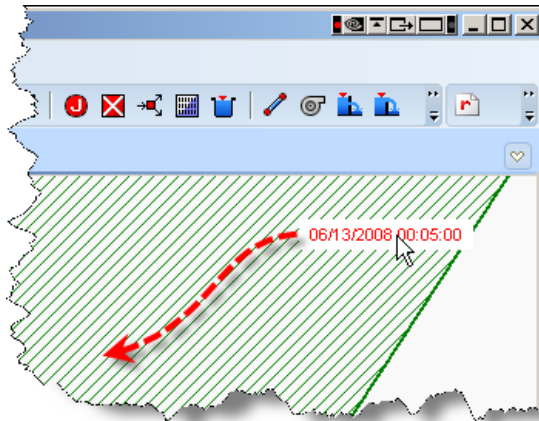

Figure 5.15 To displayed simulation date and time can be dragged to another location on the Plan View

The Plan View Display Options dialog box allows you to turn on and off the display of this displayed simulation date and time.

Flyover Property Labeling

If the FLYOVER MAP LABELING check box is selected in the Display Options dialog box, moving the mouse over an element on the Plan View will cause the element

ID label and the value of the selected property to be displayed adjacent to the network element.

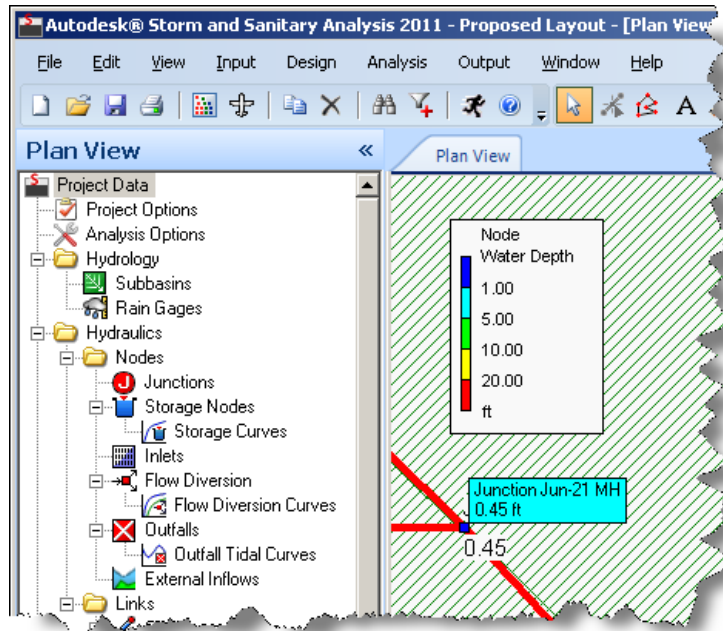

Figure 5.16 The Flyover Map Labeling option will cause the selected property to be displayed adjacent to the network element

Nodal Mapping

Element ID and property values can be displayed next to all subbasins, nodes, and links if the appropriate options are specified in the Display Options dialog box.

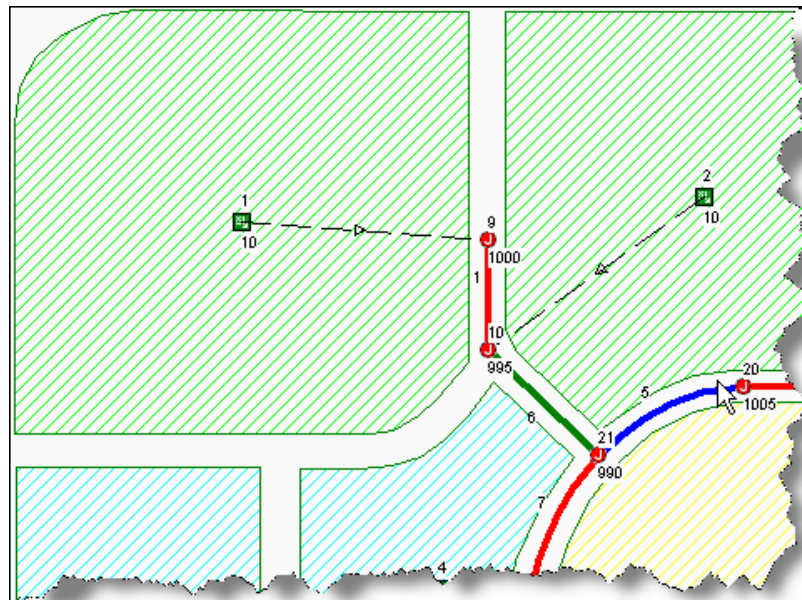

Figure 5.17 The element ID and property values can be displayed next to all subbasins, nodes, and links

Querying

Subbasins, nodes, and links meeting specific selection criteria can be identified on the Plan View using a query, as shown in the following figure. See the section titled *Querying Elements* on page 62 for more information on how to perform a query.

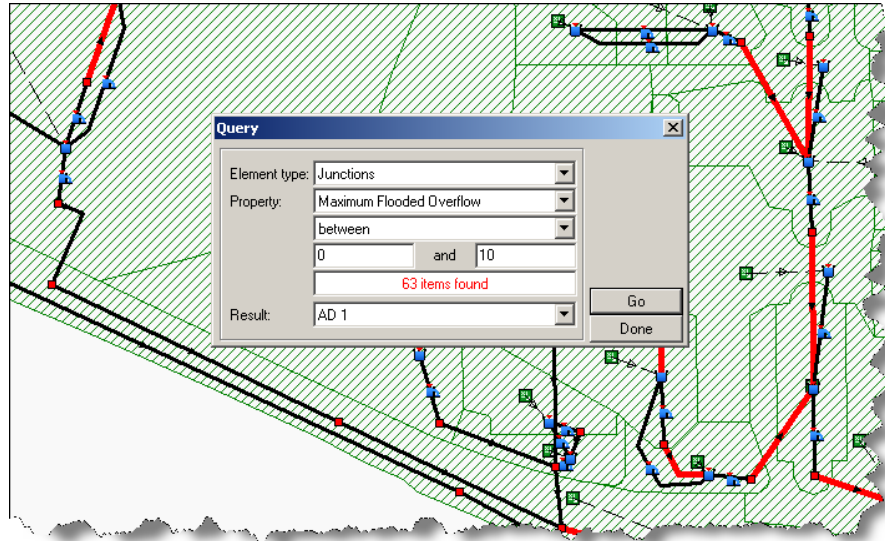

Figure 5.18 A Query will display those elements that meet the specified criteria

Animating

The Output Animation dialog box allows animation of the analysis results with regard to simulation time on the Plan View. To display the Output Animation dialog box, select **OUTPUT ► OUTPUT ANIMATION**.

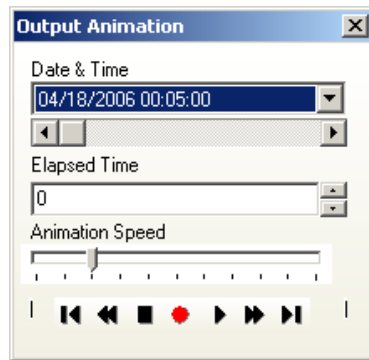

Figure 5.19 The Output Animation dialog box allows you to animate the analysis results on the Plan View

To animate the analysis results with time, use the provided buttons to control the animation. For example, clicking the **PLAY ►** button will run the animation forward in time. For more information on controlling the animations, see the section titled *Output Animation* on page 110.

The Plan View animation can be recorded to a video file, allowing you to play the animation back without requiring the use of the software. Alternatively, you can embed the videos in a PowerPoint presentation. For more information on recording the animations, see the section titled *Recording Animations* on page 112.

Printing, Copying, and Exporting

To print the Plan View, right-click the Plan View and select **PRINT** from the displayed context menu. The Print dialog box is then displayed, allowing you to select the printer and print options you want for printing the Plan View.

To copy the Plan View, right-click and select **COPY**. The Plan View will then be copied to the Microsoft Windows clipboard, allowing you to paste it directly into other Windows programs, such as Microsoft Word.

To export the Plan View, right-click and select **EXPORT**. The Export dialog box is then displayed, allowing you to define the file format to export the Plan View as. The Plan View can be exported as an AutoCAD DWG or DXF drawing file or Microsoft Windows Enhanced Metafile. See the chapter titled *Importing and Exporting* on page 471 for more information.

Profile Plots

Profile plots as shown in the following figure, display the computed water depth along a specified path of the sewer network. Profile plots are sometimes referred to as *long sections* or *longitudinal sections*. Once the profile plot has been created, it will automatically update when a new time step is selected in the Output Animations dialog box. For more information on the Output Animations dialog box, see the section titled *Output Animation* on page 110.

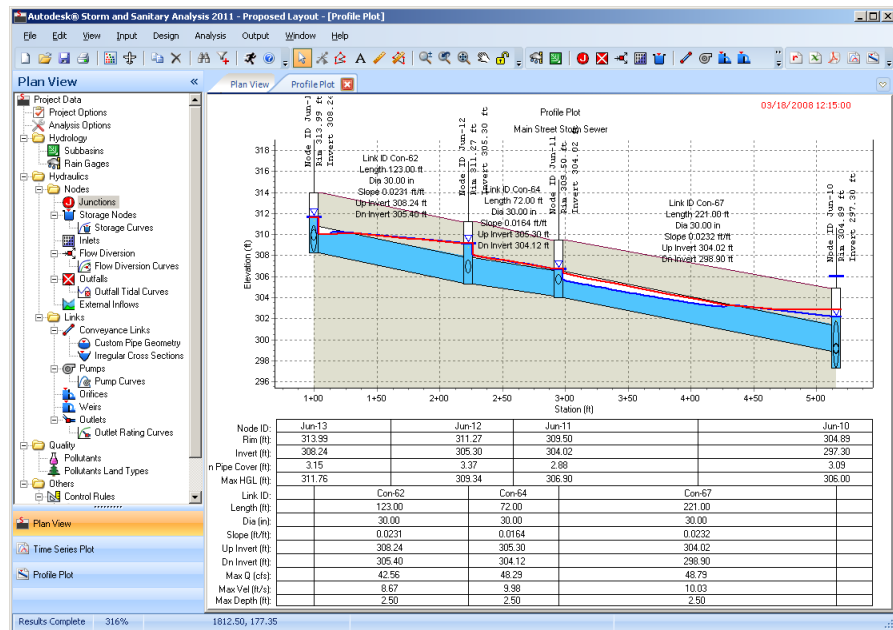

Figure 5.20 Profile plots display the computed water depth along a specified path in the sewer network

To create a profile plot:

- 1 Click the **PROFILE PLOT** icon from the Output toolbar or choose **OUTPUT > PROFILE PLOT**.
- 2 The Profile Plot docked dialog panel is then displayed on the left side of the application, as shown in the following figure. This docked dialog panel is used to define the path along which the profile plot will be generated.

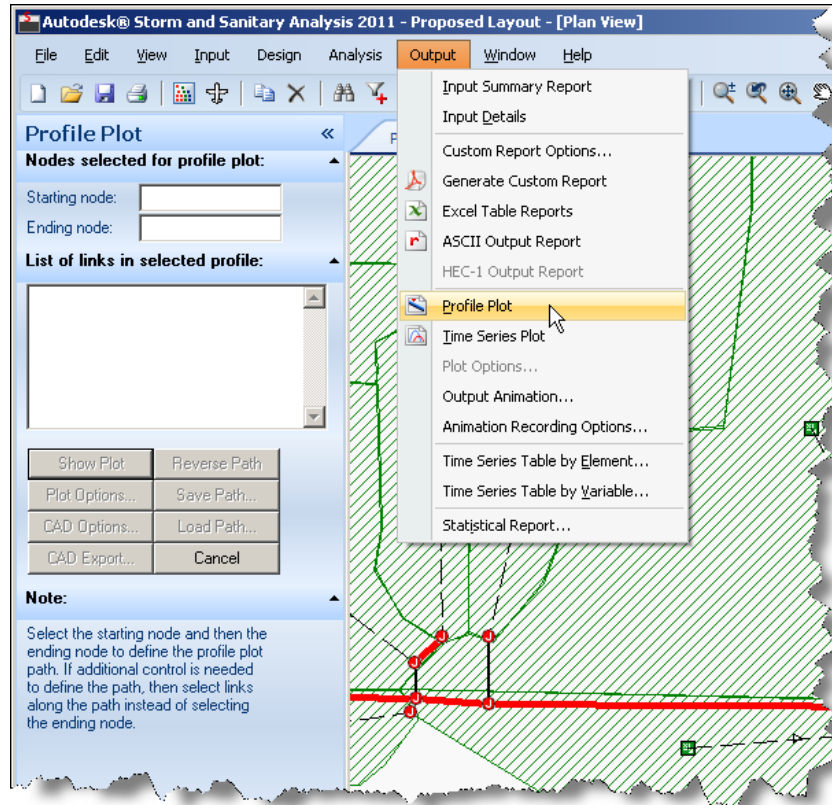
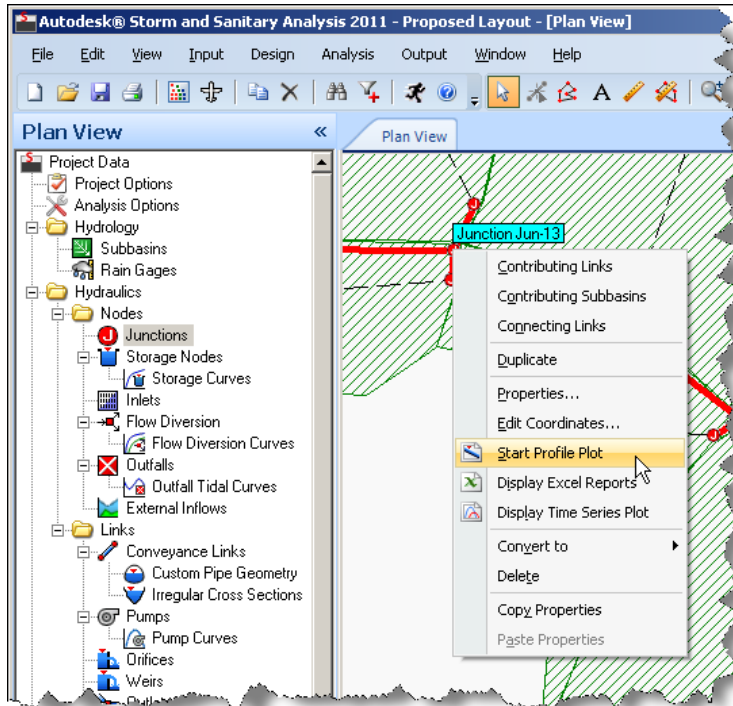

Figure 5.21 The Profile Plot docked dialog panel is used to define the path for the profile plot

- 3 To define the path for the profile plot, select the upstream node from the Plan View by clicking the node. The software will automatically add this node to the **STARTING NODE** data field in the Profile Plot dialog box.

Alternatively, instead of following previously defined steps, on the Plan View right-click the node to start at and choose **START PROFILE PLOT** from the displayed context menu.



*Figure 5.22 A faster way of starting a profile plot is to right-click the starting node and choose **Start Profile Plot** from the displayed context menu*

- 4 Next, select the downstream node from the Plan View by clicking the node. The software will automatically add this node to the **ENDING NODE** data field in the docked dialog panel.

Once the starting and ending nodes are defined, the software will automatically determine the shortest path between the specified starting and ending nodes. The links that make up this path will then be listed in the docked dialog panel.

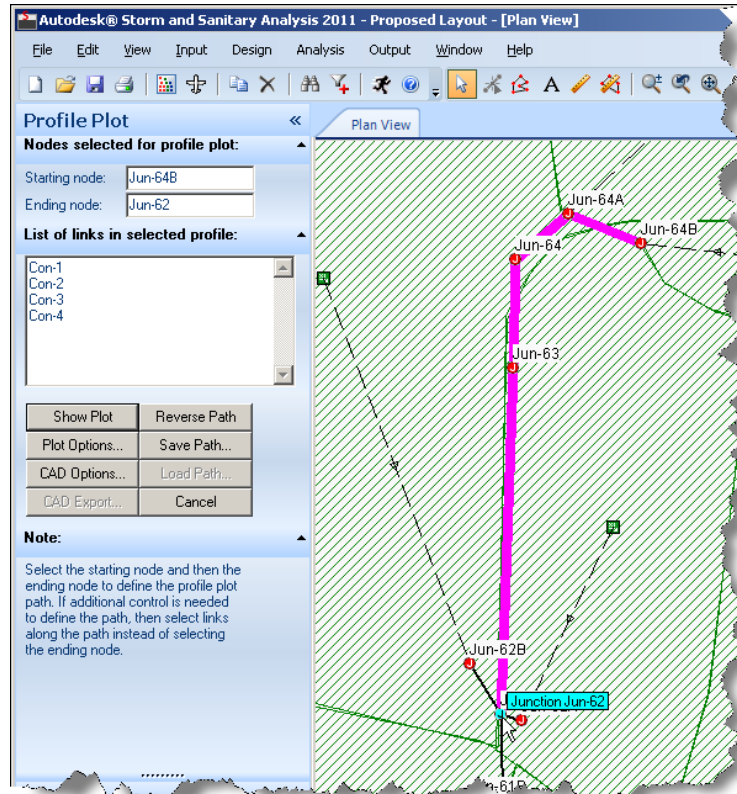

Figure 5.23 After selecting the starting and ending nodes, the software will automatically determine the shortest path between the nodes

- 5 If more control is desired in the profile plot path that the software determined (in the event that more than one path is available), you can click the selected links in the Plan View to back-up the profile plot path to the location you want the plot to change direction. Then, click the links that make up the desired profile plot path.
- 6 After the profile plot path has been defined, click the Show Plot button in the docked dialog panel. The profile plot is then displayed, similar to what is shown in Figure 5.20 on page 125.

Redefining the Profile Path

To redefine the current set of links that make up the profile plot:

- 1 Right-click the displayed profile plot. From the displayed context menu, select **REDEFINE PATH**.

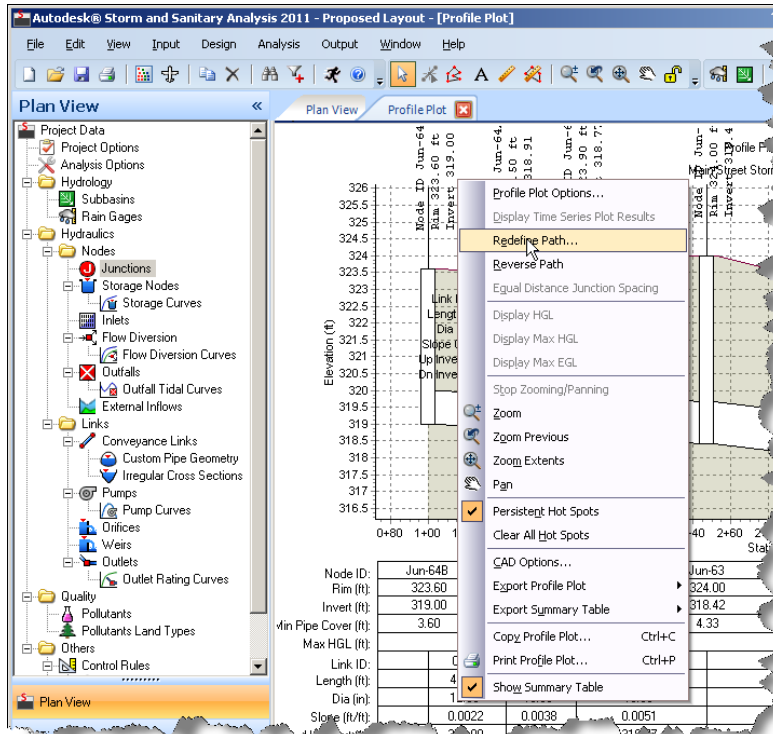

Figure 5.24 After a profile plot has been created, the path can be redefined

- 2 The software will again display the Profile Plot docked dialog panel, and you can choose a different path.

Saving the Current Profile Path

To save the current set of links that make up the profile plot, allowing you to display the same profile plot at some future time:

- 1 After defining the profile plot path and before displaying the profile plot, click the Save Path button in the docked dialog panel.

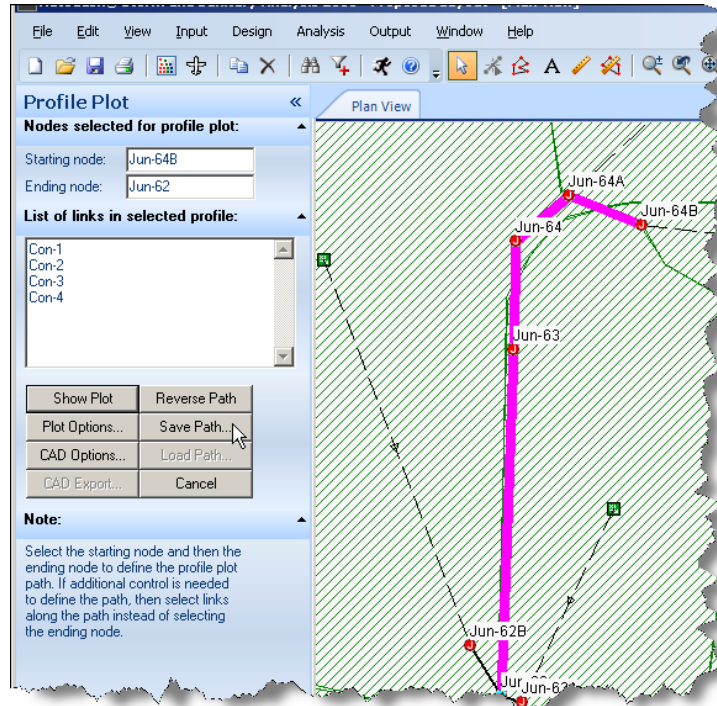

Figure 5.25 The selected profile plot path can be saved for later re-use

- 2 The Save Path dialog box is then displayed.

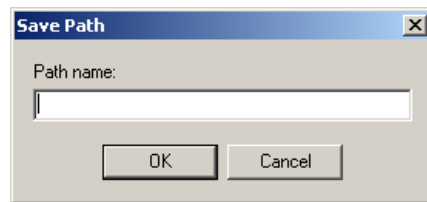



Figure 5.26 Define the profile plot path name

- 3 From the displayed Save Path dialog box, define the path name and click OK.

Loading a Previously Defined Profile Path

To use a previously defined path for a profile plot:

- 1 Click the **PROFILE PLOT**  icon from the Output toolbar or choose **OUTPUT ► PROFILE PLOT**.
- 2 From the displayed Profile Plot docked dialog panel, click the Load Path button. Note that if a profile plot path has not been previously saved, then this button will be grayed out (unavailable).

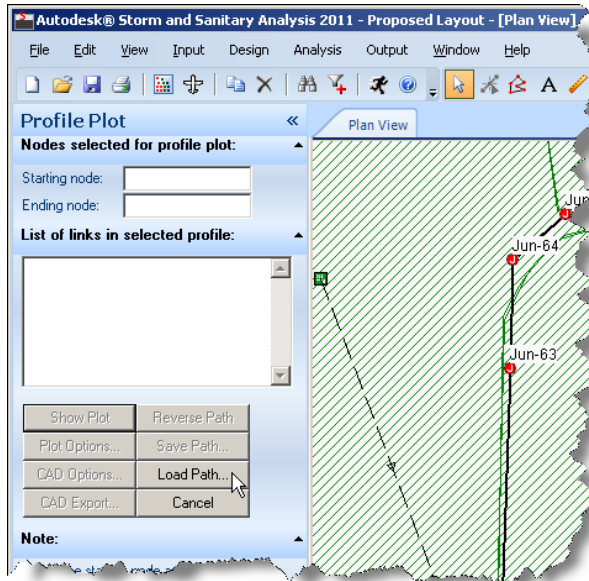

Figure 5.27 A previously defined profile plot path can be loaded for displaying the same path that was defined earlier

- 3 The Load Path dialog box is then displayed.

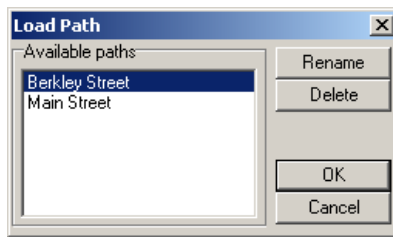

Figure 5.28 Select the profile plot path to load

- 4 From the displayed Load Path dialog box, select a previously defined path from the list of available paths and click OK.
- 5 Click the Show Plot button from the Profile Plot docked dialog panel. The profile plot is then displayed, as shown previously in Figure 5.20 on page 125.

Right-Click Context Menu

The software provides a great deal of additional commands within the profile plot right-click context menu, as shown in the following figure.

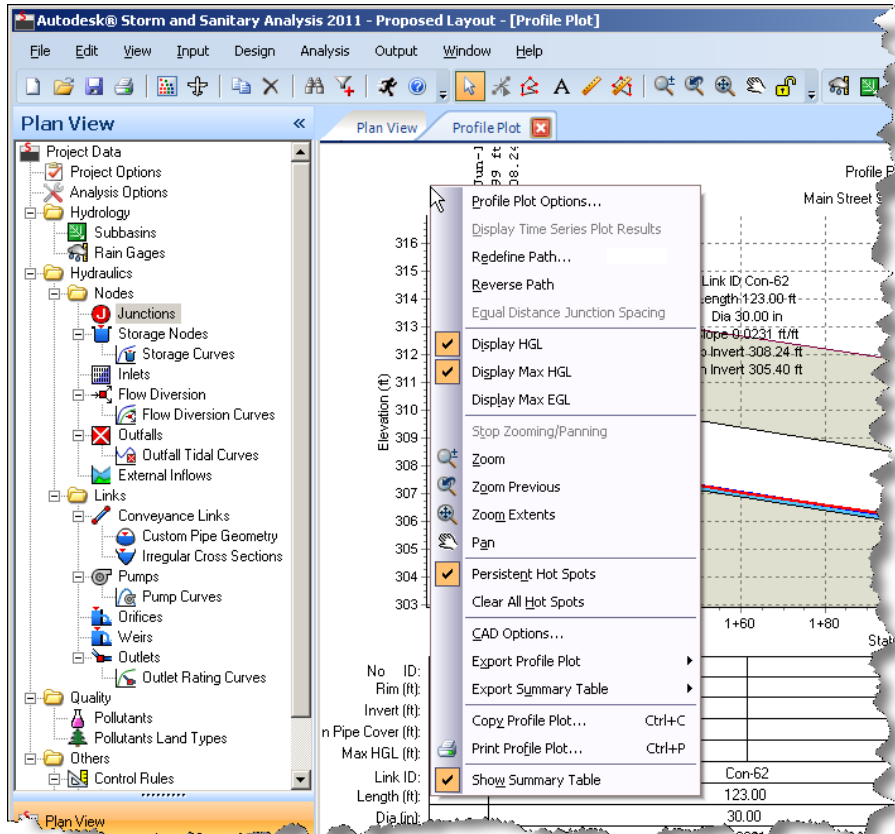

Figure 5.29 Numerous commands are available from the right-click context menu

Customizing the Profile Plot

The software allows extensive customization of the profile plots. To customize the current profile plot:

- 1 Right-click the displayed profile plot. From the displayed context menu, select **PROFILE PLOT OPTIONS**.

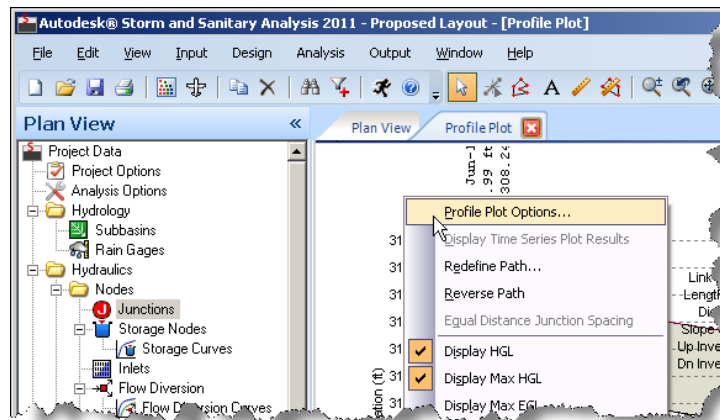

Figure 5.30 Right-click and select Profile Plot Options

- 2 The Profile Plot Options dialog box is then displayed, as shown in the following figure.

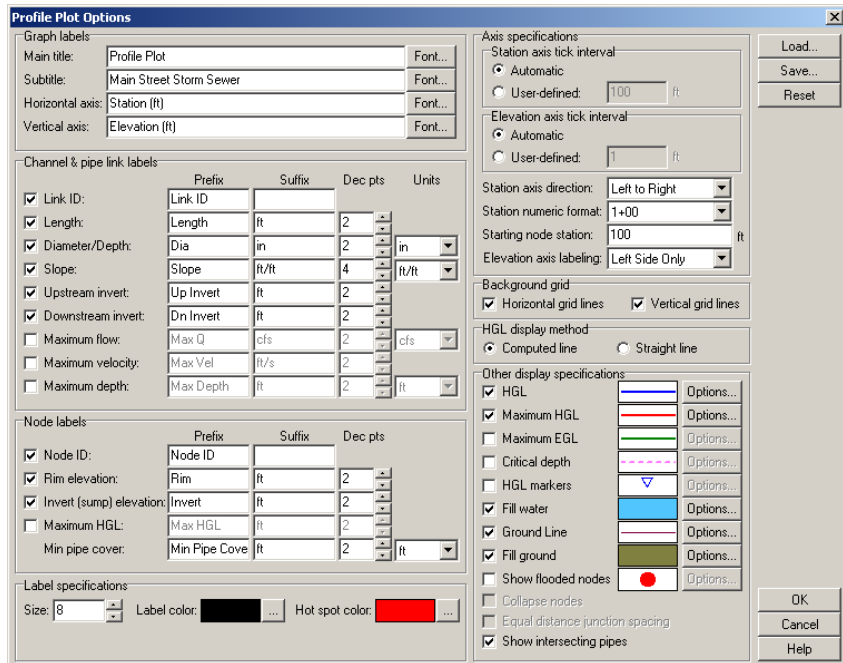

Figure 5.31 The Profile Plot Options dialog box is used to customize the displayed profile plot

- 3 Numerous options are available from the Profile Plot Options dialog box for customizing the displayed profile plot.
- 4 The Save button allows you to save your settings for later re-use. The Load button allows you to load a previously saved settings for use. Whatever changes to the profile plot display options are created will then apply to all new profile plots when they are first created. To reset the profile plot display options back to “factory defaults,” click Reset.
- 5 Once the changes have been specified in the Profile Plot Options dialog box, click OK to apply these changes to the displayed plot.

Summary Table Section

As shown in the following figure, the bottom of the profile plot contains a Summary Table section detailing variables of interest.

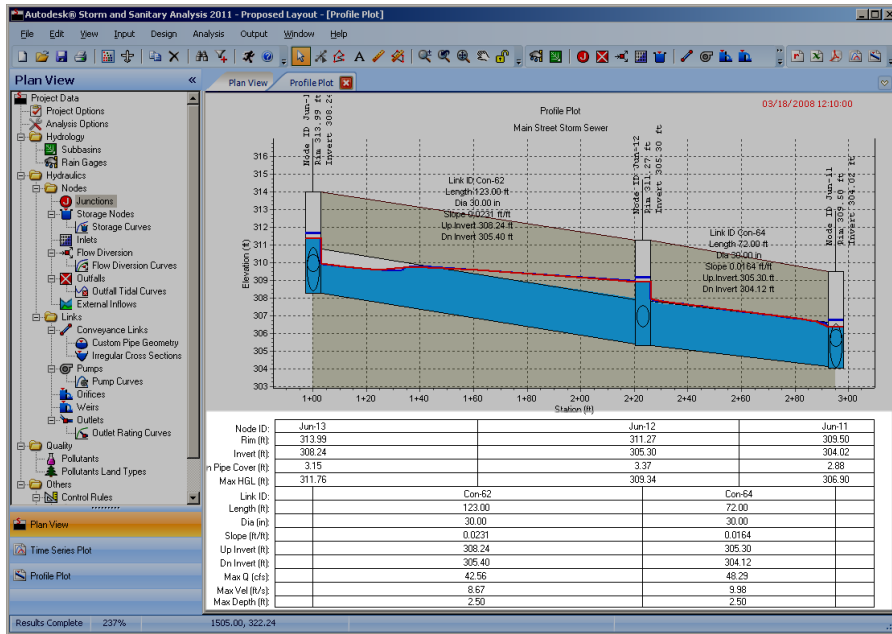

Figure 5.32 The Summary Table section (see highlighted section) details various variables of interest along the profile plot

The Summary Table section includes:

- Node ID
- Rim Elevation
- Invert Elevation
- Minimum Pipe Cover
- Maximum HGL Elevation
- Link ID
- Length
- Diameter
- Slope
- Upstream Invert Elevation
- Downstream Invert Elevation
- Maximum Discharge
- Maximum Velocity
- Maximum Water Depth

To close the Summary Table section, right-click and uncheck the **SHOW SUMMARY TABLE** item from the displayed context menu, as shown in the following figure. This will clear the check mark (✓) from in front of the menu item.

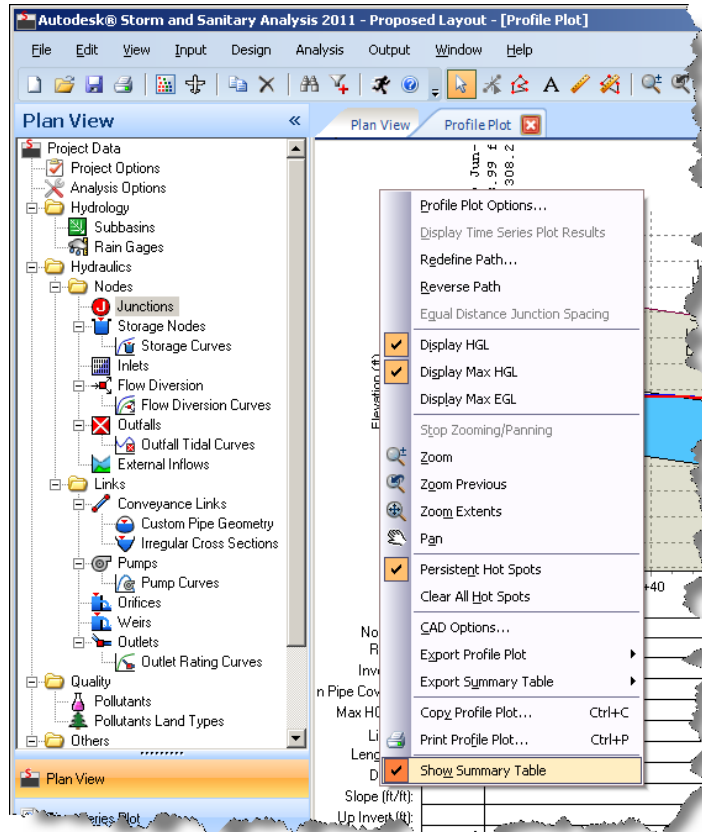

Figure 5.33 The Summary Table at the bottom of the profile plot can be hidden if desired

The data shown within the Summary Table section can be exported out to Microsoft Excel or Word. Right-click the profile plot and choose **EXPORT SUMMARY TABLE ► EXPORT TO EXCEL** or **EXPORT TO WORD** from the displayed context menu.

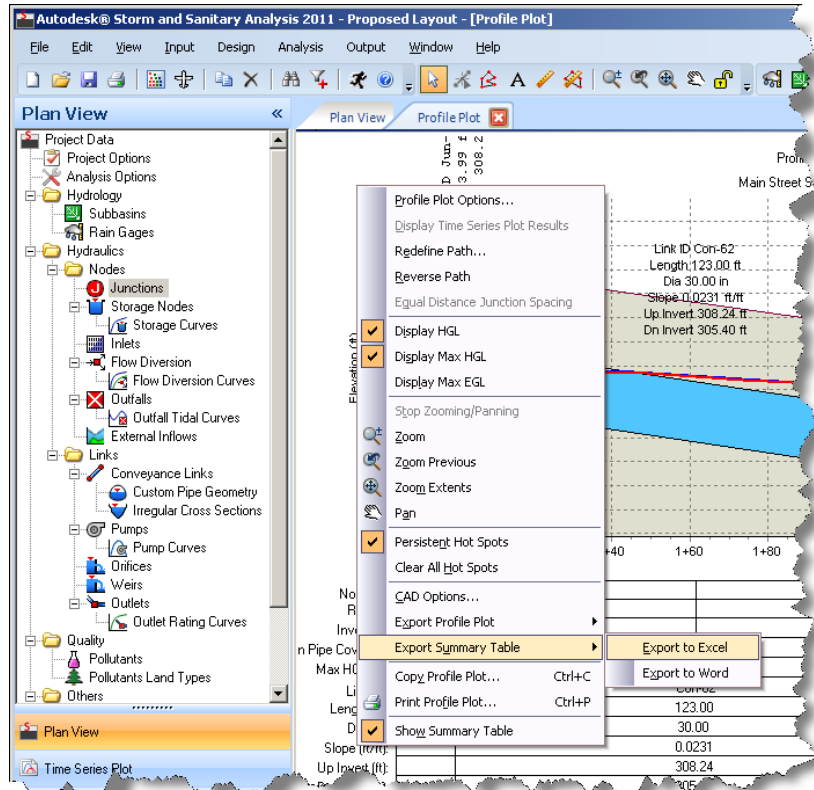

Figure 5.34 The Summary Table section can be exported out to Microsoft Excel or Word

Zooming and Panning

To zoom in and out on the profile plot and if the mouse has a scroll wheel, scroll the wheel to zoom in and out. Alternatively, use the **ZOOM** tool and drag a zoom window (with the left mouse button held down) horizontally (left to right or right to left) to zoom in. Hold down the Shift key and click to zoom out. To zoom to the full extents of the profile plot, right-click the plot and select **ZOOM EXTENTS** from the displayed context menu.

To pan the profile plot in any direction and if the mouse has a scroll wheel (or a middle button), hold it down and drag to pan. Alternatively, use the **PAN** tool and drag with the left mouse button held down to pan.

Animating

The Output Animation dialog box allows animation of the analysis results with regard to simulation time on the Profile Plot. To display the Output Animation dialog box, select **OUTPUT ► OUTPUT ANIMATION**.

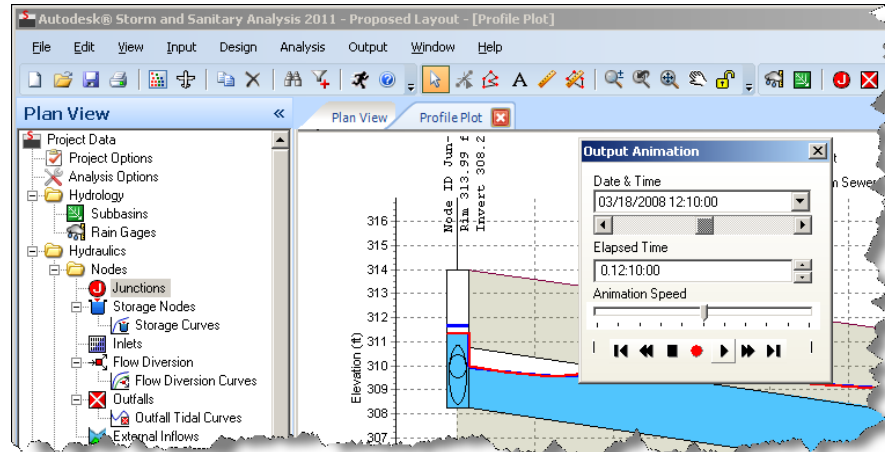

Figure 5.35 The Output Animation dialog box allows you to animate the analysis results on the Profile Plot

To animate the analysis results with time, use the provided buttons to control the animation. For example, clicking the **PLAY** button will run the animation forward in time. For more information on controlling the animations, see the section titled *Output Animation* on page 110.

The Profile Plot animation can be recorded to a video file, allowing you to play the animation back without requiring the use of the software. Alternatively, you can embed the videos in a PowerPoint presentation. For more information on recording the animations, see the section titled *Recording Animations* on page 112.

Printing, Copying, and Exporting

To print the profile plot, right-click the plot and select **PRINT PROFILE PLOT** from the displayed context menu. The Print Profile Plot dialog box is then displayed, as shown in the following figure. This dialog box allows you to select the contents to be printed. After selecting the desired output contents and clicking OK, the software will then provide you with the standard Windows Print dialog box where the printer selection and print options are available for printing the profile plot.

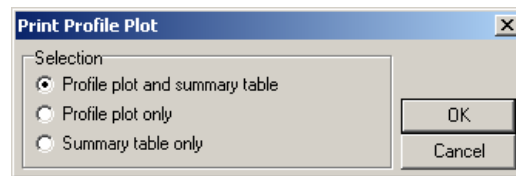

Figure 5.36 The software allows you to select the contents to be printed

To copy the profile plot, right-click and select **COPY PROFILE PLOT** from the displayed context menu. The Copy Profile Plot dialog box is then displayed, allowing you to select the contents to be printed. This dialog box is similar to the Print Profile Plot dialog box shown in the above Figure 5.36. After selecting the desired output contents and clicking OK, the software will then copy the profile plot to the Microsoft Windows clipboard, allowing you to paste the plot directly into other Windows programs, such as Microsoft Word.

To export the profile plot, right-click and select **EXPORT PROFILE PLOT** and then select the desired file format. The Export dialog box is then displayed, allowing you to define the file format to export the profile plot as.

CAD Exporting

The software can export the profile plot in a format similar to what is used in construction drawings. To export the profile plot, right-click the profile plot and click **EXPORT PROFILE PLOT ► CAD EXPORT**. A Save As dialog box is displayed, allowing you to define the directory and filename of the profile plot to be saved.

In addition, you can control the various options when exporting the profile plot to a CAD drawing file. Prior to exporting the profile plot, right-click the profile plot and click **CAD OPTIONS**. The CAD Options dialog box is then displayed, as shown in the following figure.

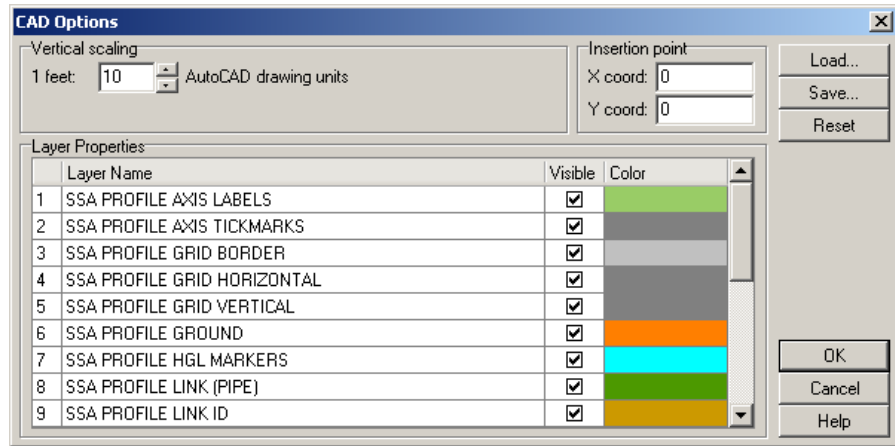

Figure 5.37 The software allows you to control some of the options when exporting the profile plot to a CAD drawing file

All network elements (i.e., junctions, pipes, etc.) are stored on their own individual layers, allowing you to quickly change colors, line styles, text styles, etc. You can change the default settings, such as colors and annotations, to fit your corporate CAD standards. This greatly speeds up the delivery of final deliverables associated with engineering projects.

Exported profile plots include:

- Maximum HGL
- Maximum EGL
- Maximum discharge
- Maximum flow depth
- Maximum flow velocity
- Pipe dimensions (lengths, diameters, invert elevations, etc.)
- Sump and rim elevations

Some of the export options include the following:

Vertical Scaling

This spin control allows you to vary the vertical scaling, relative to the horizontal scaling. The profile plot horizontal scale is 1 drawing unit per foot (or meter). The default profile plot vertical scale is 10 drawing units per foot (or meter), but can be varied. In this way, it is possible to exaggerate the vertical scaling relative to the horizontal scaling.

Insertion Point

This field allows you to specify the X and Y coordinate for the lower left corner of the profile grid. This allows you to control the insertion point of the exported profile plot, when inserted as a block into another drawing file.

Layer Properties

This table controls what drawing layers (and corresponding elements) are exported out, as well as what the layer (and corresponding element) colors are.

Automatic Updating of Plots

The current displayed profile plot will automatically update when the analysis is re-run.

Calculation of Energy Grade Line (EGL)

After computing the hydraulic grade line, the maximum entrance and exit velocities for each pipe is calculated. From these velocities, the corresponding velocity heads are computed. These velocity heads are then used to compute (and plot) the energy grade line for each conveyance links.

Interpretation of HGL and EGL

The following items are useful when interpreting the HGL and EGL.

- 1 As the velocity goes to zero, the HGL and the EGL approach each other. Thus, at a reservoir, they are identical and lie on the surface.
- 2 The EGL and HGL slope downward in the direction of the flow due to the head loss in the pipe. The greater the loss per unit length of pipe, the greater the slope. As the average velocity in the pipe increases, the loss per unit length increases.
- 3 A sudden change occurs in the HGL and EGL whenever a loss occurs due to a sudden geometry change, as represented by:
 - Sudden expansion or reduction in pipe diameter
 - Change in open channel width
 - Internal control structure, such as a weir, orifice, or valve
- 4 A jump in the HGL and EGL occurs whenever useful energy is added to the flow, as would occur with a pump, and a drop occurs if useful energy is extracted from the flow, as would happen with a drop in pipe invert elevation at a manhole.
- 5 At points where the HGL passes through the centerline of a pipe, the pressure is zero.
- 6 If a pipe lies above the HGL, there is a vacuum in the pipe—a condition that should be avoided, if possible, in the design of piping systems; an exception would be in the design of a siphon.

Time Series Plots

Time series plots, as shown in the following figure, display the value of any output result with regard to time for any location in the drainage network. These plots are sometimes referred to as hydrograph plots.

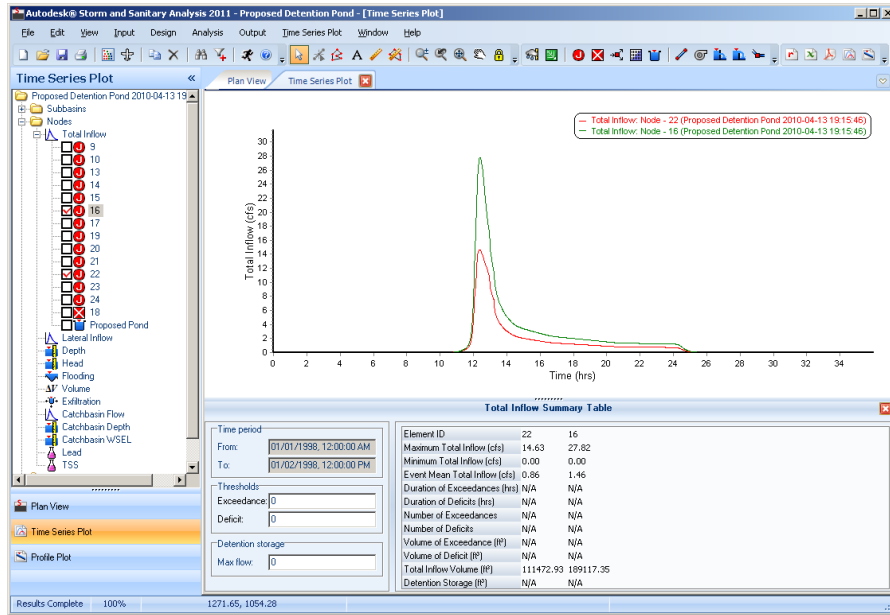

Figure 5.38 Time series plots can display the value of any output result with regard to time for any element in the drainage network

Output Variable Tree

The Output Variable Tree, as shown in the following figure, lists the output variables available to be graphical plotted for subbasin, node, and link elements. In addition, system output variables can be plotted.

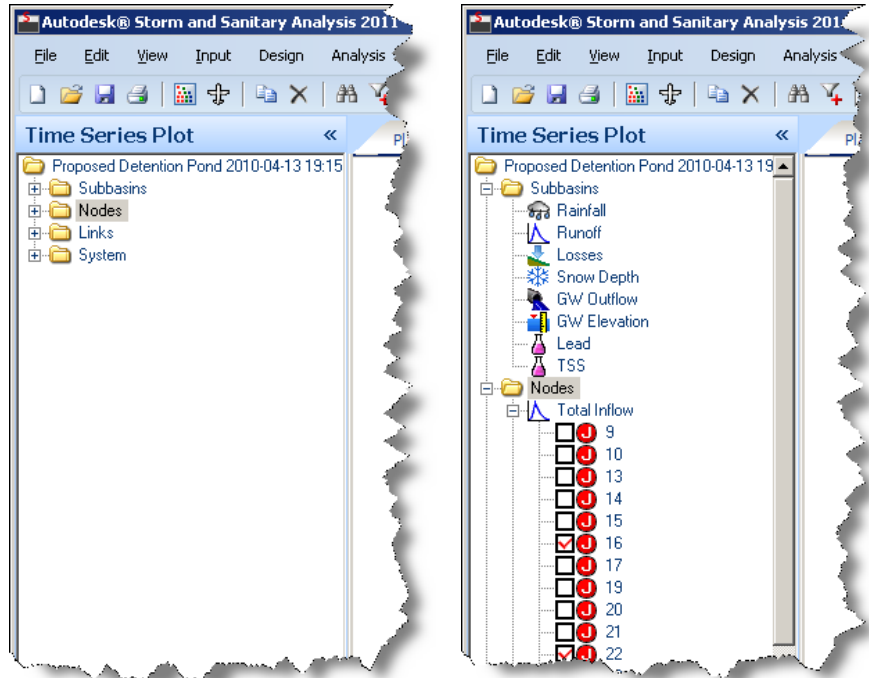

Figure 5.39 The Output Variable Tree can be expanded and collapsed to show subcategories of network elements and output variables

Expand and collapse a particular subcategory within the Output Variable Tree by clicking the category or selecting the **EXPAND** or **COLLAPSE** icons. To display the output results for a particular network element, check the box adjacent to the listed element. The Time Series Plot Window is updated with the results.

Subbasin Output Variables

For subbasins, the following output variables can be plotted:

Groundwater Elevation	(ft or m)
Groundwater Flow	Groundwater flow into drainage network (cfs or cms)
Loss Rate	Infiltration + evaporation (in/hr or mm/hr)
Rainfall Rate	(in/hr or mm/hr)
Runoff Flow Rate	(cfs or cms)
Snow Depth	(in or mm)
Water Quality	Washoff concentration or each pollutant (mass/liter)

Node Output Variables

For nodes (i.e., junctions, outfalls, flow diversions, storm drain inlets, and storage nodes), the following output variables can be plotted:

Exfiltration	Exfiltration (sometimes called infiltration) from a detention pond and other storage elements (cfs or cms)
Flooding Flow Rate	Surface flooding (inflows lost from the system when the water depth exceeds the defined maximum node depth, cfs or cms)
Catchbasin Flow	Total flow in the inlet catchbasin considering the inlet intercepted flow and flow from any connected storm sewers (cfs or cms).
Catchbasin Depth	Total depth of water in the inlet catchbasin (ft or m)
Catchbasin WSEL	Total water surface elevation in the inlet catchbasin (ft or m)
Lateral Inflow	Runoff + all other external inflows (cfs or cms)
Total Inflow	Lateral inflow + upstream inflows (cfs or cms). For inlets, total flow coming up to the inlets. This is the summation of total intercepted flow and bypass flow for storm drain inlet.
Volume	Water volume held in storage (including ponded water, ft ³ or m ³)
Water Depth	Water depth above node invert (ft or m). For inlets, water depth above storm drain inlet structure rim elevation.
Water Surface Elevation	Water surface elevation above node invert (ft or m). For inlets, water surface elevation above storm drain inlet structure rim elevation.
Water Quality	Concentration of each pollutant after treatment (mass/liter)

Link Output Variables

For links (i.e., channels, pipes, pumps, orifices, weirs, and outlets), the following output variables can be plotted:

Average Depth	Average water depth (ft or m)
Capacity Ratio	Ratio of Depth to Full Depth
Flow Rate	(cfs or cms)
Flow Velocity	(ft/sec or m/sec)
Froude Number	
Maximum Depth	Maximum water depth (ft or m)
Water Quality	Concentration of each pollutant (mass/liter)

System Output Variables

For system-wide variables, the following output variables can be plotted:

Air Temperature	Degrees (F or C)
Average Loss Rate	Infiltration + evaporation (in/hr or mm/hr)
Direct Inflow	Total direct inflow (cfs or cms)
Dry Weather Inflow	Total dry weather inflow (cfs or cms)
External Inflow	Total external inflow (cfs or cms)
Groundwater Inflow	Total groundwater inflow (cfs or cms)
I & I Inflow	Total RDII inflow and infiltration (cfs or cms)
Nodal Storage Volume	Total nodal storage volume (ft ³ or m ³)
Outfall Outflows	Total outflow from outfalls (cfs or cms)
Rainfall Rate	Total rainfall rate (in/hr or mm/hr)
Runoff Flow	Total runoff flow (cfs or cms)
Snow Depth	Total snow depth (in or mm)
Surface Flooding	Total surface flooding (cfs or cms)

Creating a Time Series Plot

To create a Time Series Plot:

- 1 Choose an element from the Plan View and then right-click and select **DISPLAY TIME SERIES PLOT** as shown in the following figure. Alternatively, click the **TIME SERIES PLOT**  icon from the Output toolbar or choose **OUTPUT > TIME SERIES PLOT**. Or, right-click an element and select **TIME SERIES PLOT** from the displayed context menu.

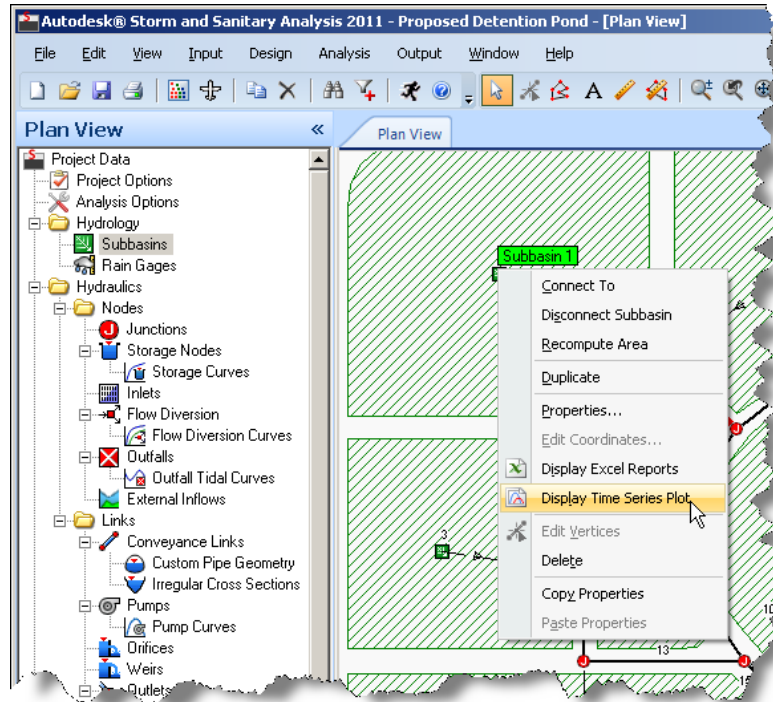

Figure 5.40 To display a Time Series Plot for a particular element, right-click and select Display Time Series Plot

- 2 The Time Series Plot is then displayed, as shown previously in Figure 5.38 on page 140. This plot allows you to select any output variable for any network element using the Output Variable Tree displayed on the left hand side of the plot.

The Output Variable Tree, as shown in the following figure, allows you to select the output variable type for the network element of interest.

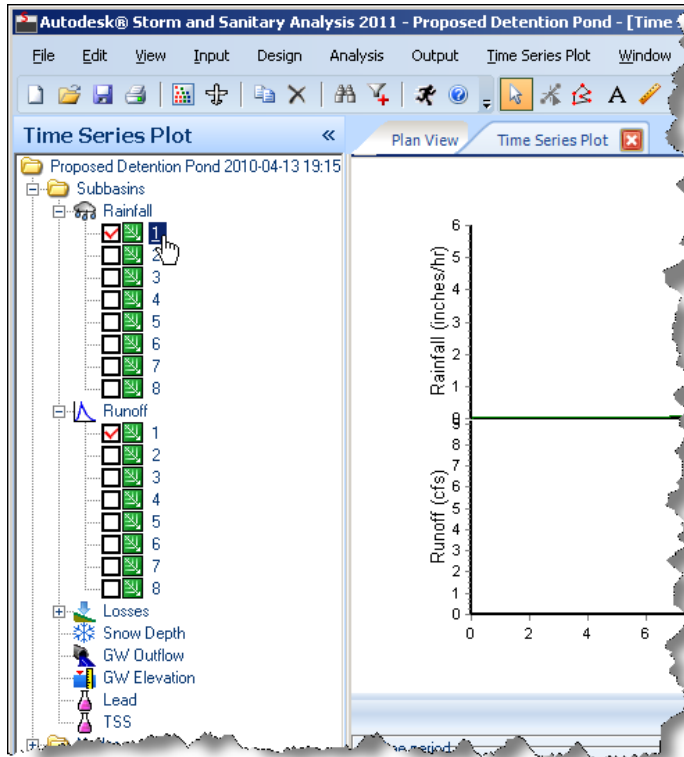

Figure 5.41 The Output Variable Tree allows you to select the output variable type for the network element of interest

- 3 Expand and collapse a particular subcategory within the Output Variable Tree by clicking the category or selecting the **EXPAND** or **COLLAPSE** icons.
- 4 To display the output results for a particular network element, check the box adjacent to the listed element. The Time Series Plot Window is updated with the results.

Displaying Multiple Time Series Plots

Multiple time series plots can be displayed, as shown in the following figure, allowing you to easily compare analysis results for different elements and output properties. Time series plots of the same variable but for different elements of the same element type are superimposed on the same axis. Time series plots of different variables or different element types are plotted on different axes.

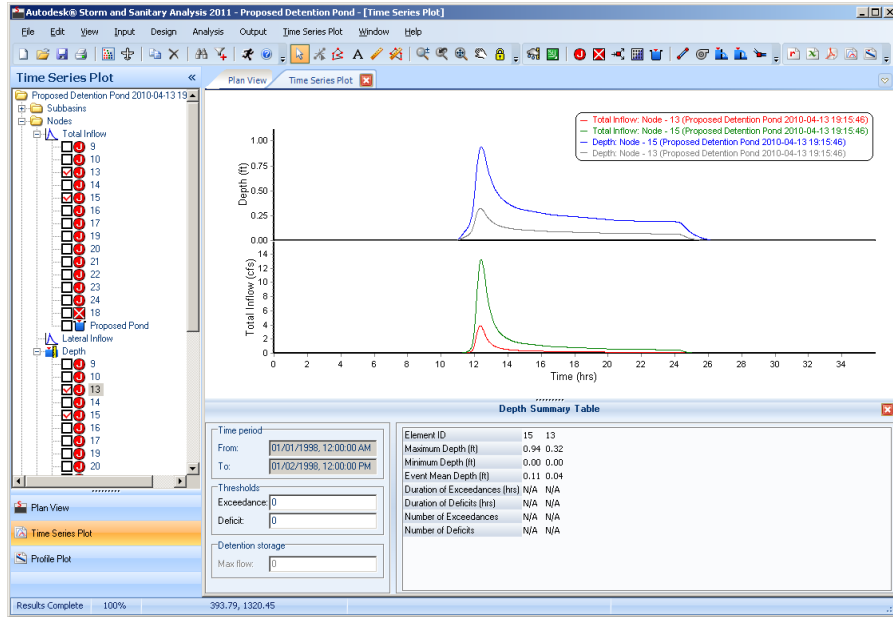

Figure 5.42 Multiple time series plots can be displayed, allowing you to easily compare results for different elements and output properties

Comparing Different Simulation Results

Many times it is necessary to compare analysis output results from different simulation runs, such as comparing pre-development and post-development condition results. The software allows you to graphically compare previously saved simulation results with the current simulation results.

To graphically compare a previously saved simulation with the current simulation:

- 1 From the menu, select **TIME SERIES PLOT** ► **OPEN SOLUTION** as shown in the following figure. Alternatively, right-click in the Output Variable Tree and select **OPEN SOLUTION** from the displayed context menu.

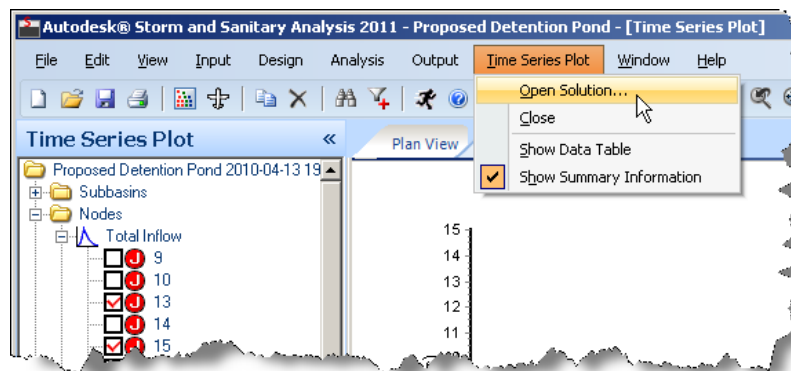

Figure 5.43 To load the results from a previously performed simulation, select Time Series Plot ► Open Solution

- The Open Solution dialog box is then displayed. From this dialog box you can select the solution file to load. Note that the default solution filename contains the filename of the original input file along with a date and time stamp of the simulation run. The date stamp is in the form of **YYYY MM DD** and the time stamp is in the form of **HHMMSS**.

Select the solution file to load and click OK.

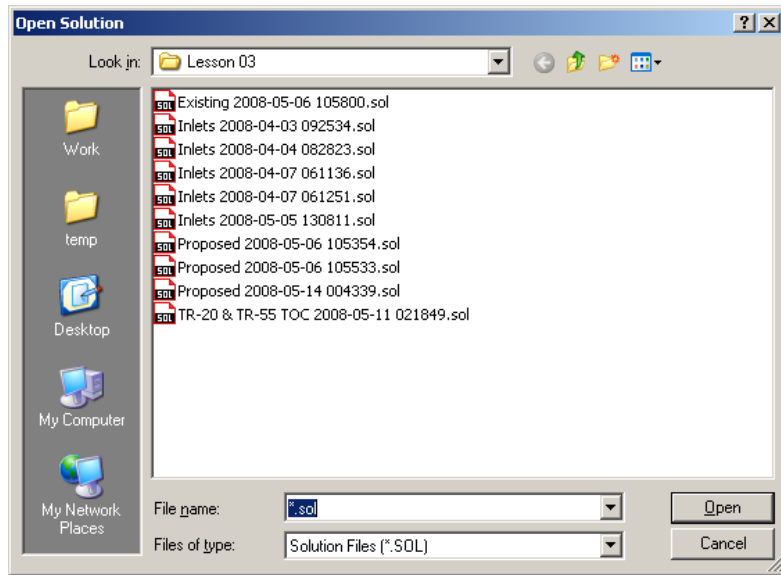

Figure 5.44 Select the solution file to load

- The software will then load the selected solution file. The Output Variable Tree will show both the current simulation results and loaded simulation results. Additional simulation result files can be loaded if desired.

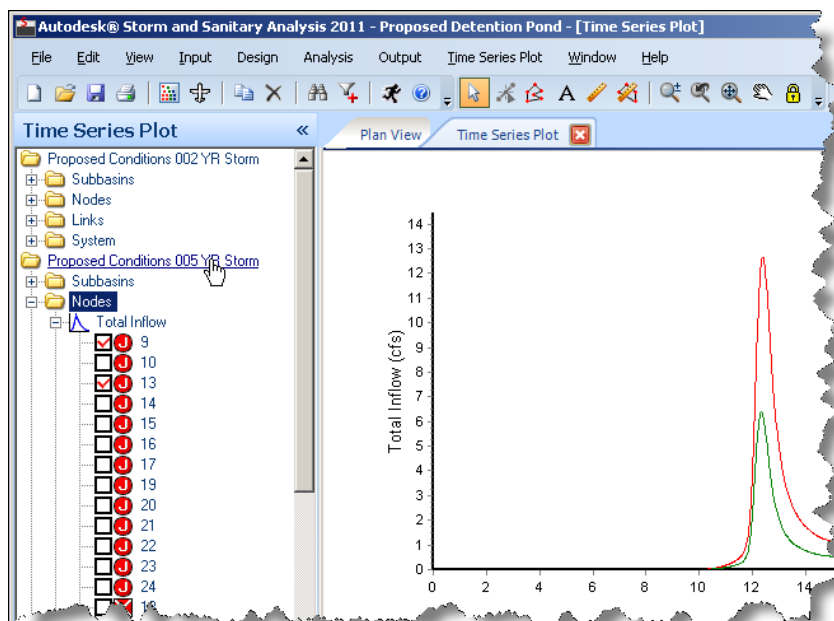

Figure 5.45 The Output Variable Tree will show both the current simulation results and loaded simulation results properties

- 4 To unload a previously loaded simulation result file, position your cursor in the Output Variable Tree over the file to unload, and then right-click and select **CLOSE SIMULATION** from the displayed context menu. The software will then unload the selected simulation results from memory.

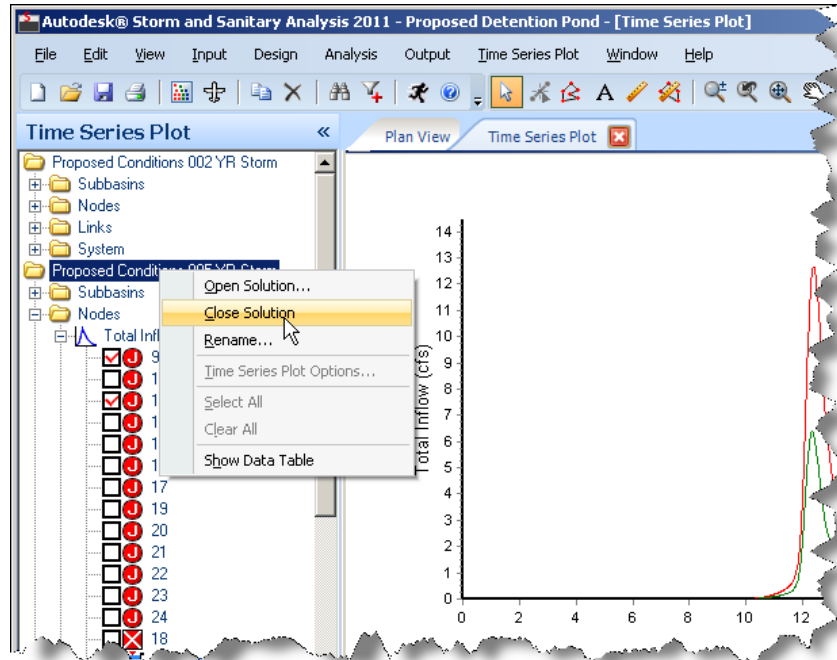

Figure 5.46 To unload a previously loaded simulation results file, right-click it and click Close Simulation

Summary Table Section

As shown in the following figure, the bottom of the graph plot contains a Summary Table section detailing the current selected variable being plotted. This section changes, based upon which element and variable is selected in the Output Variable Tree. To close the Summary Table section, either click the **X** in the upper right hand corner, or right-click and uncheck the **SHOW SUMMARY TABLE** item from the displayed context menu. This will clear the check mark (✓) from in front of the menu item.

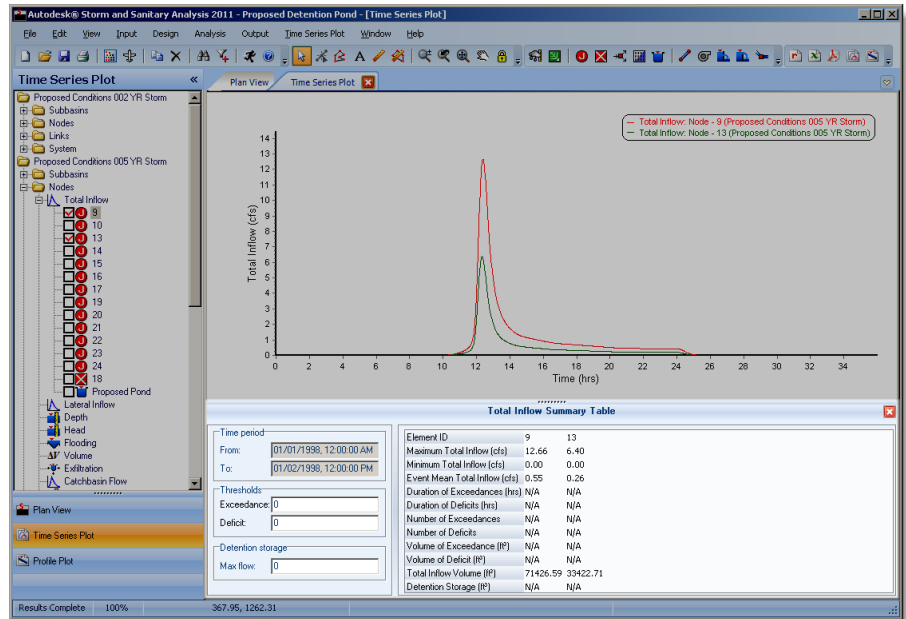

Figure 5.47 The Summary Table section (see highlighted section) details the current selected variable being plotted

The data shown within the Summary Table section can be exported out to Microsoft Excel or Word. Right-click the Summary Table section and select **EXPORT TO EXCEL** or **EXPORT TO WORD** from the displayed context menu.

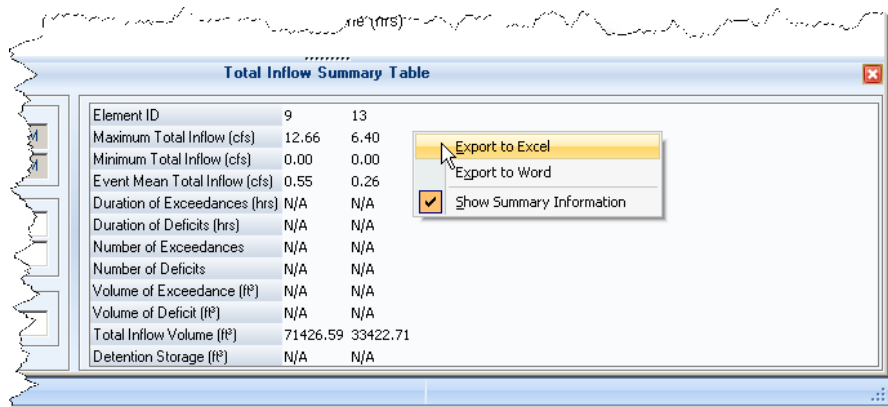

Figure 5.48 The Summary Table section can be exported out to Microsoft Excel or Word

Computing Detention Pond Minimum Storage Volumes

The software can compute the minimum storage volume necessary for a detention pond using the graph plot. By comparing pre-development and post-development conditions, an initial minimum storage volume requirement can be determined for a detention pond.

To compute the minimum storage volume for a pond:

- 1 Using the steps from the section titled *Comparing Different Simulation Results* on page 146, load up the pre-development and post-development analysis results.

- 2 Select and display the **TOTAL INFLOW** for the node where the detention pond is to be located for both pre-development and post-development conditions. The software will display the flow hydrograph for both conditions on top of each other.

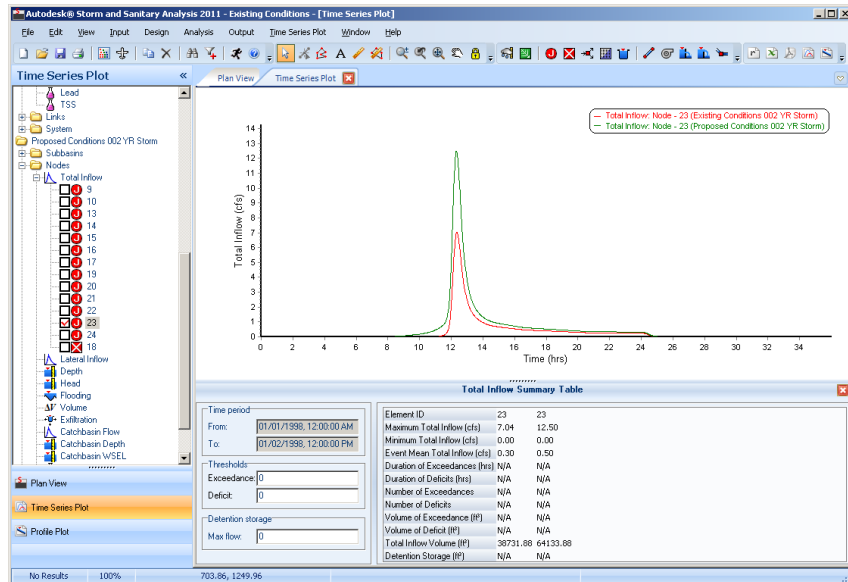

Figure 5.49 Display the flow hydrograph for the node where the detention pond is to be located for both pre-development and post-development conditions

- 3 In the Summary Table section will be listed the **MAXIMUM TOTAL INFLOW** for both pre-development and post-development conditions. These values correspond to the peak flow at the selected node. If the detention pond requirements are that the pond must be sized to capture the post-development conditions peak and reduce this peak to pre-development conditions, then enter the pre-development peak discharge value into the **DETENTION STORAGE MAX FLOW** field.
- 4 An intersect line on the post-development hydrograph is then displayed, corresponding to the entered peak value. The software will also compute the volume between the post-development hydrograph and the intersect line. This volume is displayed as **DETENTION STORAGE** in the Summary Table section and corresponds to the minimum storage volume necessary to capture the peak flow for post-development conditions in order to release this stored water at a lower flow rate.

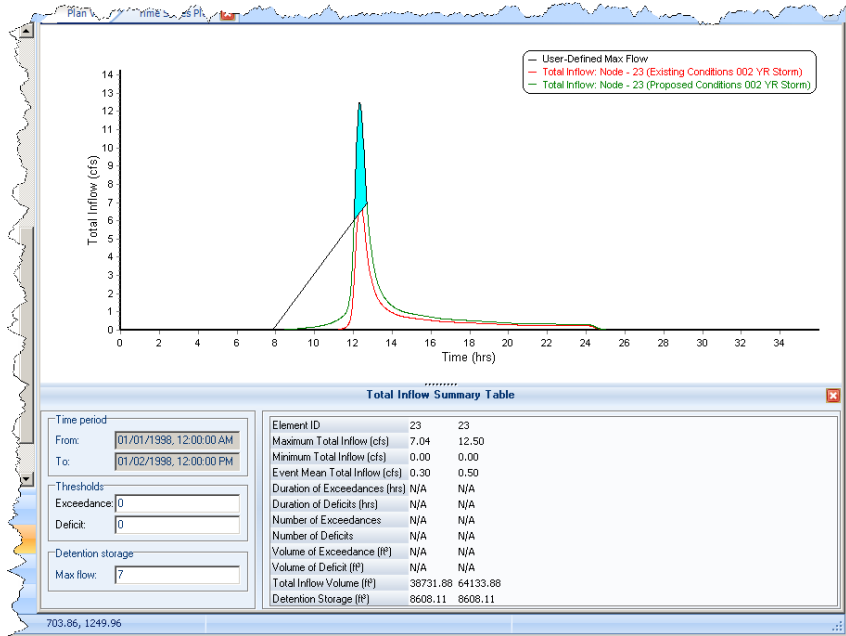

Figure 5.50 The software will display an intersect line for the specified Max Flow, and automatically compute the minimum detention storage volume

- The units that the required storage volume is displayed as can be changed. Right-click the graph plot and select **TIME SERIES PLOT OPTIONS** from the displayed context menu. The software will display the Time Series Plot Options dialog box. From this dialog box you can then select from the **VOLUME** drop-down list the volume units to display the results in.

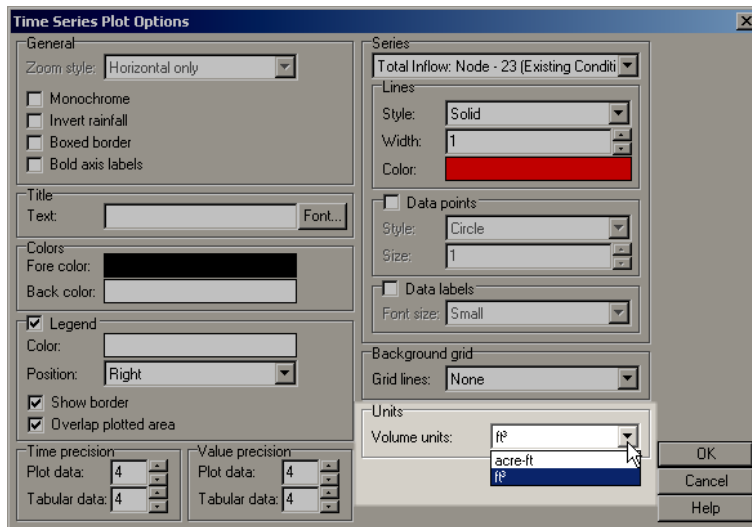

Figure 5.51 The software allows you to change the volume units to display the results as (see highlighted section)

Data Table

As shown in the following figure, an Excel-style Data Table can be displayed at the bottom left corner of the application (below the Output Variable Tree) which lists the time series data values for the currently selected element variable. To display the Data Table, right-click the Output Variable Tree and select **SHOW DATA TABLE**

from the displayed context menu. The Data Table contents change, based upon which element and variable is selected in the Output Variable Tree. To close the Data Table, either click the **X** in the upper right hand corner of the Data Table, or right-click the Data Table and uncheck the **SHOW DATA TABLE** from the displayed context menu. This will clear the check mark (✓) from in front of the menu item.

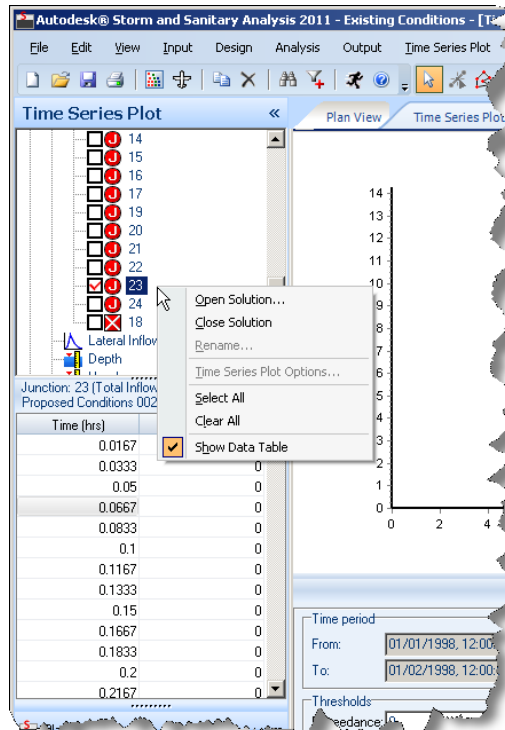

Figure 5.52 An Excel-style Data Table can be displayed which lists the time series data values for the currently selected element variable

The data shown within the Data Table can also be exported to Microsoft Excel. Right-click the Data Table and select **EXPORT TO EXCEL** from the displayed context menu.

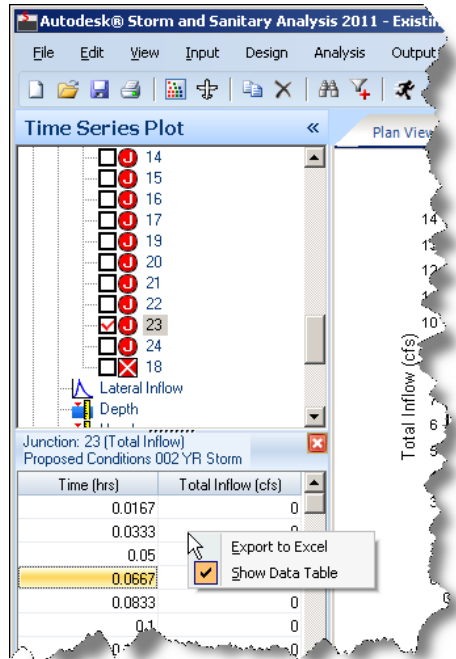

Figure 5.53 The contents contained within the Data Table can be exported to Microsoft Excel

Right-Click Context Menu

The software provides a great deal of additional commands within the Time Series Plot right-click context menu, as shown in the following figure.

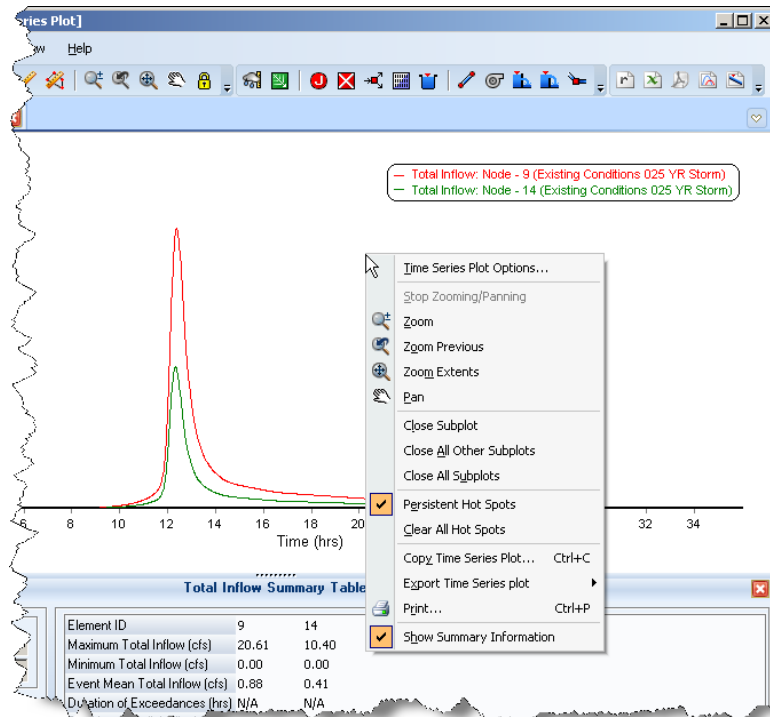

Figure 5.54 Numerous commands are available from the right-click context menu

Time Series Plot Customization

The software allows extensive customization of time series plots. To customize the current time series plot, right-click the displayed time series plot and select **TIME SERIES PLOT OPTIONS** from the displayed context menu. The software will display the Time Series Plot Options dialog box, as shown in the following figure. Make whatever changes you want to the time series plot, and then click OK.

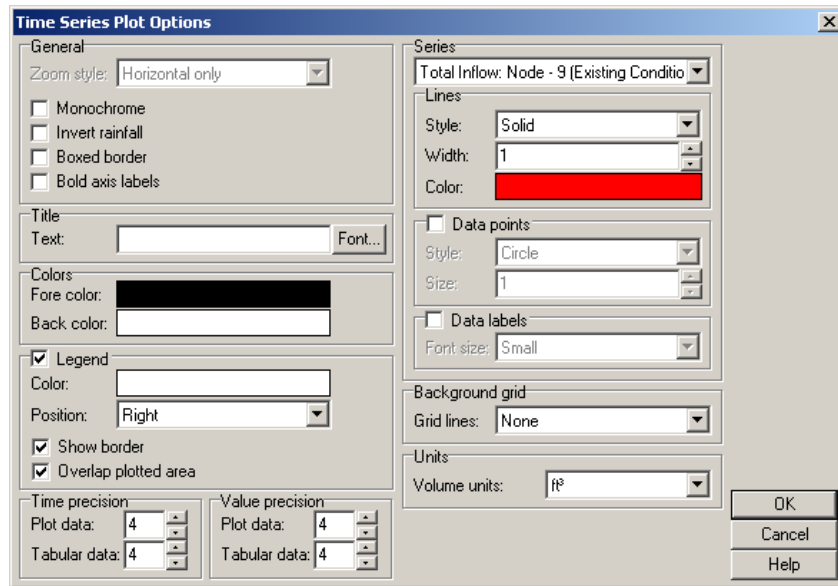

Figure 5.55 Extensive customization of graph plots is available from the Time Series Plot Options dialog box

Legend Location

The software allows you to change the location of the time series plot legend. From the Time Series Plot Options dialog box (as discussed previously), select the desired location of the legend. Alternatively, click and drag the legend on the time series plot to the desired location as shown in the following figure.

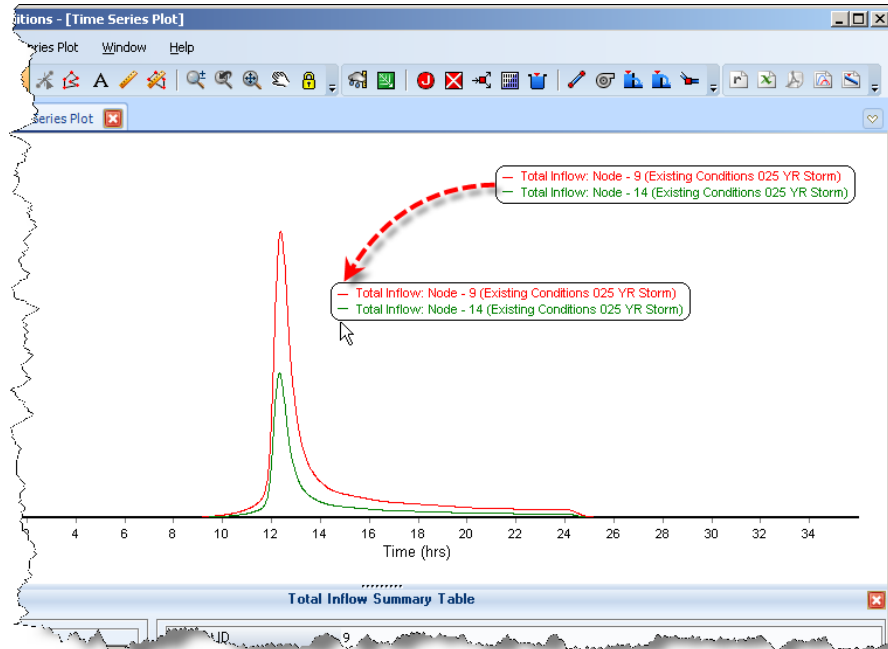



Figure 5.56 Click and drag the legend on the time series plot to the desired location

Zooming and Panning

To zoom in and out on the times series plot and if the mouse has a scroll wheel, scroll the wheel to zoom in and out. Alternatively, use the **ZOOM**  tool and drag a zoom window (with the left mouse button held down) horizontally (left to right or right to left) to zoom in. Hold down the Shift key and click to zoom out. To zoom to the full extents of the time series plot, right-click the plot and select **ZOOM EXTENTS** from the displayed context menu.

To pan the times series plot in any direction and if the mouse has a scroll wheel (or a middle button), hold it down and drag to pan. Alternatively, use the **PAN**  tool and drag with the left mouse button held down to pan.

Printing, Copying, and Exporting

To print the time series plot, right-click the plot and select **PRINT** from the displayed context menu. The Print dialog box is then displayed, allowing you to select the printer and print options you want for printing the time series plot.

To copy the time series plot to the clipboard, right-click and select **COPY**. The time series plot will then be copied to the Microsoft Windows clipboard, allowing you to paste the plot directly into other Windows programs, such as Microsoft Word.

To export the time series plot, right-click and select **EXPORT** and then select the file format to export. The Export dialog box is then displayed, allowing you to define what file format to export the time series plot as.

Automatic Updating of Plots

The current displayed time series plot will automatically update when the analysis is re-run.

Time Series Tables

The software allows you to create time series tables for selected elements and variables, as shown in Figures 5.57 and 5.58.

Time Series Table by Element

Time Series Table by Element tabulates the time series for several variables for a single network element. For example, a time series table can be generated for a channel that correlates flow rate with water depth.

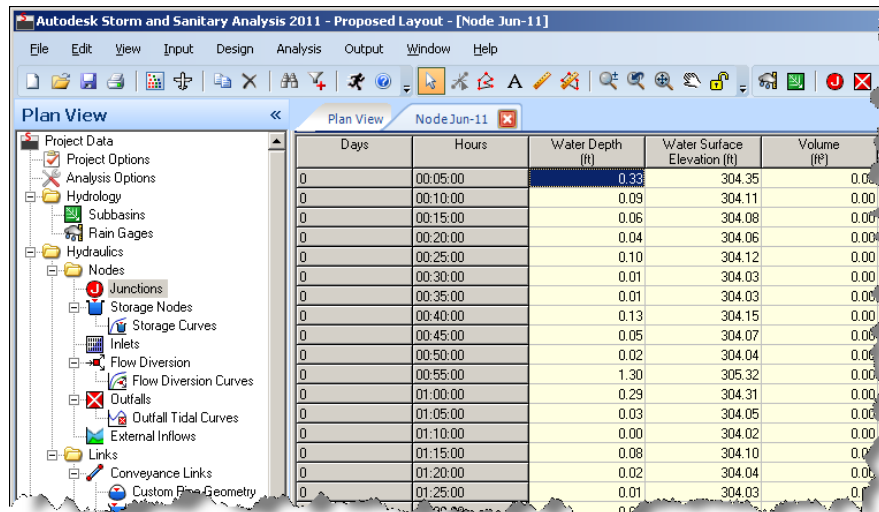

Days	Hours	Water Depth (ft)	Water Surface Elevation (ft)	Volume (ft³)
0	00:05:00	0.33	304.35	0.00
0	00:10:00	0.09	304.11	0.00
0	00:15:00	0.06	304.08	0.00
0	00:20:00	0.04	304.06	0.00
0	00:25:00	0.10	304.12	0.00
0	00:30:00	0.01	304.03	0.00
0	00:35:00	0.01	304.03	0.00
0	00:40:00	0.13	304.15	0.00
0	00:45:00	0.05	304.07	0.00
0	00:50:00	0.02	304.04	0.00
0	00:55:00	1.30	305.32	0.00
0	01:00:00	0.29	304.31	0.00
0	01:05:00	0.03	304.05	0.00
0	01:10:00	0.00	304.02	0.00
0	01:15:00	0.08	304.10	0.00
0	01:20:00	0.02	304.04	0.00
0	01:25:00	0.01	304.03	0.00

Figure 5.57 Time Series Table by Element tabulates the time series results for several variables for a single network element

Time Series Table by Element can be made for many different output variables for the following element types:

- Subbasins
- Nodes
- Links

In addition to generating time series tables for the above network elements, you can generate time series tables for system-wide (network) results.

Time Series Table by Variable

Time Series Table by Variable tabulates the time series for a single variable for several network elements of the same type. For example, a time series table can be generated to show the runoff for several subbasins.

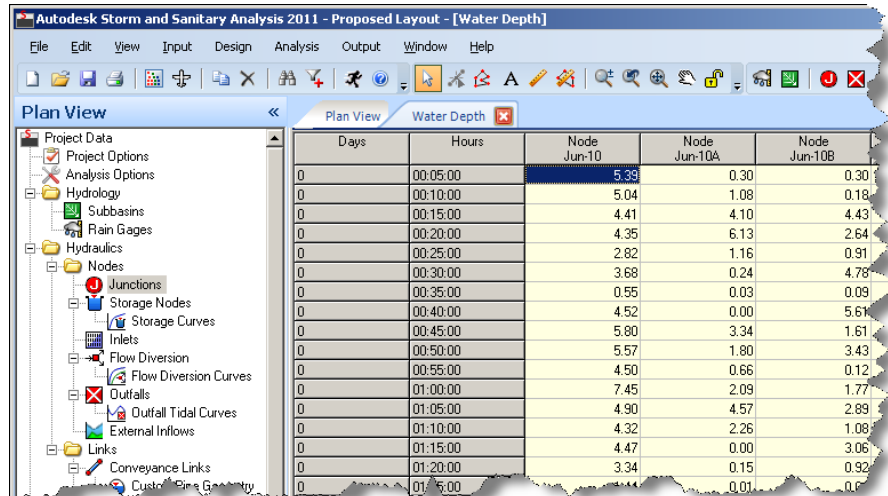

Figure 5.58 Time Series Table by Variable tabulates the time series results for a single variable for several network elements of the same type

By default, the software will select all the elements of the specified type when choosing a Time Series Table by Variable. As shown in the following figure, the Time Series Table by Variable dialog box has a drop-down list that allows you to select the type of element to select. For example, under the **ELEMENT CATEGORY** drop-down list, you can select the main category of element to select (i.e., Subbasins, Nodes, Links). Then, depending upon the main category that is selected, you can further refine this to particular type within this main category, such as Storage Nodes.

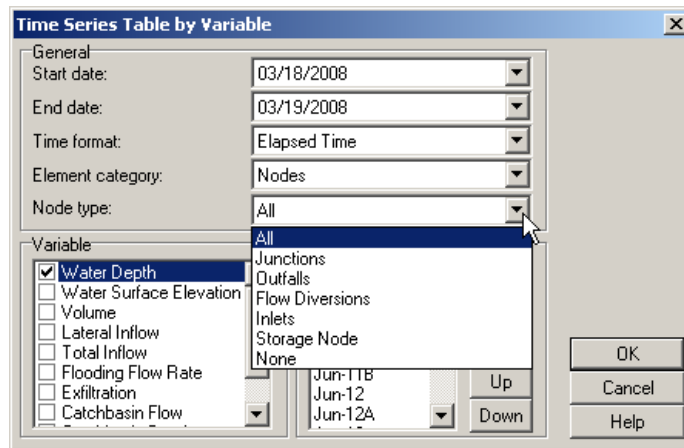

Figure 5.59 Time Series Table by Variable tabulates the time series results for a single variable for several network elements of the same type

Creating a Time Series Table by Element

To create a Time Series Table by Element:

- 1 Choose **OUTPUT ► TIME SERIES TABLE BY ELEMENT**.
- 2 The Time Series Table by Element dialog box is then displayed, as shown in the following figure. This dialog box is used to select the element, output variables, and the time period for which the time series table is to be generated for.

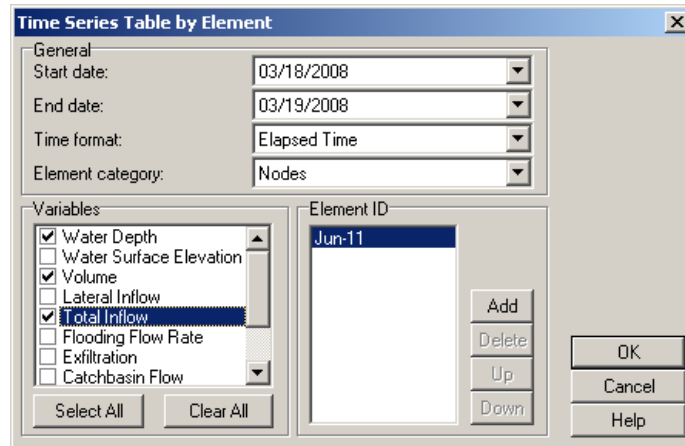

Figure 5.60 The Time Series Table by Element dialog box allows you to select the element, output variables, and the time period for which the time series table is to be generated for

- 3 From the **CATEGORY** drop-down list, select the element type that you want to generate a time series table for.
- 4 From the Plan View, select the network element that you want to generate a time series table for by clicking it, and then clicking the Add button. You can only select one network element.
- 5 From the **VARIABLES** list, select the variables that you want to report. You can select any number of variables to be reported.
- 6 Select a **START DATE** and **END DATE** for the time series table. The default is to use the entire analysis period.
- 7 From the radio button, select to show time reported as **ELAPSED TIME** or **DATE TIME** values.
- 8 Click OK and the time series table is then displayed, similar to what is shown in Figure 5.57 on page 156.

Creating a Time Series Table by Variable

To create a Time Series Table by Variable:

- 1 Choose **OUTPUT ► TIME SERIES TABLE BY VARIABLE**.
- 2 The Time Series Table by Variable dialog box is then displayed, as shown in the following figure. This dialog box is used to select the element, output variables, and the time period for which the time series table is to be generated for.

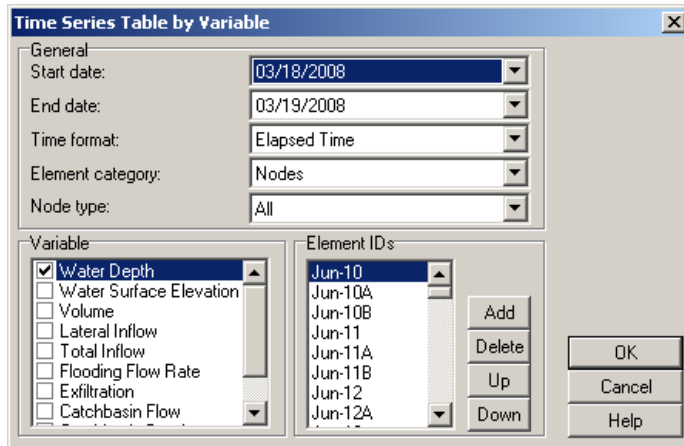

Figure 5.61 The Time Series Table by Variable dialog box allows you to select the output variable, multiple elements of the same type, and the time period for which the time series table is to be generated for

- 3 From the **CATEGORY** drop-down list, select the element type that you want to generate a time series table for.
- 4 From the **VARIABLES** list, select the variable that you want to report. You can only select one variable.
- 5 From the Plan View, select the network elements that you want to generate a time series table for by clicking them, and then clicking the Add button. You can select up to six network elements of the same type to be reported.
- 6 Select a **START DATE** and **END DATE** for the time series table. The default is to use the entire analysis period.
- 7 From the radio button, select to show time reported as **ELAPSED TIME** or **DATE TIME** values.
- 8 Click OK and the time series table is then displayed, similar to what is shown in Figure 5.58 on page 157.

Printing, Copying, and Exporting

To print the time series table that the software generates, right-click the table and select **PRINT** from the displayed context menu. The Print dialog box is then displayed, allowing you to select the printer and print options you want for printing the table.



To copy the time series table, right-click and select **COPY**. The table will then be copied to the Microsoft Windows clipboard, allowing you to paste the table directly into other Windows programs, such as Microsoft Excel. Note, however, that Excel has a limitation of 256 columns. Therefore, if the time series table you copy has more than 256 columns, Excel will only take the first 256 columns of data.

To export the time series table, right-click and select **EXPORT**. The Export dialog box is then displayed, allowing you to define what file format to export the table as.

Automatic Updating of Tables

All tables that are currently displayed will automatically update when a new analysis is run. To prevent a particular table from updating (such as when comparing different conditions), right-click and uncheck the **AUTOMATIC UPDATE** option from the displayed context menu. This will clear the check mark (✓) from in front of the menu item.

Checking this option will again allow the table to automatically update the next time the analysis is run.

Statistical Reports

The software provides statistical reporting by analyzing the model results for a selected network element and output variable. A sample statistical report is shown in the following figure.

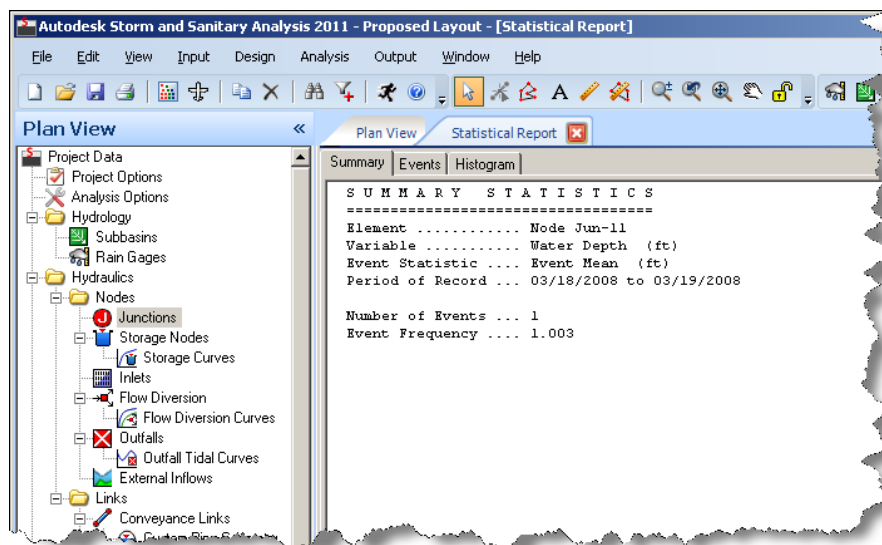

Figure 5.62 Statistical reporting by analyzing the model results for a selected network element and output variable

For a selected network element and output variable, the statistical report will provide the following:

- 1 Segregate the analysis period into a sequence of non-overlapping events, either by:
 - Day
 - Month
 - Flow volume above a specified minimum threshold value
- 2 Compute the following statistical values for the event's time period that characterizes the event:
 - Mean value of the variable
 - Maximum value of the variable
 - Total sum of the variable

3 Compute summary statistics for the entire set of event values:

- Mean
- Standard deviation
- Skewness

4 Perform a frequency analysis on the set of event values.

The frequency analysis of event values will determine the frequency at which a particular event value has occurred and will also estimate a return period for each event value. Statistical analyses of this type are most suitable for long-term continuous analysis runs.

Creating a Statistics Report

To create a statistics report:

- 1 Choose **OUTPUT ► STATISTICAL REPORT**.
- 2 The Statistical Report dialog box is then displayed, as shown in the following figure. This dialog box is used to select the element, output variable, statistics, and event thresholds for which the statistics are to be analyzed for.

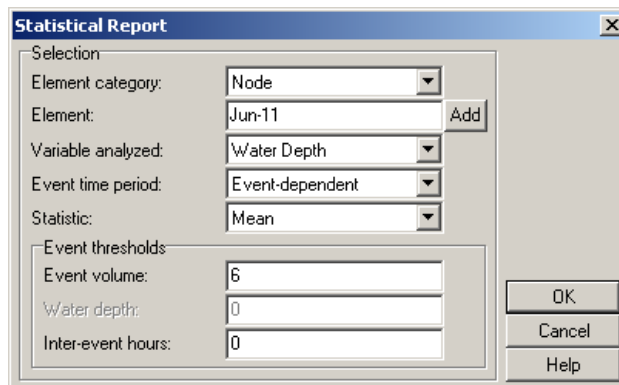

Figure 5.63 The Statistics Report dialog box allows you to select the element, output variable, statistics, and event thresholds for which the statistics are to be analyzed for

3 From the **CATEGORY** drop-down list, select the element type that you want to generate statistics for. The following elements are supported:

- Subbasins
- Nodes
- Links

In addition to generating statistical analysis for the above network elements, you can generate statistical analysis for system-wide (network) results.

- 4 If performing a system-wide statistical analysis, then you do not select a network element. Otherwise, from the Plan View select the network element that you want to perform a statistical analysis for by clicking it, and then clicking the Add button. You can only select one network element.
- 5 From the **VARIABLES** drop-down list, select the variable that you want to analyze. You can only select one variable.

- 6 From the **EVENT TIME PERIOD** drop-down list, select the length of the time period that defines an event. The choices are:
 - Daily
 - Monthly
 - Event-dependent

For event-dependent time periods, the event period depends on the number of consecutive reporting periods where the analysis results are above the specified thresholds, defined below.

- 7 From the **EVENT STATISTICS** drop-down list, select the statistics to be computed. The available statistics depend on the variable being analyzed, and include:
 - Mean value
 - Peak value
 - Event total
 - Event duration
 - Time between events

For water quality, the following statistics are available:

- Mean concentration
- Peak concentration
- Mean loading
- Peak loading
- Event total load

- 8 The **ANALYSIS VARIABLE THRESHOLD** defines the minimum value of the variable being analyzed that must be exceeded for a time period to be considered included in an event.
- 9 The **EVENT VOLUME THRESHOLD** defines the minimum flow volume (or rainfall volume) that must be exceeded for results to be counted as part of an event. A value of 0 represents that a no volume threshold applies.
- 10 The **INTER-EVENT HOURS** defines the minimum number of hours that must occur between two separate events. Events with fewer hours are combined together. This value applies only to event-dependent time periods (not to daily or monthly event periods).
- 11 Click OK and a three tabbed statistical report dialog box is displayed, detailing the following:
 - Table of event summary statistics
 - Table of rank-ordered event periods, including their date, duration, and magnitude
 - Histogram plot of the chosen event statistic

General Data

6

This chapter describes the general input data used to define a stormwater or sanitary (wastewater) sewer model.

Project Description

The Project Description dialog box, shown in the following figure, is used to define general information about the stormwater or wastewater project being analyzed. Select **INPUT ► PROJECT DESCRIPTION** to display the Project Description dialog box.

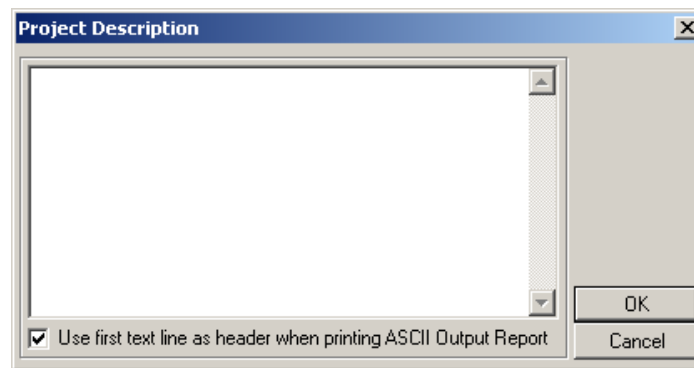



Figure 6.1 The Project Description dialog box

The Project Description dialog box contains a multi-line edit field where a description of a project can be entered. It also contains a check box used to indicate whether or not the first line of text should be used as a header when printing the ASCII analysis output.

Project Options

The Project Options dialog box, shown in Figures 6.2, 6.7, and 6.8, is used to define general options for the stormwater or wastewater project being analyzed. Select **INPUT ► PROJECT OPTIONS** or double-click the **PROJECT OPTIONS**  icon from the data tree to display the Project Options dialog box.

The Project Options dialog box contains a tabbed interface, allowing you to specify various model settings and define element prototypes within the same dialog box. Click the tab of interest to see the data defined within the tabbed pane.

General

The General tabbed pane of the Project Options dialog box is used to define the flow units, infiltration method, routing method, and other numerical options to be used for the model being defined.

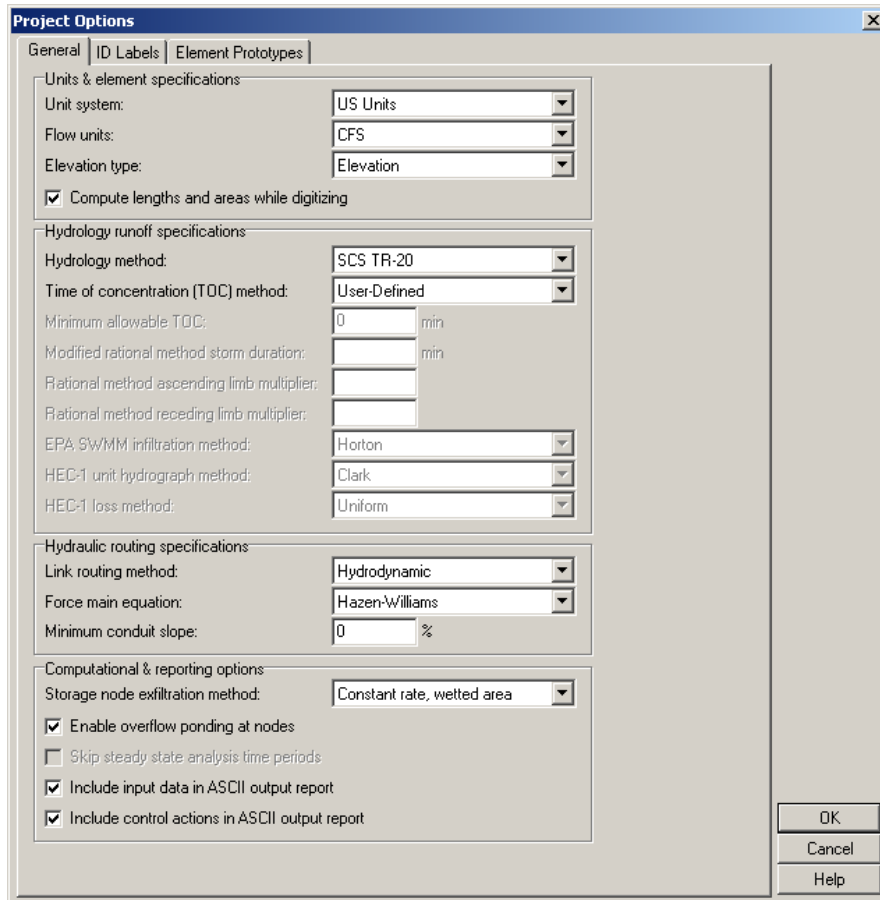

Figure 6.2 The Project Options dialog box, General tabbed pane

The following options are available in the General tabbed pane of the Project Options dialog box.

Units & Element Specifications

The Units & Element Specifications section allows you to define the unit base, flow units and other network specifications. These specifications are defined below.

Unit System

This drop-down list allows you to select the unit system (i.e., US units or SI metric units) to use for both input and output data. Based upon whether US units or SI metric units have been selected, the following units will then be used for defining data.

Data	US Units	Metric (SI) Units
Area (Storage Node)	ft ²	m ²
Area (Ponding)	ft ²	m ²
Area (Subbasins)	acres ft ²	hectares m ²
Capillary Suction	inches	mm
Concentration	mg/L ug/L Counts/L	mg/L ug/L Counts/L
Decay Constant (Infiltration)	1/hours	1/hours
Decay Constant (Pollutants)	1/days	1/days
Depression Depth	inches	mm
Depth	feet	meters
Diameter	inches feet	millimeters centimeters meters
Discharge Coefficient (Orifice)	dimensionless	dimensionless
Discharge Coefficient (Weir)	dimensionless	dimensionless
Elevation	feet	meters
Evaporation	inches/day	mm/day
Flow	CFS GPM MGD	CMS LPS MLD
Head	feet	meters
Hydraulic Conductivity	inches/hour	mm/hour
Infiltration Rate	inches/hour	mm/hour
Length	feet	meters
Manning's n		
Pollutant Buildup	mass/acre mass/length	mass/ha mass/length
Rainfall Intensity	inches/hour	mm/hour
Rainfall Volume	inches	mm
Slope (Conveyance Links)	rise/run	rise/run
Slope (Subbasins)	percent	percent
Slope (Cross Section)	rise/run	rise/run
Street Cleaning Interval	days	days
Volume	cubic feet	cubic meters
Width	feet	meters



If the unit system is changed mid-way through defining a model, previously entered data are not adjusted to account for this change.

Flow Units

This drop-down list allows you to select the flow units to use for both input and output data. The following flow units are available:

US Units

- CFS (cubic feet per second)
- GPM (gallons per minute)
- MGD (million gallons per day)

SI Metric Units

- CMS (cubic meters per second)
- LPS (liters per second)
- MLD (million liters per day)

Typically, GPM and MGD (and LPS and MLD for SI metric) flow units are used when performing sanitary sewer modeling and CFS (and CMS for SI metric) flow units are used when performing stormwater sewer modeling.

If the flow units are changed mid-way through defining a model, previously entered data are not adjusted to account for this change.

Elevation Type

This drop-down list allows you to work in either elevation or depth mode. Working in elevation mode causes all input data to be entered as elevations (e.g., pipe inlet invert elevation). Working in depth mode causes some input data to be entered as a depth offset from the element invert (e.g., pipe inlet invert offset). Elevation is the default mode.

Compute Lengths and Areas While Digitizing

Check this option to have the software use the Plan View coordinate system to compute lengths and areas when digitizing channels, pipes, and subbasins on top of a background image.

Hydrology Runoff Specifications

The Hydrology Runoff Specifications section allows you to define the hydrology parameters to use in defining the model. These parameters are defined below.

Hydrology Method

This drop-down list allows you to select the hydrology method to use to model subbasin runoff.

The following different hydrology methods are provided:

- DeKalb Rational Method
- EPA SWMM
- Modified Rational Method
- Rational Method
- Santa Barbara Unit Hydrograph (SBUH) Method
- SCS TR-20
- SCS TR-55
- US Army Corps HEC-1

Changing the hydrology method mid-way through defining a model may require re-entering some values for the hydrology runoff parameters for each subbasin.

If continuous simulation, pollutants, groundwater, or snowmelt is to be simulated, then the EPA SWMM hydrology method must be used.



Time of Concentration (TOC) Method

This drop-down list allows you to select the time of concentration (Tc) method to use to model subbasin runoff.

The following Tc methods are provided:

- Carter
- Eagleson
- FAA
- Harris County, TX
- Kirpich
- Papadakis-Kazan (Maricopa & Pima Counties, AZ)
- SCS TR-55
- User-defined

Note that selection of these different Tc methods are only available if the EPA SWMM subbasin hydrology method is not selected. If the EPA SWMM subbasin hydrology method is selected, then the Tc is computed by the Kinematic Wave method and cannot be changed.

Generally the Tc method to use is specified by local review agencies. Therefore, refer to local agency design procedures to determine the appropriate Tc method to select.

Changing the Tc method mid-way through defining a model will require re-entering values for the Tc parameters for each subbasin. However, if desired, you can override, on a subbasin-by-subbasin basis, the Tc that is computed with a user-defined Tc. See the **TIME OF CONCENTRATION** entry in the Subbasins dialog box, on page 324 for more information.

Minimum Allowable TOC (optional)

This field allows you to specify the minimum time of concentration (Tc) to prevent high runoff estimates for small subbasins. This value will override the computed Tc if the computed Tc is less than the specified minimum Tc. For example, if the computed Tc for a subbasin is 2:43 (2 minutes and 43 seconds) and a minimum allowable Tc of 5 minutes is specified, the software will use 5 minutes as the Tc for the subbasin.

Note that this field is not applicable if the EPA SWMM subbasin hydrology method is selected.

Modified Rational Method Storm Duration

This field allows you to specify the storm duration when using the Modified Rational hydrology method. This value is required and is generally at least 2 times the maximum time of concentration.

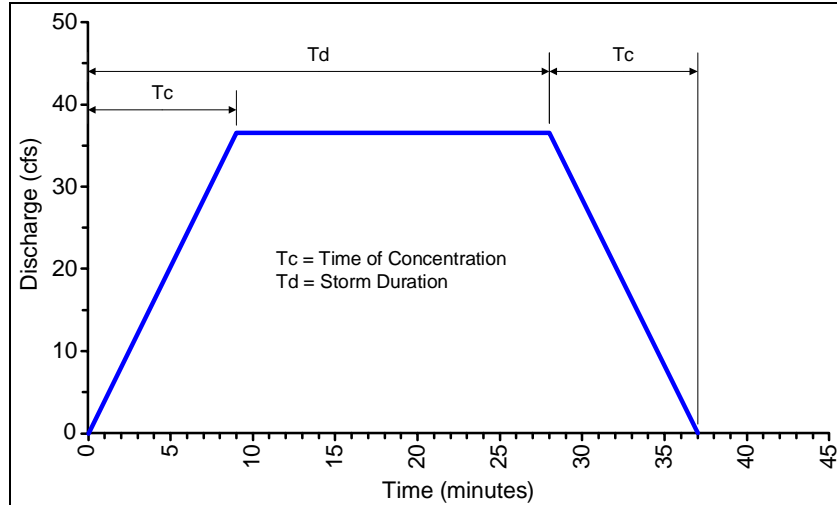

Figure 6.3 How the Storm Duration defines the Modified Rational Method computed hydrograph

Rational Method Ascending Limb Multiplier

This value stretches (or shortens) the ascending limb of the computed triangular hydrograph when using the Rational hydrology method. The ascending limb of the runoff hydrograph occurs over the time duration obtained by multiplying this multiplier by the computed time of concentration (T_c). Therefore, the ascending limb is equal to $T_c \times$ Ascending Limb Multiplier. For example, if the Ascending Limb Multiplier is specified as 0.8, then the ascending side of the hydrograph would be $0.8 \times T_c$.

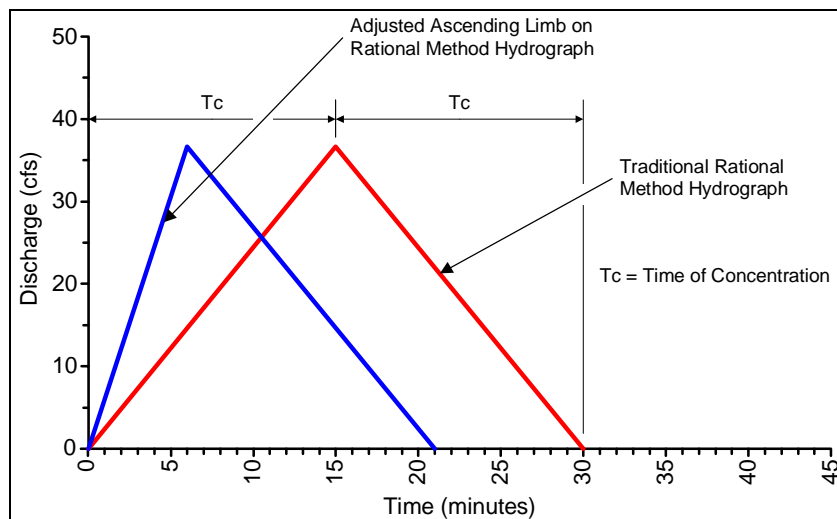

Figure 6.4 How the Ascending Limb Multiplier affects the Rational Method computed triangular hydrograph

By shortening the ascending limb of the Rational Method's triangular hydrograph, the hydrograph shape more closely resembles that of a true hydrograph. However, the resulting runoff volume thereby decreases from the rainfall that contributes to the hydrograph, making the method non-conservative (less safe).

The default value is 1.0. Refer to local agency design procedures to determine the appropriate ascending limb multiplier to use.

Rational Method Receding Limb Multiplier

This value stretches (or shortens) the receding limb of the computed triangular hydrograph when using the Rational hydrology method. The receding limb of the runoff hydrograph occurs over the time duration obtained by multiplying this multiplier by the computed time of concentration (T_c). Therefore, the receding limb is equal to $T_c \times$ Receding Limb Multiplier. For example, if the Receding Limb Multiplier is specified as 1.4, then the receding side of the hydrograph would be $1.4 \times T_c$.

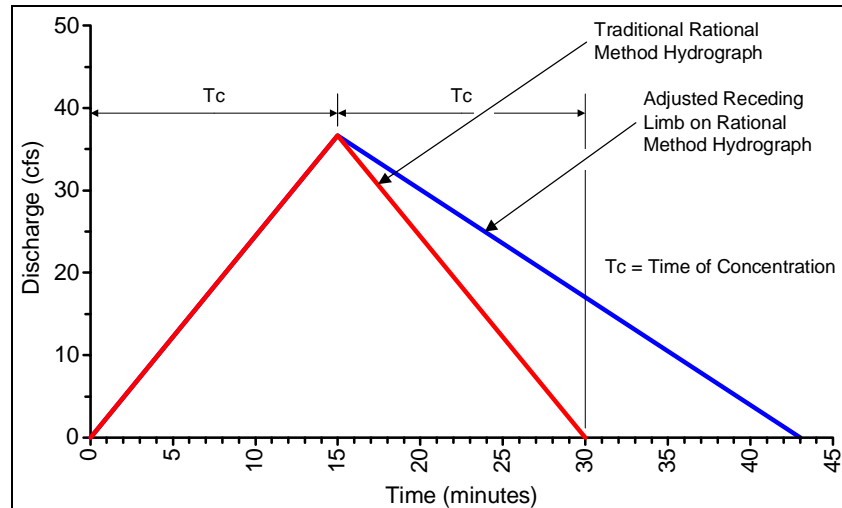

Figure 6.5 How the Receding Limb Multiplier affects the Rational Method computed triangular hydrograph

By stretching the receding limb of the Rational Method's triangular hydrograph, the hydrograph shape more closely resembles that of a true hydrograph. The resulting runoff volume also increases in excess to the rainfall that contributes to the hydrograph, adding a conservative safety factor to the method.

The default value is 1.0. Refer to local agency design procedures to determine the appropriate receding limb multiplier to use.

EPA SWMM Infiltration Method

This drop-down list allows you to select the infiltration method to use when the EPA SWMM hydrology method is selected.

Although infiltration parameters are specified on a subbasin by subbasin basis, only one infiltration method can be selected for the model simulation. Three different infiltration methods are provided:

- SCS Curve Number
- Horton
- Green-Ampt

Changing the infiltration method mid-way through defining a model may require re-entering values for the infiltration parameters for each subbasin.

SCS Curve Number Infiltration (default method)

This infiltration method is adapted from the NRCS (SCS) Curve Number method for estimating runoff. It assumes that the total infiltration capacity of a soil can be found from the soil's tabulated Curve Number. During a rain

event this capacity is depleted as a function of cumulative rainfall and remaining capacity. The input parameters for this method are the curve number, the soil's hydraulic conductivity (used to estimate a minimum separation time for distinct rain events), and a time it takes a fully saturated soil to completely dry.

The key advantages and limitations of the Curve Number infiltration method include:

- The Curve Number infiltration method continues to be most satisfactory when used for the type of hydrologic problem that it was developed to solve—evaluating effects of land use changes and conservation practices on direct runoff.
- The Curve Number infiltration method is less accurate when runoff is less than 0.5 inches.
- When the weighted curve number is less than 40, use another infiltration method to determine runoff.
- The Curve Number infiltration method is well established and widely accepted for use in the USA and abroad.
- Can be used for forested areas.
- Infiltration rate will approach zero during a storm of long duration, rather than constant rate as expected.
- Default initial abstraction (0.2S) does not depend upon storm characteristics or timing.
- Rainfall intensity not considered—same infiltration loss for 1 inch of rainfall in 1 hour or 1 day.
- Runoff from snow melt or rain on frozen ground cannot be estimated using the Curve Number infiltration method.

Horton Infiltration

This infiltration method is based on empirical observations showing that infiltration decreases exponentially from an initial maximum rate to some minimum rate over the course of a long rainfall event. Input parameters required by this method include the maximum and minimum infiltration rates, a decay coefficient that describes how fast the rate decreases over time, and a time it takes a fully saturated soil to completely dry.

The key advantages and limitations of the Horton infiltration method include:

- The Horton infiltration method is most likely to be important in urban and agricultural areas where the infiltration capacity of soils is relatively small due to cultural activities.
- Because overland flow rarely occurs in forested soils, the Horton infiltration method is not applicable to these areas.

Green-Ampt Infiltration

This infiltration method assumes that a sharp wetting front exists in the soil column, separating soil with some initial moisture content below from saturated soil above. The input parameters required are the initial moisture deficit of the soil, the soil's hydraulic conductivity, and the suction head at the wetting front.

The key advantages and limitations of the Green-Ampt infiltration method include:

- The parameters of the Green-Ampt infiltration method can be related to soil properties that can be measured in the laboratory, such as porosity and hydraulic conductivity.
- The Green-Ampt infiltration method assumes an overland flow type mechanism which is not entirely appropriate for forested areas where a subsurface mechanism tends to control direct runoff.

HEC-1 Unit Hydrograph Method

This drop-down list allows you to select the HEC-1 subbasin runoff unit hydrograph method to use. The unit hydrograph method computes the hydrologic runoff response after infiltration has been computed using a loss method. The following unit hydrograph methods are provided:

- Clark (default)
- Kinematic Wave
- SCS Dimensionless
- Snyder
- User Defined UH

Changing the unit hydrograph method mid-way through defining a model may require re-entering some values for the hydrology parameters for each subbasin.

Clark (default method)

The Clark unit hydrograph method is the default unit hydrograph method for HEC-1. The Clark unit hydrograph method is a synthetic unit hydrograph method. That is, you are not required to develop a unit hydrograph through the analysis of past observed hydrographs.

The Clark unit hydrograph method derives a watershed unit hydrograph by explicitly representing two critical processes in the transformation of excess precipitation to runoff:

- Translation or movement of the excess from its origin throughout the drainage to the watershed outlet.
- Attenuation or reduction of the magnitude of the discharge as the excess is stored throughout the watershed.

Kinematic Wave

As an alternative to the listed synthetic unit hydrograph methods, HEC-1 includes a conceptual Kinematic Wave Method for modeling the subbasin runoff response. The Kinematic Wave Method represents the subbasin as an open channel (a very wide, open channel), with inflow to the channel equal to the excess precipitation. It then solves the equations that simulate unsteady shallow water flow in an open channel to determine the subbasin runoff hydrograph.

The Kinematic Wave method is principally used for representing urban areas, although it can be used for undeveloped regions as well. It is a conceptual model that includes one or two representative overland flow planes. Typically, one overland flow plane is used for pervious areas and the other plane for

impervious areas. The same meteorological boundary conditions are applied to each plane. However, separate loss rate information is required for each plane and is entered separately as part of the loss method.

SCS Dimensionless

The Soil Conservation Service (SCS) dimensionless unit hydrograph procedure is one of the most well known methods for deriving synthetic unit hydrographs in use today. *(Note that the SCS agency is now known as the Natural Resources Conservation Service or NRCS, but the acronym SCS is still used in association with its unit hydrograph and time of concentration methods.)*

The SCS unit hydrograph method was originally developed from observed data collected in small, agricultural watersheds from across the country. This data were generalized as a dimensionless unit hydrograph which can be scaled by time lag to produce the unit hydrograph for use. It is interesting to note that 37.5% of the runoff volume occurs before the peak flow and the time base of the hydrograph is five times the lag.

Snyder

The Snyder Unit Hydrograph method was developed for Appalachian area watersheds ranging from 10 to 10,000 square miles. This method has been successfully applied to watersheds across the United States by the US Army Corps of Engineers. The Snyder Unit Hydrograph method provides a means of generating a synthetic unit hydrograph by calculating the lag time, peak flow, and total time base through two relationships involving drainage area, length measurements, and estimated parameters. Because the Snyder method does not directly define the final hydrograph shape, the HEC-1 implementation of the Snyder method utilizes a unit hydrograph generated with the Clark method such that the empirical Snyder relationships are maintained.

User Defined UH

The User Defined Unit Hydrograph method can be used to match observed runoff flows from a specific historical event, or it can be from a hypothetical storm.

HEC-1 Loss Method

This drop-down list allows you to select the loss method to use to model HEC-1 subbasin runoff. The following loss methods are provided:

- Exponential
- Green Ampt
- Holtan
- SCS Curve Number
- Uniform (default)

Changing the loss method mid-way through defining a model may require re-entering some values for the hydrology parameters for each subbasin.

Exponential

The Exponential Loss Method is empirical and typically should not be used without calibration. It represents incremental infiltration as logarithmically decreasing with accumulated infiltration. It includes the option for increased initial infiltration when the soil is particularly dry before the arrival of a storm. Because it is a function of cumulative infiltration and does not include any type of recovery, it should not be used for continuous simulation studies.

Green Ampt

The Green Ampt Loss Method assumes the soil is initially at a uniform moisture content, and infiltration takes place through a sharp wetting front. This wetting front exists in the soil column, separating soil with an initial moisture content below from saturated soil above. This method automatically accounts for ponding on the surface.

The key advantages and limitations of the Green-Ampt infiltration method include:

- The parameters of the Green-Ampt infiltration method can be related to soil properties that can be measured in the laboratory, such as porosity and hydraulic conductivity.
- The Green-Ampt infiltration method assumes an overland flow type mechanism which is not entirely appropriate for forested areas where a subsurface mechanism tends to control direct runoff.

Holtan

The Holtan Loss Method was developed for agricultural watersheds. Infiltration is treated as a function of crop maturity, surface connected porosity, available storage in the surface layer, and soil infiltration rate.

SCS Curve Number

The SCS Curve Number Loss Method is a commonly used loss method for HEC-1. The SCS Curve Number Loss Method is adapted from the NRCS (SCS) Curve Number method for estimating runoff. It assumes that the total infiltration capacity of a soil can be found from the soil's tabulated Curve Number. During a rain event this capacity is depleted as a function of cumulative rainfall and remaining capacity. The input parameters for this method are the curve number, the soil's hydraulic conductivity (used to estimate a minimum separation time for distinct rain events), and a time it takes a fully saturated soil to completely dry. For more background information regarding this method, see page 169.

Uniform (default method)

The Uniform Loss Method is the default loss method for HEC-1. The Uniform Loss Method is simple in concept, but is generally appropriate for watersheds that lack detailed soil infiltration information. For this method, an initial loss and a constant loss rate are specified.

The initial loss specifies the amount of initial precipitation that will be infiltrated (or stored) in the subbasin before surface runoff begins. All initial rainfall is lost until the specified initial loss volume is satisfied. There is no recovery of the initial loss during later time periods without precipitation.

The constant rate specifies the rate of infiltration that will occur after the initial loss is satisfied. After the initial loss is satisfied, rainfall is lost at the specified constant loss rate. The same rate is applied regardless of the length of the precipitation event.

Hydraulic Routing Specifications

The Hydraulic Routing Specifications section allows you to define the hydraulic routing parameters to use in defining the model. These parameters are defined below.

Link Routing Method

This drop-down list allows you to select the routing method to use for routing flow through the stormwater and wastewater network. Each of these routing methods employs the Manning equation to relate flow rate to flow depth and bed (or friction) slope. The one exception is for Circular Force Main pipes under pressurized flow, where either the Hazen-Williams or Darcy-Weisbach equation is used instead.

Flow routing within a channel or pipe is governed by the conservation of mass and momentum equations for gradually varied, unsteady flow (i.e., the Saint Venant flow equations). The software provides a choice on the level of sophistication used to solve these equations. The default routing method is **KINEMATIC WAVE**.

- Hydrodynamic Routing
- Kinematic Wave Routing (default)
- Steady Flow Routing

Hydrodynamic Routing

Hydrodynamic routing is the most sophisticated routing method, and solves the complete one-dimensional Saint Venant flow equations to produce the most theoretically accurate results. The Saint Venant equations consist of the continuity and momentum equations for conduits and a volume continuity equation at nodes.

With this link routing method it is possible to represent pressurized flow when a closed conduit becomes full, such that flows can exceed the full-flow Manning equation value. Flooding occurs when the water depth at a node exceeds the maximum available depth, and the excess flow is either lost from the system or can pond atop the node and re-enter the drainage system.

Hydrodynamic routing can account for channel storage, backwater, entrance losses, exit losses, flow reversal, and pressurized flow. Because it couples together the solution for both water levels at nodes and flow in conduits it can be applied to any general network layout, even those containing multiple downstream diversions and loops. It is the method of choice for systems subjected to significant backwater effects due to downstream flow restrictions and with flow regulation via weirs and orifices. This generality comes at a price of having to use much smaller time steps, on the order of a minute or less (the software will automatically reduce the user-defined maximum time step as needed to maintain numerical stability).

Kinematic Wave Routing (default method)

Kinematic wave routing solves the continuity equation along with a simplified form of the momentum equation in each channel or pipe (conduit). The momentum equation requires that the slope of the water surface equal the slope of the conduit.

The maximum flow that can be conveyed through a conduit is the full-flow Manning equation value. Any flow in excess of this entering the inlet node is either lost from the system or can pond atop the inlet node and be reintroduced into the conduit as capacity becomes available.

Kinematic wave routing allows flow and area to vary both spatially and temporally within a conduit. This can result in attenuated and delayed outflow hydrographs as inflow is routed through the channel. However, this form of routing cannot account for backwater effects, entrance losses, exit losses, flow reversals, or pressurized flow, and is also restricted to dendritic (i.e., not looped) network layouts. It can usually maintain numerical stability with moderately large time steps, on the order of 5 to 15 minutes. If the previously mentioned limitations are not expected to be significant, then this link routing method can be accurate and efficient, especially for long-term simulations.

Steady Flow Routing

Steady flow routing represents the simplest type of routing possible (actually no routing) by assuming that within each computational time step flow is uniform and steady. Thus it simply translates inflow hydrographs at the upstream end of a channel or pipe to the downstream end, with no delay or change in shape. The Manning equation is used to relate flow rate to flow area (or depth).

This type of routing cannot account for channel storage, backwater effects, entrance/exit losses, flow reversal, or pressurized flow. It can only be used with dendritic conveyance networks, where each node has only a single outflow link (unless the node is a flow diversion element, in which case two outflow links are required). This form of routing is insensitive to the defined time step and is really only appropriate for preliminary analysis for extremely large networks or when performing long-term continuous simulations.

Force Main Equation (optional)

This drop-down list allows you to select which equation will be used to compute friction losses during pressurized flow for pipes that have been assigned a **CIRCULAR FORCE MAIN** shape in the Conveyance Links dialog box. The following options are available:

- Hazen-Williams equation (default)
- Darcy-Weisbach equation

Minimum Conduit Slope

The entry specifies the minimum value allowed for a conduit's slope (%). If this entry is left blank or zero value is entered, then no minimum conduit slope is imposed, although the software uses a lower limit on elevation drop of 0.001 ft (0.00035 m) over the entire length of the conduit when computing the conduit slope.

Computational & Reporting Options

This section allows you to define the additional computational parameters to use in defining the model, along with output reporting options. These parameters are defined below.

Storage Node Exfiltration Method (optional)

This drop-down list allows you to select the exfiltration (sometimes called infiltration) method to account for loss of water from a storage node (i.e., detention pond) as the result of percolation or absorption into the surrounding soil. The following exfiltration methods are available:

- None (default)
- Constant Flow
- Constant Rate, Free Surface Area
- Constant Rate, Projected Area
- Constant Rate, Wetted Area
- Horton, Free Surface Area
- Horton, Projected Area
- Horton, Wetted Area

None (default method)

No loss of water from the storage node is accounted for.

Constant Flow

This exfiltration method removes water from the storage node at a constant flow rate during the entire duration of the routing simulation.

Constant Rate

This exfiltration method removes water from the storage node using a user-specified exfiltration rate, to compute a flow rate for each time step during the routing simulation. The computed flow rate is dependent upon the storage node's water surface elevation at each time step, and is also dependent upon whether **FREE SURFACE AREA**, **PROJECTED AREA**, or **WETTED AREA** was selected. Each storage node can have its own user-specified exfiltration rate.

Horton

This exfiltration method removes water from the storage node using user-specified initial and final exfiltration rates and a decay coefficient, to compute a flow rate for each time step during the routing simulation.

This exfiltration method is based on empirical observations showing that exfiltration decreases exponentially from an initial maximum rate to some minimum rate over the course of an event. The decay coefficient that describes how fast the exfiltration rate decreases over time as the surrounding ground becomes more saturated.

The computed flow rate is also dependent upon the storage node's water surface elevation at each time step, and is also dependent upon whether **FREE SURFACE AREA**, **PROJECTED AREA**, or **WETTED AREA** was selected. Each storage node can have its own user-specified exfiltration rate.

Free Surface Area

With this method, the exfiltration rate is computed using the storage node's surface area for the water surface elevation at each time step during the routing simulation. This method does not consider side-areas, and is not effected by the depth of the storage node.

Projected Area

With this method, the exfiltration rate is computed using the storage node's occupied volume. For storage nodes with outward sloping sidewalls, this method is the same as the **FREE SURFACE AREA** method. However, when the sidewalls slope inwards (as with underground storage structures), this method considers the projected area occupied by the stored water. For example, a horizontal underground storage pipe that is completely filled has a surface area of 0, but a corresponding projected area that is defined by the pipe's diameter.

Wetted Area

With this method, the exfiltration rate is computed using the total area of all wetted surfaces, regardless if the sidewalls slope outward, inward, or are vertical. For natural ponds with mild-sloped sidewalls, the **WETTED AREA** and **FREE SURFACE AREA** methods will produce similar results. However, for storage vaults with vertical sidewalls, the two methods will produce vastly different results.

Enable Overflow Ponding at Nodes

Check this option to allow excess water to collect atop junction nodes and be reintroduced into the system as conditions permit. In order for ponding to actually occur at a particular node, a non-zero value for a junction's **PONDED AREA** data field must be specified.

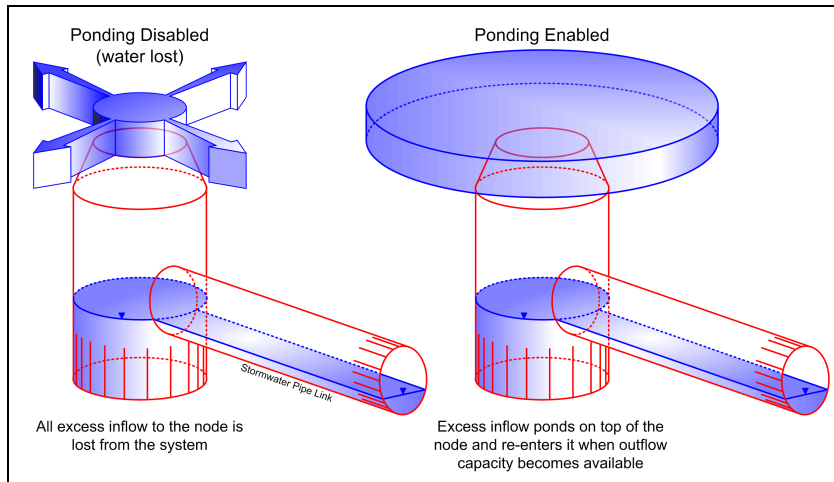

Figure 6.6 How overflow ponding is specified

Skip Steady State Analysis Time Periods

Check this option to make the simulation use the most recently computed conveyance system flows during steady state periods instead of computing a new flow routing solution. A time step is considered to be in steady state if the change in external inflows at each node is below 0.5 cfs and the relative difference between total system inflow and outflow is below 5%. Enabling this option can significantly speed up a large continuous simulation model.

This option is only available for the EPA SWMM hydrology method. Note that if the pond exfiltration is specified, then this option is grayed out (i.e., unavailable) and the analysis is checked at each time step for a change in the detention pond.

Include Input Data in ASCII Output Report

Check this option if you want the ASCII Output Report to include a summary listing of the project input data.

Include Control Actions in ASCII Output Report

Check this option if you want the ASCII Output Report to list all discrete control actions taken by the Control Rules associated with a project (i.e., reporting of a pump turning on or off, etc.). Note that continuous modulated control actions are not listed.

If a lot of control actions are to take place during a simulation, then the ASCII Output Report can have a large section containing all of the control actions that took place. Therefore, it is recommended that this option only be used for short-term simulations.

Disabling Hydrology, Hydraulics, and Other Computations

Note that the Analysis Options dialog box allows you to disable various components of the defined model. For example, you can disable the water quality component of the defined model and only analyze the hydrology and hydraulic routing of the model. See the section titled *Analysis Computations* on page 72 for more information.

Hydrology Method Limitations

Urban stormwater hydrology is not an exact science. While the hydrologic processes are well-understood, the necessary equations and boundary conditions required to solve them are often quite complex. In addition, the required data is often not available.

In the hydrologic analysis of a development site, there are a number of variable factors that affect the nature of stormwater runoff from the site. Some of the factors that must be considered include:

- Rainfall amount and storm distribution
- Drainage area size, shape, and orientation
- Ground cover and soil type
- Slopes of terrain and stream channel(s)
- Antecedent moisture condition
- Storage potential (floodplains, ponds, wetlands, reservoirs, channels, etc.)
- Watershed development potential
- Characteristics of the local drainage system

The following subsections describe the advantages and limitations inherent with some of the subbasin hydrology methods provided. When these hydrology methods are used for design calculations, it is important to understand the assumptions and limitations before a particular method is selected.

Rational Method

The Rational Method is recommended for small, highly-impervious drainage areas, such as parking lots and roadways draining into inlets and gutters. The American Society of Civil Engineers Water Environment Federation, "Design and Construction of Urban Stormwater Management Systems," 1992 edition, states

that the Rational Method is not recommended for drainage areas much larger than 100-200 acres.

- Can be used for estimating peak flows and the design of small site or subdivision storm sewer systems.
- Planning level calculations up to 160 acres.
- Detailed final design for peak runoff calculations of smaller homogeneous drainage areas of up to 60 acres.
- Relatively uniform basins in land use and topography.
 - These basins should be broken down into subbasins of like uniformity and routing methods applied to determine peak runoff at specified points.
 - The averaging of the significantly different land uses through the runoff coefficient of the Rational Method should be minimized where possible.
 - For basins that have multiple changes in land use and topography, the design storm runoff should be analyzed by other methods.
- Should not be used for storage volume design (i.e., detention pond sizing, etc.).

Modified Rational Method

The Modified Rational Method is a variation of the Rational Method, developed mainly for the sizing of detention facilities in urban areas. The above limitations of the Rational Method apply, except that the Modified Rational Method may be used for storage volume design.

The Modified Rational Method is applied similarly to the Rational Method except that it utilizes a fixed rainfall duration. The selected rainfall duration depends on the specified requirements. For example, you might perform an iterative calculation to determine the rainfall duration which produces the maximum storage volume requirement when sizing a detention basin.

SCS TR-55 Method

The NRCS (SCS) Urban Hydrology for Small Watersheds TR-55 Method has wide application for existing and developing urban watersheds up to 2,000 acres. The SCS TR-55 Method requires data similar to the Rational Method: drainage area, a runoff factor, time of concentration and rainfall. However, the SCS TR-55 method is more sophisticated in that it also considers the time distribution of the rainfall, the initial rainfall losses to interception and depression storage and an infiltration rate that decreases during the course of a storm.

- Can be used for drainage areas up to 2,000 acres.
- For areas larger than 2,000 acres, the SCS TR-20 hydrology method can be used.
- If using rain gages to assign a storm precipitation to the model, only one rain gage can be assigned to either a SCS TR-55 or SCS TR-20 hydrology method model.

Specialized Hydrology Modeling

If more specialized hydrology must be simulated, such as continuous simulation, pollutants, groundwater, or snowmelt, then the EPA SWMM hydrology method must be used.

Continuous Simulations

Only the EPA SWMM hydrology method supports continuous simulations. All of the other hydrology methods are limited to a single storm event due to the fact that provision is not made for soil moisture recovery during periods of no precipitation.

Pollutant Buildup and Washoff Simulations

Only the EPA SWMM hydrology method supports surface pollutant buildup and pollutant washoff simulations. The other hydrology methods are limited to modeling rainfall runoff and not water quality pollutants.

Groundwater Aquifer Simulations

Only the EPA SWMM hydrology method supports groundwater aquifer recharge and discharge simulations. All of the other hydrology methods are limited to surface water hydrology. If a detailed groundwater model study is required, then a more complete groundwater model such as the USGS MODFLOW should be used.

Snowpack and Snowmelt Simulations

Only the EPA SWMM hydrology method supports snowpack accumulation and snowmelt simulations. All of the other hydrology methods are limited to rainfall precipitation event modeling. If a more detailed winter conditions model study is required, then a more complete snowpack accumulation and snowmelt model such as the NRCS AnnAGNPS should be used.

ID Labels

This tabbed pane is used to define the automatic labeling format for ID labels for new elements as they are defined. Then, when constructing a network model, the software will assign ID labels to elements automatically. If desired, the labeling format can be saved out so that it can be re-used on other projects.

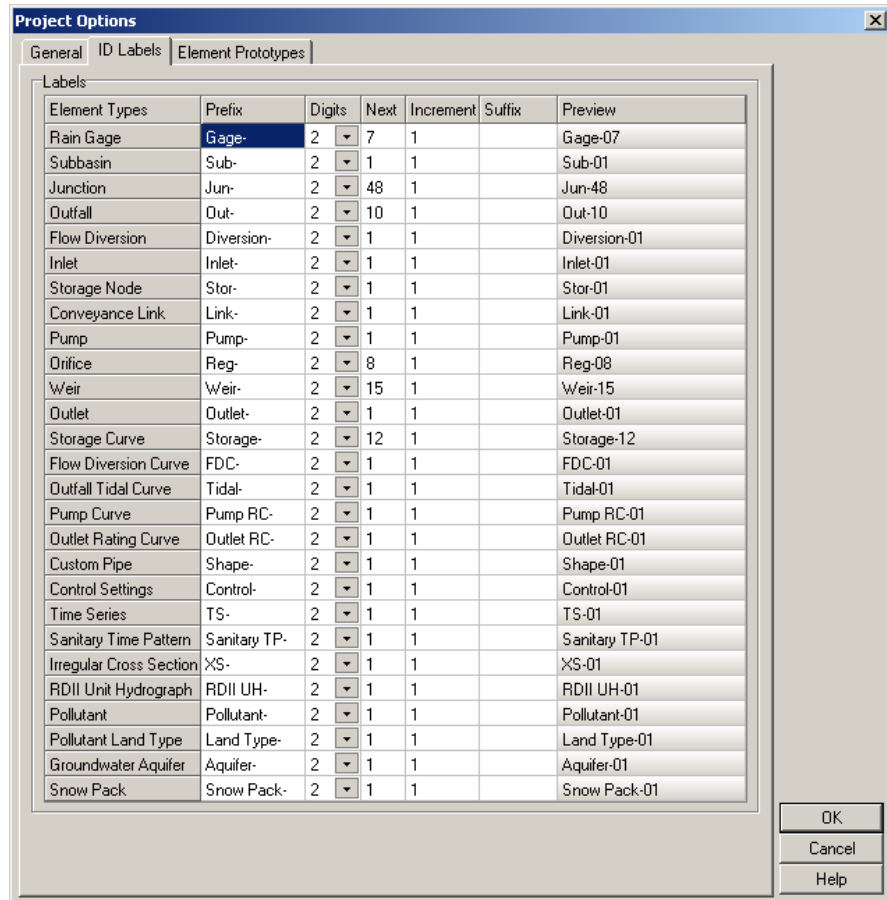

Figure 6.7 The Project Options dialog, ID Labels tabbed pane

The ID Labels tab contains a table, listing all of the network element types for which automatically labeling can be defined for. The following fields (or columns) are used to define the network element ID labels.

Element Types

This column lists all of the individual network element types in which an ID label is assigned to. Scroll up and down through the list to see the various element types.

Prefix

This field defines the letters and/or numbers that appear in front of the ID label for the element type being defined.

Digits

This field defines the minimum number of digits that the ID label should have. For example, defining a digit setting of 3 would cause ID labels of 001, 010, 100, and 1000 as new elements are created.

Next

This field defines the integer value to use as the starting ID number portion of the label. The software will then generate ID labels beginning with this number and will choose the first available unique ID label.

Increment

This field defines the integer amount that is to be added to the ID number portion of the ID label, after each element is created, to determine the ID number portion for the next element.

Suffix

This field defines the letters and/or numbers that appear after the ID number portion of the ID label for the element type being defined.

Preview

This field displays an example of how the label will appear based upon the labeling fields for the element type being defined.

Element Prototypes

The Element Prototypes tabbed pane is used to define prototypes (sometimes called templates) and default values to be used when creating pipe network elements in the model.

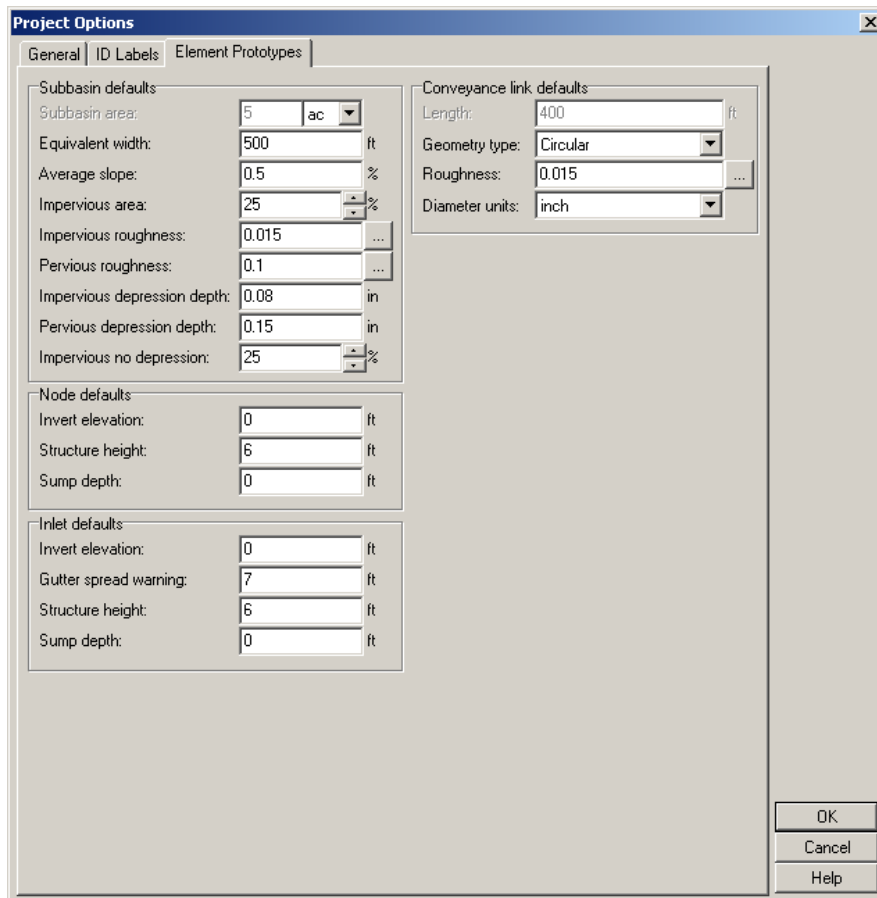

Figure 6.8 The Project Options dialog, Element Prototypes tabbed pane

The following options are available in the Element Prototypes tabbed pane of the Project Options dialog box.

Conveyance Link Defaults

This section defines the default property values to be used when a channel or pipe is first created. These values can then be modified to represent the properties of a specific channel or pipe using the Conveyance Links dialog box. These property values are placeholder values, until actual values that represent the channel or pipe being defined are specified. Channels and pipes are explained in the section titled *Channel, Pipe & Culvert Links* on page 187.

Diameter Units

This drop-down list allows you to select the units to use for defining pipe diameters. The following units are available:

US Units

- Inches
- Feet

SI Metric Units

- Millimeters
- Centimeters
- Meters

Subbasin Defaults

This section defines the default property values to be used when a subbasin is first created. These values can then be modified to represent the properties of a specific subbasin using the Subbasins dialog box. These property values are placeholder values, until actual values that represent the subbasin being defined are specified. Subbasins are explained in the section titled *Subbasins* on page 317.

Subbasin Area Units

This drop-down list allows you to select the units to use for defining subbasin areas. The following units are available:

US Units

- Acres (default)
- Square Feet

SI Metric Units

- Hectares (default)
- Square Meters

Generally, acres (for US units) and hectares (for SI metric units) are used. However, for small sites, acres and hectares do not provide enough precision and square feet and square meters should be selected.

Junction Defaults

This section defines the default property values to be used when a junction node is first created. These values can then be modified to represent the properties of a specific junction node using the Junctions dialog box. Junction structures are explained in the section titled *Junctions* on page 214.

Sump Depth

As stormwater enters a junction, there can be a sump to capture sediment, debris, and associated pollutants. Sumps are also used in combined sewers to capture floatables and settle some solids. The entry defines the depth of that sump. Any pipes that are then connected to the structure will be placed so that their pipe invert is above the structure invert by the defined sump depth.

Structure Height

This field defines the default hydraulic height of the storm drain catch basin structure.

Inlet Defaults

This section defines the default property values to be used when a storm drain inlet is first created. These values can then be modified to represent the properties of a specific storm drain inlet using the Inlets dialog box. Inlet structures are explained in the section titled *Storm Drain Inlets* on page 224.

Sump Depth

As stormwater enters a storm drain inlet, there can be a sump in the catch basin to capture sediment, debris, and associated pollutants. The entry defines the depth of that sump. Any pipes that are then connected to the structure will be placed so that their pipe invert is above the structure invert by the defined sump depth.

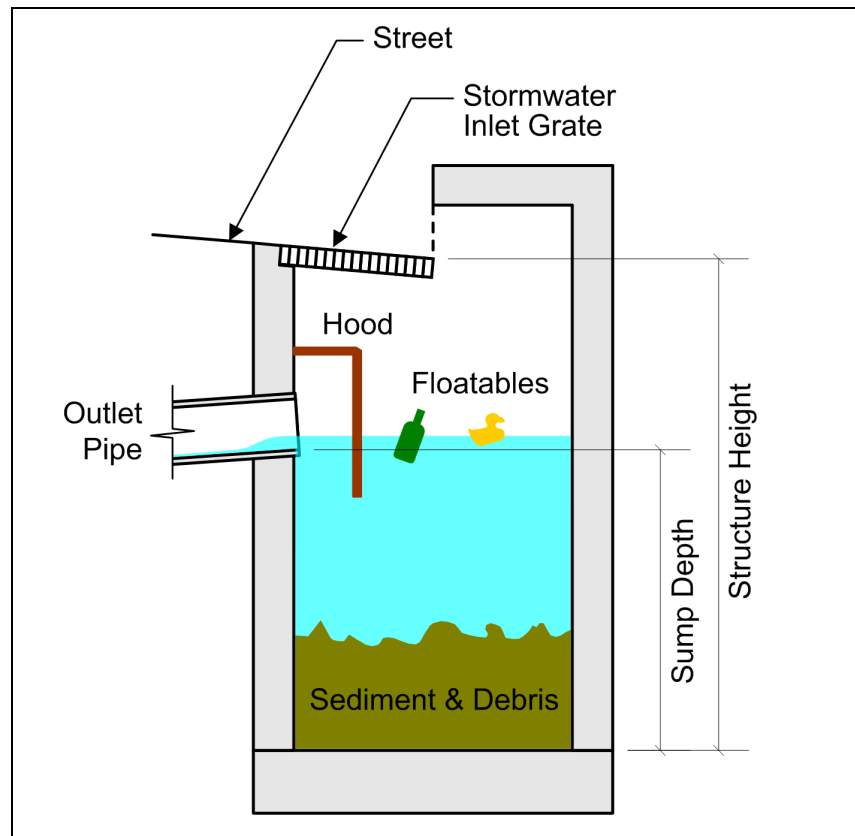

Figure 6.9 Illustration of a storm drain inlet catch basin structure

Sumps in a catch basin act as stormwater pretreatment by capturing large sediments. The performance of a catch basin at removing sediment and other pollutants depends on the design of the catch basin (i.e., the size of the sump, etc.), and routine maintenance to clean out the sump of any captured sediment.

The following criteria have been described for sizing an "optimal" catch basin for stormwater pretreatment, which relates all catch basin dimensions to the diameter of the outlet pipe (D).

- The catch basin length and width (or diameter for a round catch basin) should be at least equal to $4 \times D$.
- The sump depth should be at least $4 \times D$. In addition, the sump depth should be increased if cleaning is infrequent or if the area draining to the catch basin has high sediment loads.
- The top of the catch basin outlet pipe should be $1.5 \times D$ below the top of the catch basin.

Catch basin sumps should also be sized to accommodate the annual estimated sediment volume that will enter the catch basin, with a factor of safety included.

Structure Height

This field defines the default hydraulic height of the storm drain catch basin structure.

Inlet Gutter Spread Warning

This entry is used to manage when a storm drain inlet is flagged in a red color in the Inlets dialog box for the field Gutter Spread during Peak Flow. When the computed gutter spread is more than this value, then the field will change to a red color. The default value is 7 ft (2 m), which typically corresponds to $\frac{1}{2}$ of the roadway lane is covered with stormwater (2 ft gutter and $\frac{1}{2}$ of a 10 ft wide roadway lane).

Network Element Data

7

This chapter describes the network element data used to define a stormwater or sanitary (wastewater) sewer model.

Channel, Pipe & Culvert Links

Channels, pipes, and culverts are links that move water from one node to another in the drainage network. A wide variety of cross-sectional shapes can be selected for channels (open geometry) as well as for pipes and culverts (closed geometry). Custom pipe shapes and irregular natural cross-section shapes are also supported.

The software uses the Manning's equation to compute the flow rate in open channels and partially full closed conduits. For standard US units:

$$Q = \frac{1.49}{n} AR^{\frac{2}{3}} \sqrt{S}$$

where:

- Q = flow rate
- n = Manning roughness coefficient
- A = cross-sectional area
- R = hydraulic radius
- S = energy slope

For Steady Flow and Kinematic Wave routing, the energy slope (S) is interpreted as the conduit slope. For Hydrodynamic routing, the energy slope is the friction slope (i.e., head loss per unit length). For Circular Force Main pipes either the Hazen-Williams or Darcy-Weisbach formula is used in place of the Manning equation when fully pressurized flow occurs.

For US units the Hazen-Williams formula is:

$$Q = 1.318CAR^{2/3}S^{1/2}$$

where:

- C = Hazen-Williams C-factor, which varies inversely with surface roughness

The Darcy-Weisbach formula is:

$$Q = \sqrt{\frac{8g}{f}} AR^{1/2} S^{1/2}$$

where:

- f = Darcy-Weisbach friction factor
- g = acceleration of gravity

For turbulent flow, the Darcy-Weisbach friction factor is determined from the height of the roughness elements on the walls of the pipe (supplied as an input parameter) and the flow's Reynolds Number using the Colebrook-White equation. The choice between using the Hazen-Williams or Darcy-Weisbach equation for pressurized force mains is provided in the Project Options dialog box (see page 175).



A pipe does not have to be assigned as Circular Force Main shape for it to pressurize. Any of the available pipes can potentially pressurize and function as force mains using the Manning equation to compute friction losses.

For culvert modeling, the software uses the culvert hydraulics based on the Federal Highway Administrations (FHWA) standard equations from the publication *Hydraulic Design of Highway Culverts* (FHWA Publication No. FHWA-NHI-01-020, May 2005). Culverts are checked continuously during the flow routing to see if they operate under inlet control or outlet control. Under inlet control, a culvert obeys a particular flow versus inlet depth rating curve dependent upon the culvert's shape, size, slope, and inlet geometry.

The culvert routines include the ability to model circular, box, elliptical, arch, and pipe arch culverts. The software has the ability to model multiple culverts at a single roadway crossing. The culverts can have different shapes, sizes, elevations, and loss coefficients. You can also specify the number of identical barrels for each culvert type.

The principal input parameters for channels, pipes, and culverts are:

- Inlet and outlet nodes
- Conduit inlet and outlet node invert elevations (or offsets above the node inverts)
- Conduit length
- Manning's (or equivalent) roughness
- Cross-sectional geometry
- Entrance and exit losses
- Presence of a flap gate to prevent flow reversal

The Conveyance Links dialog box, as shown in the following figure, is displayed when an existing channel, pipe, or culvert link is selected for editing by double-clicking it in the Plan View using the **SELECT ELEMENT**  tool. Also, you can choose **INPUT**  **CONVEYANCE LINKS** or double-click the **CONVEYANCE LINKS**  icon from the data tree to display the Conveyance Links dialog box.

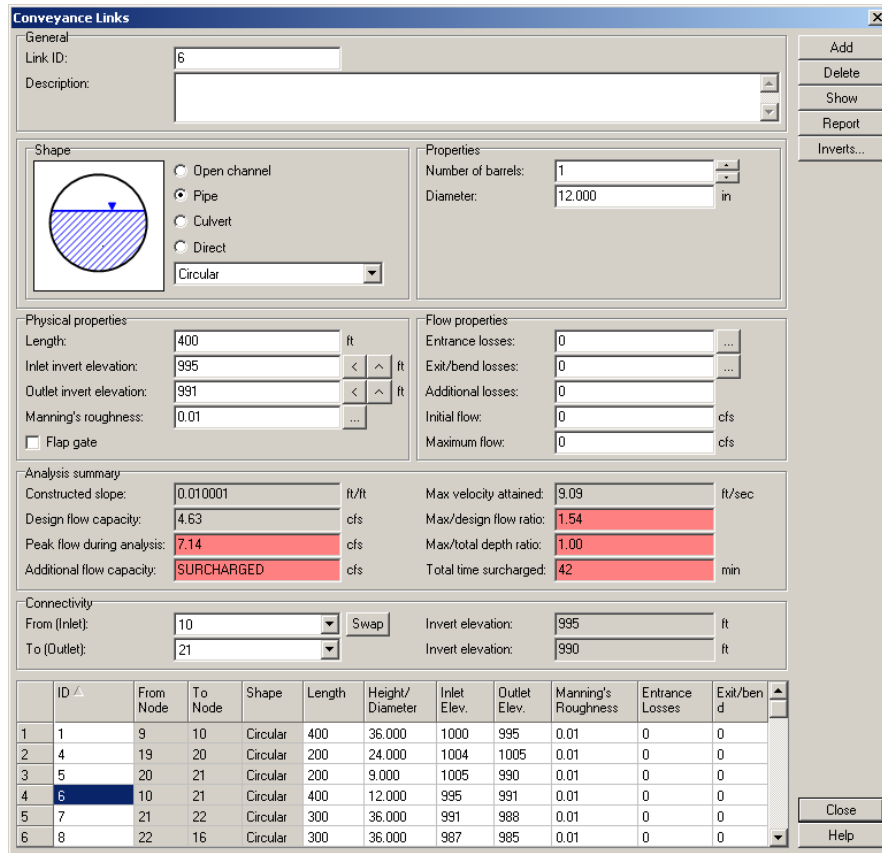

Figure 7.1 The Conveyance Links dialog box

To select a channel, pipe, or culvert, scroll through the displayed table and click the row containing the element of interest. The data entry fields will then display the information describing the selected element.

To add a new channel, pipe, or culvert, it is recommended that the link be added interactively on the Plan View using the **ADD CONVEYANCE LINK** tool. However, a new channel, pipe, or culvert can be manually added by clicking the Add button and then entering the appropriate information in the data fields. To delete an existing channel, pipe, or culvert, select the element from the table and then click the Delete button. Click the Show button to zoom to a region around the currently selected link in the Plan View, and then highlight the element. Click the Report button to generate a Microsoft Excel report detailing all currently defined links input data and any corresponding analysis results.

The following illustration details the input data required to define a channel, pipe, or culvert link within the software.

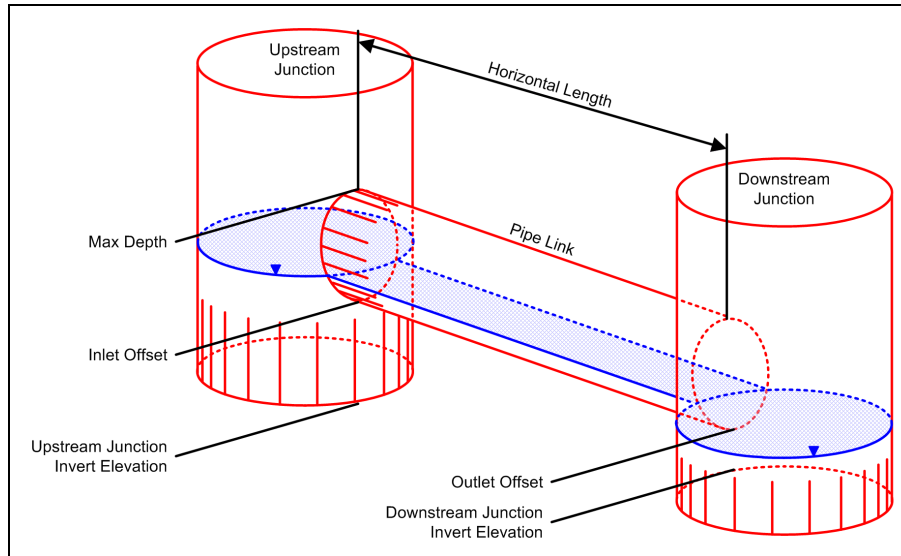

Figure 7.2 The input data used to define a channel, pipe, or culvert element

The following data are used to define a channel, pipe or culvert:

Link ID

Enter the unique name (or ID) that is to be assigned to the channel, pipe, or culvert being defined. This name can be alphanumeric (i.e., contain both numbers and letters), can contain spaces, is case insensitive (e.g., $ABC = abc$), and can be up to 128 characters in length. Therefore, the assigned name can be very descriptive, to assist you in identifying different channel, pipe, and culvert elements.

A new link ID is automatically defined by the software when a new channel, pipe, or culvert element is added. However, the link ID can be changed within this field.

When importing (or merging) multiple stormwater or sanitary sewer network models into a single model, the software will check for collisions between identical link IDs and can automatically assign a new link ID for any elements being imported that contain the same link ID as already exist in the network model. See the section titled *Merging Network Models* on page 494 for more information.

Description (optional)

Enter an optional description that describes the link being defined.

Shape

This radio button group and drop-down entry allows you to select whether a channel, pipe, culvert, or direct (connection) is being defined. When selecting a channel, pipe, or culvert, then choose the appropriate shape as shown in the following tables. After a shape is selected, the appropriate data entry fields appear for describing the dimensions of that shape. Length dimensions are in feet (for US units) and meters (for SI metric units).

Most open channels can be represented with a rectangular, trapezoidal, or user-defined irregular cross-section shape. The most common shapes for new drainage and sewer pipes are circular, elliptical, and arch pipes. They come in standard sizes that are published by the American Iron and Steel Institute in

Modern Sewer Design and by the American Concrete Pipe Association in the *Concrete Pipe Design Manual*. The most common shapes for new culverts are circular and box (rectangular) culverts.

Selecting **DIRECT** as the link type causes flow to be instantly routed from the upstream inlet to the downstream inlet without considering any losses in the routing. A direct link has no physical properties such as length and diameter. This link type is useful when needing to link two adjacent nodes without having to define how the flow gets routed from the upstream node to the downstream node. It has no hydraulic effect in the model other than to define hydraulic connectivity and preserve continuity relationships.

Selecting **USER-DEFINED** as the open channel shape allows you to select an already defined user-defined cross-section geometry from the drop-down list. Clicking the (...) browse button will display the Irregular Cross Sections dialog box, allowing you to define the irregular channel geometry or view those that have already been defined. The Irregular Cross Sections dialog box is described in the section titled *Irregular Cross Sections* on page 211.

Selecting **FILLED CIRCULAR** as the pipe type allows the bottom of a circular pipe to be filled with sediment and thus limit its flow capacity.

Selecting **CUSTOM** as the pipe shape allows you to select an already defined user-defined custom pipe geometry from the drop-down list. Clicking the (...) browse button will display the Custom Pipe Geometry dialog box, allowing you to define a new closed geometrical shaped pipe that is symmetrical about the pipe centerline or view those that have already been defined. This shape specifies how the width of the pipe cross-section varies with height, where both width and height are scaled relative to the pipe's maximum height. This allows the same pipe shape to be used for pipes of differing sizes. The Custom Pipe Geometry dialog box is described in the section titled *Custom Pipe Geometry* on page 210.

Table 7.1 Available open channel shapes

Rectangular		Trapezoidal	
Triangular		Parabolic	
Power		User Defined	

Table 7.2 Available culvert shapes

Circular 	Box 
Horizontal Ellipse 	Vertical Ellipse 
Pipe Arch 	Arch 

Table 7.3 Available pipe shapes

<p>Circular</p> 	<p>Circular Force Main</p> 
<p>Rectangular</p> 	<p>Filled Circular</p> 
<p>Rectangular & Triangular</p> 	<p>Rectangular Circular</p> 
<p>Horizontal Ellipse</p> 	<p>Vertical Ellipse</p> 
<p>Semi-Elliptical</p> 	<p>Arch</p> 
<p>Basket Handle</p> 	<p>Modified Basket Handle</p> 
<p>Egg</p> 	<p>Horseshoe</p> 
<p>Gothic</p> 	<p>Catenary</p> 
<p>Semi-Circular</p> 	<p>Custom</p> 

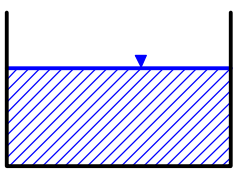
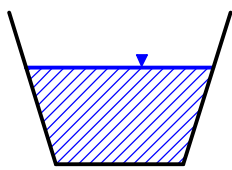
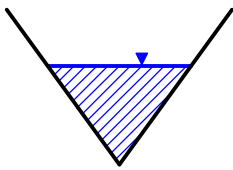
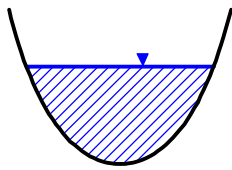
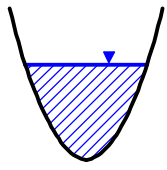
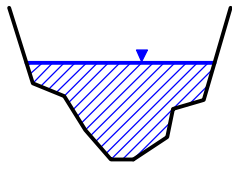
Number of Barrels

This spin control specifies how many identical parallel channels, pipes, or culverts are being defined. A maximum of 100 identical parallel link elements is allowed.

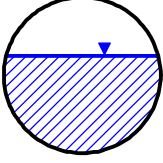
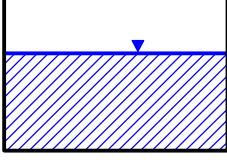
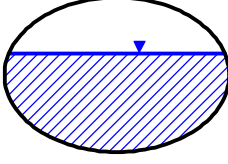
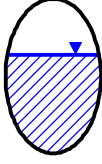
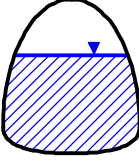
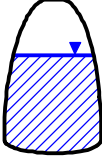
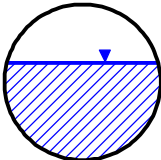
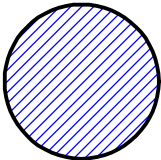
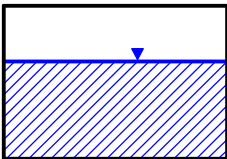
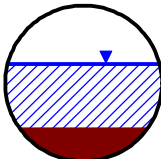
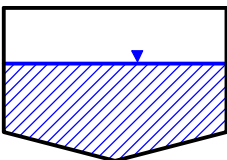
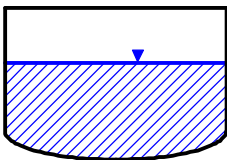
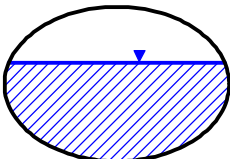
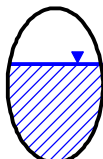
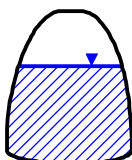
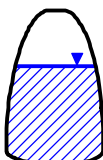
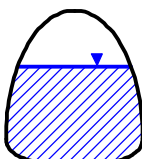
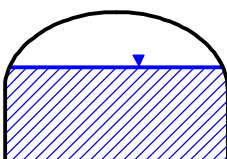
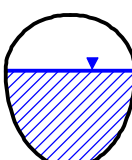
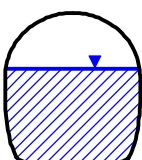
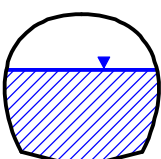
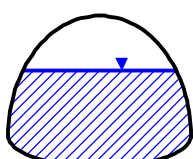
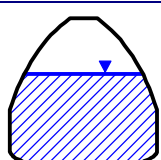
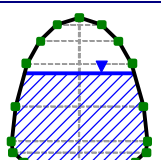
Culvert Type (Culvert only)

This field is used to select the Federal Highway Administration culvert type being modeled. Once you have selected a culvert shape, the corresponding FHWA chart types will show up in this selection drop-down list.

Culvert Entrance (Culvert only)

This field is used to select the Federal Highway Administration culvert entrance details. Once you have selected a culvert shape and type, the corresponding FHWA culvert entrance details will show up in the selection drop-down list.

Diameter**Height****Maximum Depth**

Diameter of a circular pipe or culvert, height of a box culvert, or maximum depth of the channel cross section (ft/inches or m/cm). See Figure 7.2 on page 190 for an illustration of this value.

Note that the units (ft/inches or m/cm) is defined by the entry **DIAMETER UNITS** in the Project Options dialog box, Elements Prototype tab, described on page 182.

Filled Depth

Depth of fill (or sediment) in a circular pipe (ft/inches or m/cm) when defining a Filled Circular pipe type.

Width

Width for the following link shapes (ft/inches or m/cm):

- Rectangular pipe
- Rectangular culvert
- Pipe arch culvert

Bottom Width

Bottom width for the following link shapes (ft/inches or m/cm):

- Rectangular open channel
- Trapezoidal open channel
- Modified basket handle pipe

Top Width

Top width for the following link shapes (ft/inches or m/cm):

- Triangular open channel
- Parabolic open channel
- Power open channel
- Rectangular & triangular pipe
- Rectangular & circular pipe

Maximum Width

Maximum width for the following link shapes (ft/inches or m/cm):

- Horizontal elliptical pipe
- Vertical elliptical pipe
- Horizontal elliptical culvert
- Vertical elliptical culvert
- Arch pipe
- Arch culvert

Left Side Slope (Trapezoidal Channel only)

Left side slope for a **TRAPEZOIDAL** channel, represented as ratio of vertical to horizontal distance. For example, a value of 1:20 represents a left side wall slope equal to a 1 ft rise over a 20 ft run.

Right Side Slope (Trapezoidal Channel only)

Right side slope for a **TRAPEZOIDAL** channel, represented as ratio of vertical to horizontal distance. For example, a value of 1:20 represents a right side wall slope equal to a 1 ft rise over a 20 ft run.

Exponent (Power Channel only)

Exponent used for a **POWER** channel.

Hazen-Williams C-Factor (Force Main only)

Darcy-Weisbach Roughness Height

Used to define the pipe roughness when a **CIRCULAR FORCE MAIN** pipe experiences pressure flow. This entry defines the *Hazen-Williams C-Factor* or *Darcy-Weisbach Roughness Height* pressurized roughness, depending upon which **FORCE MAIN EQUATION** is specified in the Project Options dialog box, General tab (described on page 175).

Clicking the browse button will display a reference dialog box showing either Hazen-Williams or Darcy-Weisbach roughness coefficient values, allowing you to determine the appropriate roughness coefficient to use. When defining Darcy-Weisbach roughness heights, these values are defined in inches for US units and mm for SI metric units.

Length

Horizontal length (ft or m) of the channel, pipe, or culvert link being modeled. See Figure 7.2 on page 190 for an illustration of this value.

Note that the channel, pipe, and culvert horizontal length is automatically determined as you digitize it on the Plan View. However, you can over-ride this length by entering a different value in this field. If you want to have the software recompute all of the channel, pipe, and culvert lengths based upon what is currently digitized in the Plan View, select **DESIGN ► RECOMPUTE LENGTHS**.

Note that the length specified must be greater than 0.0. If you are attempting to connect two nodes that are physically attached to each other (e.g., a storage node and a flow diversion structure), you can either use a **DIRECT** link type or you can connect the two nodes with a short length of channel, pipe, or culvert. If using a short length of channel, pipe, or culvert, a length of 0.1 can be used to define this connection.

Inlet Invert Elevation (or Inlet Offset)

Elevation of the channel, pipe, or culvert link inlet invert (or height of the channel, pipe, or culvert link invert above the inlet node invert) in ft or m. See Figure 7.2 on page 190 for an illustration of this value.

The software allows you to work in either elevation or depth mode. Working in elevation mode causes all input data to be entered as elevations above a common datum (e.g., pipe inlet invert elevation). Working in depth mode causes some input data to be entered as a depth offset from the element invert (e.g., pipe inlet invert offset). Elevation is the default mode. Note that this is controlled by the entry **ELEVATION TYPE** in the Project Options dialog box, General tab, described on page 166.

Clicking the  button will cause the pipe (or culvert) invert elevation to be set equal to the connecting node invert elevation. If the link is an open channel element (i.e., not a pipe link) and the node being connected to is a storm drain inlet, selecting this button will cause the channel invert to match the rim (i.e., top) elevation of the inlet (the software assumes that this link element is a curb and gutter link).

Clicking the  button will cause the pipe (or culvert) invert elevation to be set so that the crown (top) of the pipe (or culvert) matches the crown of the largest diameter pipe (or culvert) that already connects to that same junction.

If working in depth mode, then the above two buttons will be grayed out (i.e., unavailable).

Outlet Invert Elevation (or Outlet Offset)

Elevation of the channel, pipe, or culvert link outlet invert (or height of the channel, pipe, or culvert link invert above the outlet node invert) in ft or m. See Figure 7.2 on page 190 for an illustration of this value.

Clicking the  button will cause the pipe (or culvert) invert elevation to be set equal to the connecting node invert elevation. If the link is an open channel element (i.e., not a pipe link) and the node being connected to is a storm drain inlet, selecting this button will cause the channel invert to match the rim (i.e., top) elevation of the inlet (the software assumes that this link element is a curb and gutter link).

Clicking the  button will cause the pipe (or culvert) invert elevation to be set so that the crown (top) of the pipe (or culvert) matches the crown of the largest diameter pipe (or culvert) that already connects to that same junction.

If working in depth mode, then the above two buttons will be grayed out (i.e., unavailable).

Manning's Roughness

This entry defines the Manning's roughness coefficient for the channel, pipe, or culvert link being defined. If defining a force main, this value is used in the Manning's equation to compute the flow rate when the link is not experiencing pressure flow. If defining an irregular cross section, the Manning's roughness is specified in the Irregular Cross Section dialog box (see page 211 for more information) for the left overbank, channel, and right overbank areas.

Clicking the  browse button will display a reference dialog box showing Manning's roughness coefficients, depending upon the type of link being defined (i.e., channel, pipe, or culvert), allowing you to determine the appropriate roughness coefficient to use.

Flap Gate

This check box is used to denote whether a flap gate exists to prevent backflow through the channel, pipe, or culvert link. By default, no flap gate is defined.

Flap gates are generally installed at or near storm drain outlets for the purpose of preventing back-flooding of the drainage system at high tides or high stages in the receiving streams. A small differential pressure on the back of the gate will open it, allowing discharge in the desired direction. When water on the front side of the gate rises above that on the back side, the gate closes to prevent backflow. Flap gates are typically made of cast iron, steel, or rubber, and are available for round, square, and rectangular openings and in various designs and sizes.

Maintenance is a necessary consideration with the use of flap gates. In storm drain systems which are known to carry significant volumes of suspended sediment and/or floating debris, flap gates can act as skimmers and cause brush and trash to collect between the flap and seat. The reduction of flow velocity behind a flap gate may also cause sediment deposition in the storm drain near the outlet. Flap gate installations require regular inspection and removal of accumulated sediment and debris. In addition, for those drainage structures that have a flap gate mounted on a pipe projecting into a stream, the gate must be protected from damage by floating logs or ice during high flows. In these instances, protection must be provided on the downstream side of the gate.

Entrance Losses

This entry defines the head loss coefficient associated with energy losses at the inlet as flow enters a conduit from a node (i.e., junction, inlet, flow diversion, or storage node).

Clicking the browse button will display a reference dialog box showing entrance loss coefficients, allowing you to determine the appropriate entrance loss coefficient to use when modeling a pipe or culvert inlet. This data is also shown below in Table 7.4, assumes outlet control for the pipe entrance loss coefficients.

When modeling open channel flow where the discharge is already channelized and the channel link being defined is simply representing an open channel cross section, then an entrance loss coefficient of 0.0 should be used (i.e., no head loss).

Exit/Bend Losses

Head loss coefficient associated with energy losses at the outlet as flow leaves a conduit and enters a junction.

Clicking the browse button will display a reference dialog box showing exit and bend loss coefficients, allowing you to determine the appropriate value to use when modeling a pipe flowing into a manhole. This data is also shown below in Tables 7.5 and 7.6.

When modeling open channel flow where the discharge is already channelized and the channel link being define is simply representing an open channel cross section, then an exit/bend loss coefficient of 0.0 should be used (i.e., no head loss).

For a sudden expansion such as at an end wall, the exit loss is given by:

$$H_o = \frac{V_o^2}{2g} - \frac{V_d^2}{2g}$$

where:

V_o = average outlet velocity

V_d = channel velocity downstream of outlet

Note that when V_d is approximately 0 as flow exits the conduit into a reservoir, storage node (e.g., detention pond), or wide open channel, the exit loss is one velocity head and an exit/bend loss coefficient of 1.0 should be used (i.e., complete head loss). For partially full flow where the pipe or culvert discharges into a channel with water moving in the same direction as the outlet water, the exit/bend loss coefficient may be reduced to 0 (i.e., no head loss).

Additional Losses (optional)

Head loss coefficient associated with energy losses along the length of the channel, pipe, or culvert link. Typical additional head losses that can be considered are pipe bends, pipe contractions and enlargements, and other transitions.

Initial Flow (optional)

Initial flow rate in the channel, pipe, or culvert link at the start of the simulation (cfs or cms). Generally this value is 0.0 unless you are performing a sanitary wastewater sewer analysis or a continuation of a previous model.

Using a hotstart (or restart) file will automatically populate the initial flow rate for each conveyance link at the start of the simulation—and therefore this field can be ignored when using a hotstart file. For more information on hotstart files, see the section titled *Read/Write External Interface Files* on page 74.

Maximum Flow (optional)

Maximum flow rate allowed in the channel, pipe, or culvert link during the simulation (cfs or cms). Generally this field is left blank (or 0.0) to indicate this field is not applicable. This field is only used when you are needing to throttle the flow rate of the conveyance link.

From (Inlet)

Node ID on the inlet end of the channel, pipe, or culvert link. This node is typically on the end of the channel, pipe, or culvert link with a higher elevation. Clicking the Swap button will switch the inlet and outlet nodes.

To (Outlet)

Node ID on the outlet end of the channel, pipe, or culvert link. This node is typically on the end of the channel, pipe, or culvert link with a lower elevation. Clicking the Swap button will switch the inlet and outlet nodes.

Analysis Summary Section

The Conveyance Links dialog box provides a section titled **ANALYSIS SUMMARY** that provides a brief summary of the simulation results for the selected channel, pipe, or culvert link, as shown in the following figure.

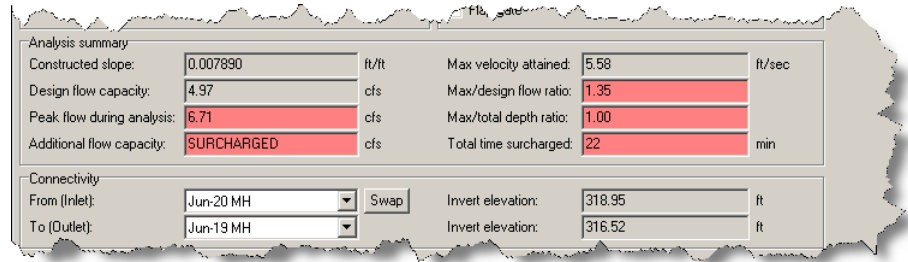

Figure 7.3 The Analysis Summary section of the Conveyance Links dialog box

A description of the available analysis result fields is provided below:

Constructed Slope

This analysis output field provides the channel, pipe, or culvert link slope, in ft/ft (m/m). A positive value denotes that the link is sloped downward towards the outlet, in a downstream fashion. A negative value denotes that the link has an adverse slope (i.e., sloped against the assumed flow direction).

Design Flow Capacity

This analysis output field provides the hydraulic capacity flow rate of the channel, pipe, or culvert link for gravity flow conditions (non-pressurized). Note that the design flow capacity value will dynamically update as you make dimension changes to the pipe being defined. This allows you to size the pipe interactively, by comparing the design flow capacity with the peak flow that was computed during the previous analysis simulation.

The hydraulic capacity is expressed by Manning's formula (for USA units):

$$V = \frac{1.486R^{2/3}S^{1/2}}{n}$$

where:

- V = mean velocity of flow, ft/s
- R = the hydraulic radius, ft, defined as the area of flow divided by the wetted flow surface or wetted perimeter (A/WP)
- S = the slope of hydraulic grade line, ft/ft
- n = Manning's roughness coefficient

In terms of discharge, the above equation can be written as shown below:

$$Q = \frac{1.486AR^{2/3}S^{1/2}}{n}$$

where:

- Q = rate of flow, cfs
- A = cross sectional area of flow, ft²

The software computes the design flow capacity of a pipe for gravity flow conditions at 100% full (i.e., full flow conditions).

Peak Flow during Analysis

This analysis output field provides the peak flow rate that occurred in the channel, pipe, or culvert link during the simulation period. Note that this value can be greater than the design flow capacity of the link.

Additional Flow Capacity

This analysis output field provides difference between the **PEAK FLOW DURING ANALYSIS** and the **DESIGN FLOW CAPACITY** values. However, there are certain conditions in which the software will report **FLOODED**, **> CAPACITY**, or **SURCHARGED** conditions for the link, as described in the below table. In addition, when these conditions occur, the field background changes to a **RED** color to assist you in identifying these conditions.

Link Type	Max/Design Flow Ratio	Max/Total Depth Ratio	Reported Condition
Channel, Pipe, or Culvert	< 1.0	< 1.0	Calculated
Channel	Any Value	1.0	FLOODED
Pipe or Culvert	≥ 1.0	< 1.0	> CAPACITY
Pipe or Culvert	Any Value	1.0	SURCHARGED

Note that the above conditions are also displayed on the Plan View by coloring the channel, pipe, and culvert links as **BLUE** or **RED** to denote flood or surcharge conditions, as shown in the following figure. Additional options for displaying of flooding and surcharging of links and nodes is described in the section titled *Display Options* on page 25.

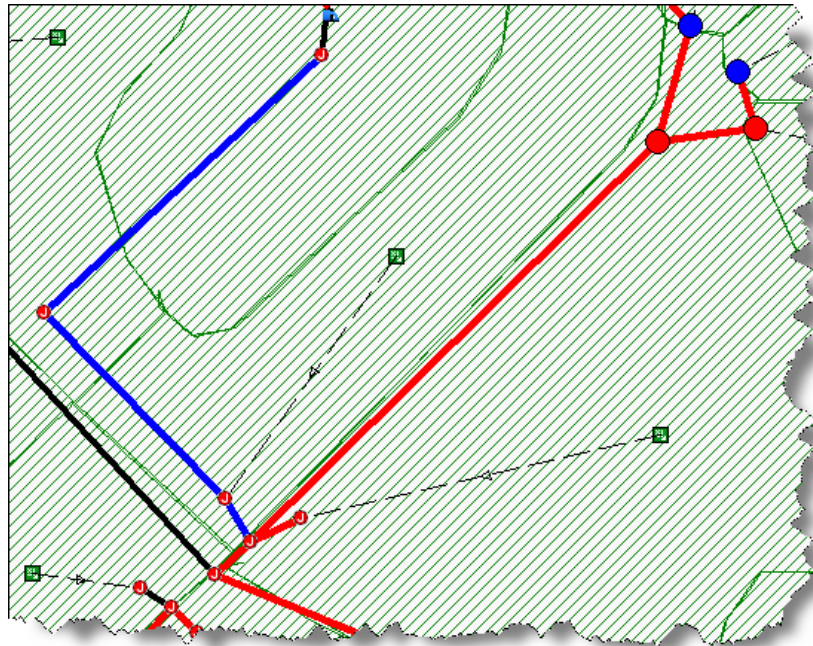

Figure 7.4 The Plan View will color the channel, pipe, and culvert links as **BLUE** or **RED** to denote flood or surcharge conditions

Max Velocity Attained

This analysis output field provides the maximum flow velocity that occurred in the channel, pipe, or culvert link during the simulation period. This value is important to determine whether scour conditions could possibly occur

(usually greater than 6 feet per second) for open natural channels, or whether a minimum “self-cleansing” velocity was obtained (usually 2 to 3 feet per second) for sanitary sewer pipes.

Max/Design Flow Ratio

This analysis output field shows the ratio of **PEAK FLOW DURING ANALYSIS** and the **DESIGN FLOW CAPACITY** values. A value of 1.0 means that the link is running at design flow capacity (i.e., at 100% of capacity). A value greater than 1.0 means that the link is running at greater than the design flow capacity. When this value is greater or equal to 1.0, then the field background changes to a **RED** color to assist you in identifying this condition.

Max/Total Depth Ratio

This analysis output field provides the ratio of the maximum flow depth to the depth of the link. For a pipe or culvert, a value of 1.0 means that the link is running surcharged. For a channel, a value of 1.0 means that the link is running greater than the capacity of the channel and flooding is occurring along the link. When this value is greater or equal to 0.85 (i.e., 85%), then the field background changes to a **RED** color to assist you in identifying this condition.

Total Time Surcharged

This analysis output field provides the time, in minutes, that a link’s **MAX/TOTAL DEPTH RATIO** was equal to 1.0 (i.e., running surcharged or flooded). If any surcharging occurs, then the field background changes to a **RED** color to assist you in identifying this condition.

Junction Losses vs. Entrance & Exit Losses

The underlying routing engine used in the software does not use an energy equation at junctions. Therefore, it cannot apply an entrance/exit loss directly at the junctions. Instead it treats the minor loss at a junction as an additional friction loss within the conduit. Therefore, the software can accurately represent the loss of energy for water entering a conduit from a junction or leaving a conduit and entering a junction. The additional friction loss is expressed as:

$$H_e = \left(\frac{K}{2gL} \right) \times V_e \times \left(\frac{Q}{A} \right)$$

where:

- H_e = exit (or entrance) head loss
- K = loss coefficient
- L = conduit length
- V_e = exit (or entrance) velocity
- Q = conduit flow rate
- A = conduit flow area

The following illustration illustrates the exit and entrance losses associated with conduit flow as it enters and leaves a manhole.

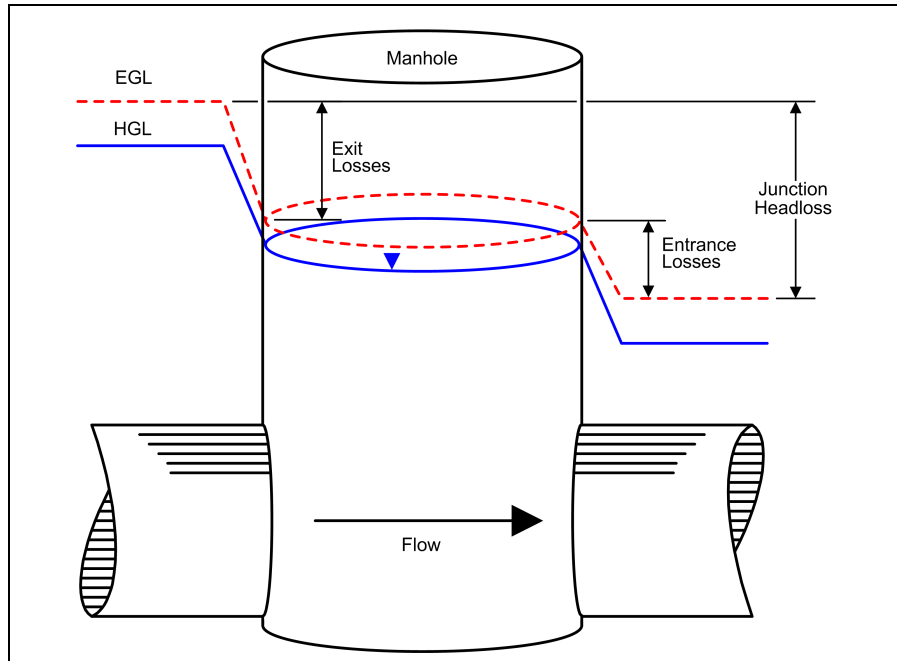

Figure 7.5 The losses associated with conduit flow as it enters and leaves a manhole

The following tables provide you with appropriate head loss coefficients to use for entrance conditions and exit conditions.

Table 7.4 Entrance loss coefficients for closed conduits, assuming outlet control, full or partly full entrance head loss

Structure Type and Entrance Design	Loss Coefficient
Pipe, Concrete	
Projecting from fill, socket end (groove-end)	0.2
Projecting from fill, square cut end	0.5
Headwall or headwall with wingwalls	
Socket end of pipe (groove-end)	0.2
Square-edge	0.5
Rounded (radius = 1/12 barrel diameter)	0.2
Mitered to conform to fill slope	0.7
End section conforming to fill slope ¹	0.5
Beveled edges, 33.7° or 45° angle	0.2
Side-tapered or slope-tapered inlet	0.2
Pipe or Pipe Arch, Corrugated Metal	
Project from fill (no headwall)	0.9
Headwall or headwall with wingwalls square edge	0.5
Mitered to conform to fill slope, paved or unpaved slope	0.7
End section conforming to fill slope ¹	0.5
Beveled edges, 33.7° or 45° angle	0.2
Side-tapered or slope-tapered inlet	0.2
Box, Reinforced Concrete	
Headwall parallel to embankment (no wingwalls)	
Square-edged on 3 edges	0.5
Rounded on 3 edges (radius = 1/12 barrel diameter)	0.2
Beveled edges on 3 sides	0.2
Wingwalls at 30° or 75° angle to barrel	
Square-edged at crown	0.4
Crown edge rounded (radius = 1/12 barrel diameter)	0.2
Beveled top edge	0.2
Wingwalls at 10° or 25° angle to barrel	
Square-edged at crown	0.5
Wingwalls parallel (extension of sides)	
Square-edged at crown	0.7
Side-tapered or slope-tapered inlet	0.2

Source: Normann, J. M., Houghtalen, R. J., and Johnston, W. J., 1985, "Hydraulic Design of Highway Culverts," Hydraulic Design Series No. 5, FHWA Federal Highway Administration, McLean, VA

1 "End-section conforming to fill slope," made of either metal or concrete, are the sections commonly available from manufacturers. From limited hydraulic tests they are equivalent in operation to a headwall in both "inlet" and "outlet" control. Some end sections, incorporating a "closed" tape in their design, have a superior hydraulic performance.

Table 7.5 Exit/Bend Loss Coefficients (clear, non-shaded element corresponds to pipe being defined)

Description	Diagram	Headloss Coefficient
Sewer trunkline with no bend at manhole		0.5
Sewer trunkline with 45° bend at manhole		0.6
Sewer trunkline with 90° bend at manhole		0.8
Large lateral at 90° to sewer trunkline manhole		0.7
Small lateral at 90° to sewer trunkline manhole		0.6

Table 7.6 Exit/Bend Loss Coefficients (continued; clear, non-shaded element corresponds to pipe being defined)

Description	Diagram	Headloss Coefficient
Two sewer lines entering manhole with angle $< 90^\circ$ between two inlet lines		0.8
Two sewer lines entering manhole with angle $\geq 90^\circ$ between two inlet lines		0.9
Three or more sewer lines entering manhole		1.0

FHWA Culvert Computations

The analysis of flow in culverts is complicated. It is common to use the concepts of "Inlet" control and "Outlet" control to simplify the analysis. Inlet control flow occurs when the flow carrying capacity of the culvert entrance is less than the flow capacity of the culvert barrel. Outlet control flow occurs when the culvert carrying capacity is limited by downstream conditions or by the flow capacity of the culvert barrel. The culvert analysis computes the headwater required to produce a given flow rate through the culvert for inlet control conditions and for outlet control conditions. In general, the higher headwater "controls," and an upstream water surface is computed to correspond to that energy elevation.

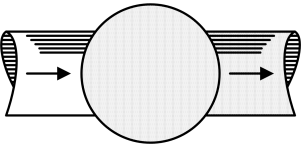
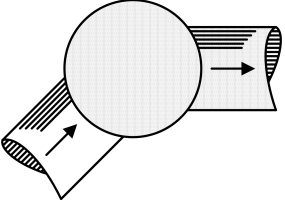
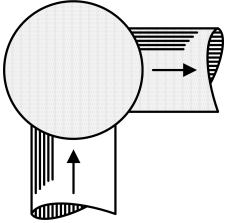
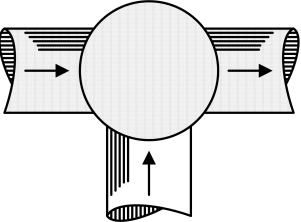
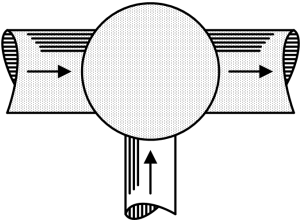
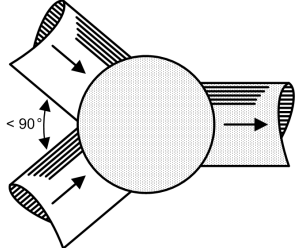
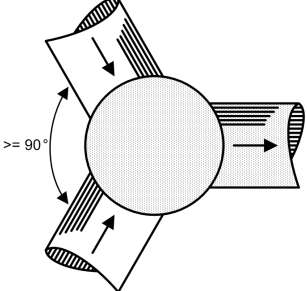
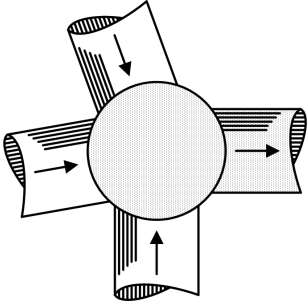
Inlet Control Computations

For inlet control, the required headwater is computed by assuming that the culvert inlet acts as an orifice or a weir. Therefore, the inlet control capacity depends primarily on the geometry of the culvert entrance. Extensive laboratory tests by the National Bureau of Standards, and the Bureau of Public Roads (now, FHWA), and other entities resulted in a series of equations which describe the inlet control

headwater under various conditions. These equations are used in computing the headwater associated with inlet control.

Outlet Control Computations

For outlet control flow, the required headwater must be computed considering several conditions within the culvert and the downstream tailwater. For culverts flowing full, the total energy loss through the culvert is computed as the sum of friction losses, entrance losses, and exit losses. Friction losses are based on Manning's equation. Entrance losses are computed as a coefficient times the velocity head in the culvert at the upstream end. Exit losses are computed as a coefficient times the change in velocity head from just inside the culvert (at the downstream end) to outside the culvert.

When the culvert is not flowing full, the direct step backwater procedure is used to calculate the profile through the culvert up to the culvert inlet. An entrance loss is then computed and added to the energy inside the culvert (at the upstream end) to obtain the upstream energy (headwater). For more information on the hydraulics of culverts, the reader is referred to Chapter 6 of the HEC-RAS Hydraulics Reference manual and the Federal Highway Administrations (FHWA) publication *Hydraulic Design of Highway Culverts* (FHWA Publication No. FHWA-NHI-01-020, May 2005).

User-Defined Cross Sections

Selecting **USER-DEFINED** as the channel shape allows you to select an already defined user-defined cross section geometry from the drop-down list. Clicking the browse button will display the Irregular Cross Sections dialog box, allowing you to define the irregular channel geometry, or view those that have already been defined. The Irregular Cross Sections dialog box is described on page 211.

Invert Elevations or Offsets



The software allows you to work in either elevation or depth mode. Working in elevation mode causes all input data to be entered as elevations (e.g., pipe inlet invert elevation). Working in depth mode causes some input data to be entered as a depth offset from the element invert (e.g., pipe inlet invert offset). Elevation is the default mode. Note that this is controlled by the entry **ELEVATION TYPE** in the Project Options dialog box, General tab, described on page 166.

Inflow and Outflow Pipe Invert Elevations

Backwater surcharging can occur where smaller diameter pipes connect to larger diameter pipes and when the pipes have the same invert elevation. This typically happens along a main line sewer as the pipe size increases downstream and at connections of tributary and main line sewers. To reduce the potential for surcharging and backwatering, the following two options are generally used:

- Crown (top of pipe) elevation of the smaller upstream pipe is matched to the crown elevation of the larger downstream pipe
- Crown elevation of the smaller upstream pipe is above the crown elevation of the larger downstream pipe by the amount of loss in the access hole (this practice is often referred to as *hanging the pipe on the hydraulic gradeline*)

To assist you in setting these elevations, two elevation assignment buttons are provided adjacent to the **INVERT ELEVATION** data fields:

- Clicking the  button will cause the pipe invert elevation to be set equal to the connecting node invert elevation. If the link is an open channel element (i.e., not a pipe link) and the node being connected to is a storm drain inlet, selecting this button will cause the channel invert to match the rim (i.e., top) elevation of the inlet (the software assumes that this link element is a curb and gutter link).
- Clicking the  button will cause the pipe invert elevation to be set so that the crown (top) of the pipe matches the crown of the largest diameter pipe that already connects to that same junction.

If working in depth mode, then the above two buttons will be grayed out (i.e., unavailable).

Globally Assigning Link Invert Elevations

From the Conveyance Links dialog box, clicking the Inverts button will display the Assign Link Invert Elevations dialog box as shown in the following figure. The Assign Link Invert Elevations dialog box can be used to globally assign invert elevations to channel, pipe, and culvert links within the network, allowing you to quickly get a model up and running.

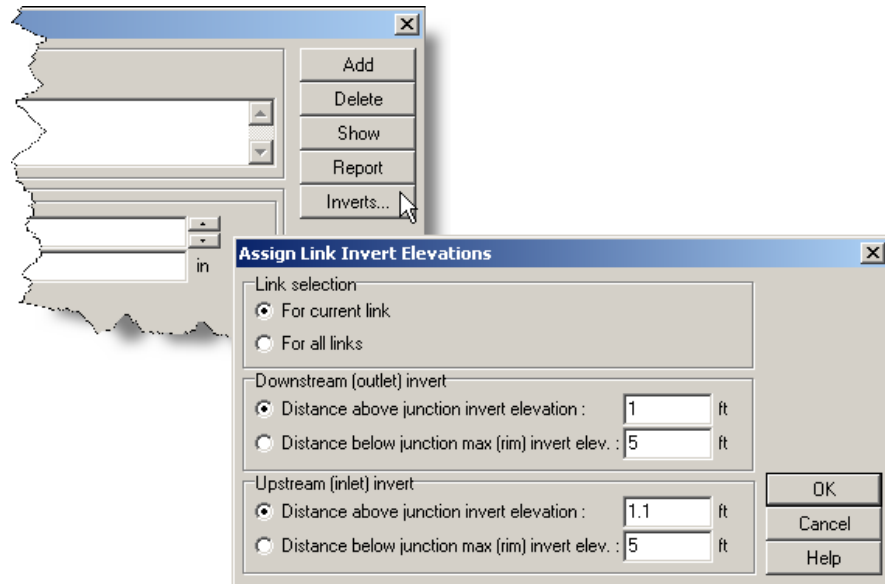

Figure 7.6 The Assign Link Invert Elevations dialog box allows you to globally assign invert elevations for all channel and pipe links within the network

Alternatively, select **DESIGN ► ASSIGN LINK INVERT ELEVATIONS** to display the Assign Link Invert Elevations dialog box. When this dialog box is called from the Design Menu, then the command applies to all links.

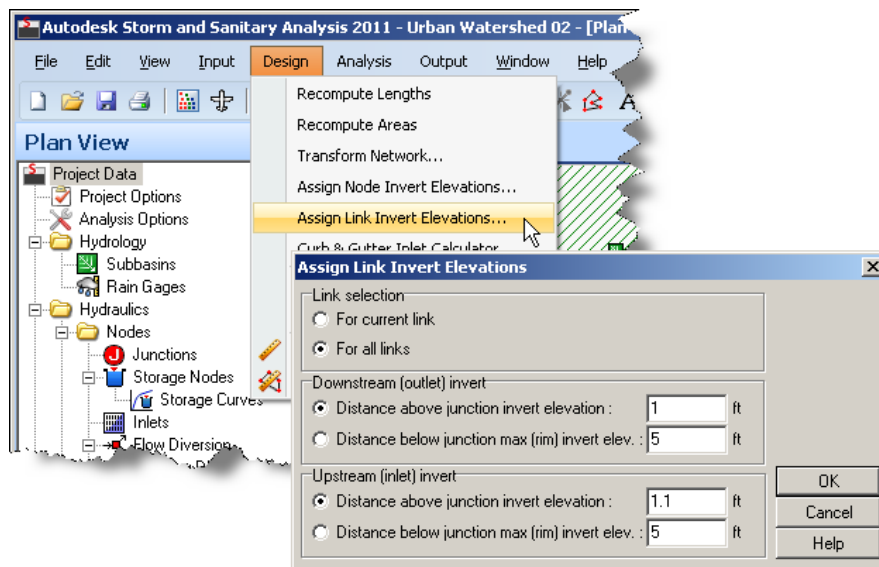

Figure 7.7 The Assign Link Invert Elevations dialog box can also be accessed from the Design Menu

Minimum Flow Velocity and Pipe Grades

It is desirable to maintain a self-cleaning velocity in the storm drain to prevent deposition of sediments and subsequent loss of capacity. For this reason, storm drains should be designed to maintain full-flow pipe velocities of 3 ft/s (1 m/s) or greater. This criteria results in a minimum flow velocity of 2 ft/s (0.6 m/s) at a flow depth equal to 25% of the pipe diameter.

Hydraulic Head Losses

As stormwater first enters the sewer system at the storm drain inlet until it discharges at the outlet, it will encounter many different hydraulic structures, such as manholes, pipe bends, pipe contractions, enlargements, and other transitions that will cause velocity headloss of the flow. These headlosses are termed "minor losses", which is actually a misleading term. In some instances, these headlosses have as much impact as pipe friction. The software provides look-up tables for both entrance and exit headloss coefficients that can be used for most typical sewer elements.

Minimum and Maximum Pipe Cover

Both minimum and maximum cover limits must be considered in the design of storm drainage systems. Minimum cover limits are established to ensure the conduits structural stability under live and impact loads. With increasing fill heights, dead load becomes the controlling factor. For highway applications, a minimum cover depth of 3.0 ft (0.9 m) should be maintained where possible. In cases where this criteria cannot be met, the storm drains should be evaluated to determine if they are structurally capable of supporting imposed loads. Procedures for analyzing loads on buried structures are outlined in the *Handbook of Steel Drainage and Highway Construction Products* and the *Concrete Pipe Design Manual*. However, in no case should a cover depth less than 1.0 ft (0.3 m) be used. As

indicated above, maximum cover limits are controlled by fill and other dead loads. Height of cover tables are typically available from state highway agencies. Procedures in the previous described technical references can be used to evaluate special fill or loading conditions.

Note that the software will report the minimum pipe cover in its output report in the junction section.

Storm Sewer Pipe Alignment

Where possible, storm sewer pipes should be straight between access holes. However, curved storm sewer pipes are permitted where necessary to conform to street layout or avoid obstructions. Pipe sizes smaller than 4.0 ft (1200 mm) should not be designed with curves. For larger diameter storm sewer pipes, deflecting the joints to obtain the necessary curvature is not desirable except in very minor curvatures. Long radius bends are available from many suppliers and are the preferable means of changing direction in pipes 4.0 ft (1200 mm) in diameter and larger. The radius of curvature specified should coincide with standard curves available for the type of material being used.

Storm Drain Run Lengths

The length of individual storm drain runs is dictated by storm drainage system configuration constraints and structure locations. Storm drainage system constraints include inlet locations, access hole and junction locations, etc. Where straight runs are possible, maximum run length is generally dictated by maintenance requirements. The following table identifies maximum suggested run lengths for various pipe sizes.

Table 7.7 Access Hole Spacing Criteria

Pipe Size		Suggested Maximum Spacing	
(inches)	(mm)	(ft)	(m)
12 - 24	300 - 600	300	100
27 - 36	700 - 900	400	125
42 - 54	1000 - 1400	500	150
60 (and up)	1500 (and up)	1000	300

Source: US DOT Federal Highway Administration (August 2001) Hydraulic Engineering Circular No. 22, Second Edition, Urban Drainage Design Manual

Adverse Slope

For both Steady Flow or Kinematic Wave routing, all channels, pipes, and culverts must have positive slopes (i.e., the outlet invert must be below the inlet invert). The software will check for this condition when it performs the analysis, and will report this as a problem.

If you have incorrectly defined the inlet and outlet nodes for a link, you can easily correct this. Select the reversed link in the Conveyance Links dialog box and click the Swap button. The software will reverse the direction of the link so that the outlet node becomes the inlet node and the inlet node becomes the outlet node. Alternatively, select the link from the Plan View, right-click to display the context menu, and select **REVERSE DIRECTION**.

However, if a channel, pipe, or culvert does have an adverse slope (i.e., negative slope), where the outlet elevation is higher than the inlet elevation, reversing the direction of the link will not solve this issue. Networks with adverse sloped links can only be analyzed with Hydrodynamic routing.

Surcharged Pipes and Oscillations

If the upstream end of a pipe surcharges, then a head adjustment is performed by the routing engine at the upstream connecting node. Because this head adjustment is an approximation, the computed head at the upstream node can sometimes have a tendency to “bounce” up and down (or oscillate) when the pipe first surcharges. This bouncing can sometimes cause the analysis results to become unstable; therefore, a transition function is automatically used to smooth the changeover of head computations.

If you find that the oscillation continues at the upstream node while the connected downstream pipe is surcharged, then define a **PONDED AREA** at the downstream connecting node. This can sometimes eliminate the oscillation at the upstream node and produce a more stable model. Additional tips for troubleshooting an unstable model is provided in the section titled *Troubleshooting a Model* on page 85.

Custom Pipe Geometry

The Custom Pipe Geometry dialog box, as shown in the following figure, is displayed when a new user-defined pipe geometry is created or an existing user-defined pipe geometry is selected for editing. The Custom Pipe Geometry dialog box is typically displayed by clicking the (...) browse button from the Conveyance Links dialog box (see page 187) when defining a custom pipe geometry, selecting **INPUT ► CUSTOM PIPE GEOMETRY**, or double-clicking the **CUSTOM PIPE GEOMETRY** icon from the data tree.

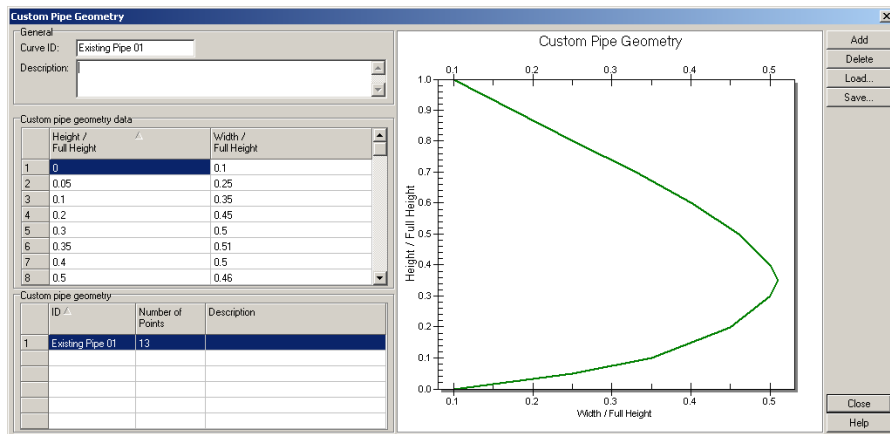

Figure 7.8 The Custom Pipe Geometry dialog box

To select a custom pipe geometry, scroll through the displayed table of defined custom pipes and click the row containing the custom pipe of interest. The data entry fields will then display the information describing the selected custom pipe. To add a new custom pipe geometry, click the Add button and then enter the appropriate information in the data fields. To delete a custom pipe, select the custom pipe from the table and then click the Delete button.

The following values are used to define the custom pipe:

Pipe Geometry ID

Enter the unique name (or ID) that is to be assigned to the custom pipe being defined. This name can be alphanumeric (i.e., contain both numbers and letters), can contain spaces, is case insensitive (e.g., *ABC = abc*), and can be up to 128 characters in length. Therefore, the assigned name can be very descriptive, to assist you in identifying different custom pipe geometries.

Description (optional)

Enter an optional description that describes the custom pipe being defined.

Height / Full Height

Width / Full Height

This table is used to define the height and width geometry data describing the custom pipe shape. This shape specifies how the width of the pipe cross-section varies with height, where both width and height are scaled relative to the pipe's maximum height. This allows the same pipe shape to be used for pipes of differing sizes. Therefore, this geometry is entered as unitless data.

The column labeled **HEIGHT / FULL HEIGHT** varies from a value of 0.0 to 1.0 and should be entered in increasing order. Note that two height values can have the same value in order to represent a horizontal segment of the custom pipe geometry. A value of 0.0 represents the invert of the pipe and a value of 1.0 represents the crown of the pipe.

The column labeled **WIDTH / FULL HEIGHT** is used to define the width of the pipe scaled relative to the full height of the pipe.



Right-Click Context Menu

Right-click the data table to display a context menu. This menu contains commands to cut, copy, insert, and paste selected cells in the table as well as options to insert or delete rows. The table values can be highlighted and copied to the clipboard for pasting into Microsoft Excel. Similarly, Excel data can be pasted into the table of height versus width.

Importing and Exporting Custom Pipe Geometry Data

Click the Load button to import a custom pipe geometry that was previously saved to an external file or click the Save button to export the current custom pipe geometry to an external file.

Irregular Cross Sections

The Irregular Cross Sections dialog box, as shown in the following figure, is displayed when a new user-defined cross section is created or an existing user-defined cross section is selected for editing. The Irregular Cross Sections dialog box is typically displayed by clicking the  browse button from the Conveyance Links dialog box (see page 187) when defining an irregular cross section, selecting **INPUT ► IRREGULAR CROSS SECTIONS**, or double-clicking the **IRREGULAR CROSS SECTIONS**  icon from the data tree.

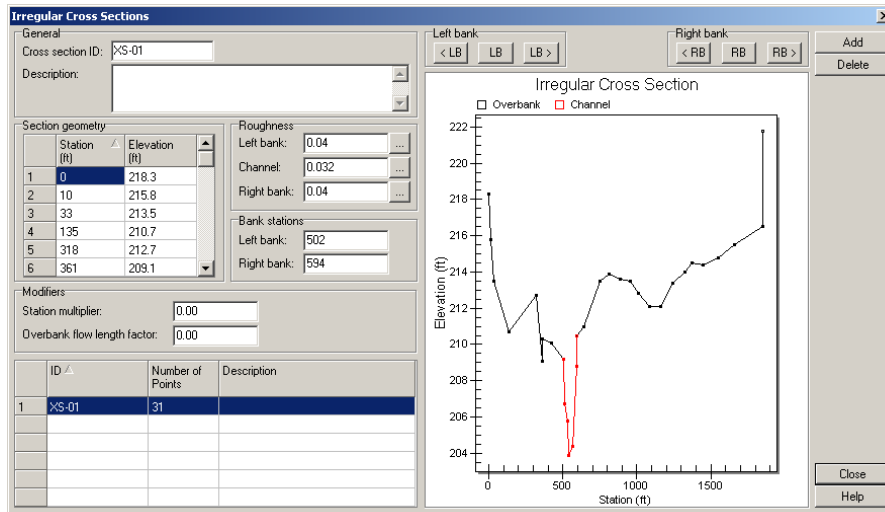

Figure 7.9 The Irregular Cross Sections dialog box

To select a cross section, scroll through the displayed table of defined cross sections and click the row containing the cross section of interest. The data entry fields will then display the information describing the selected cross section. To add a new cross section, click the Add button then enter the appropriate information in the data fields. To delete a cross section, select the cross section from the table and then click the Delete button.

The following values are used to define the irregular cross section data:

Cross Section ID

Enter the unique name (or ID) that is to be assigned to the cross section being defined. This name can be alphanumeric (i.e., contain both numbers and letters), can contain spaces, is case insensitive (e.g., *ABC = abc*), and can be up to 128 characters in length. Therefore, the assigned name can be very descriptive, to assist you in identifying different cross sections.

Description (optional)

Enter an optional description that describes the cross section being defined.

Station / Elevation Geometry

This table is used to define the station and elevation geometry data describing the cross section. Station and elevation data are entered in feet (for US units) or meters (for SI metric units). By convention, the cross section stationing (x-coordinates) are entered from left to right looking in the downstream direction. Cross section stationing must be in increasing order. However, two or more stations can have the same value to represent a vertical wall. Up to 1,500 data points can be entered.

Right-click the data table to display a context menu. This menu contains commands to cut, copy, insert, and paste selected cells in the table as well as options to insert or delete rows.

Note that the cross section elevation data is internally adjusted up or down so that the cross section invert matches the **INLET INVERT ELEVATION** and **OUTLET INVERT ELEVATION** values defined in the Conveyance Links dialog box (see page 187). Therefore, a template cross section can be created, and internally the software will adjust the defined cross section elevation data to match the invert elevation defined for the link that the cross section is assigned to.

Roughness

These entries define the Manning's roughness for the left overbank, right overbank, and main channel portion of the cross section. The overbank roughness values can be zero if no overbank exists.

Clicking the browse button will display a reference dialog box showing Manning's roughness coefficients, allowing you to determine the appropriate roughness coefficient to be used for the cross section.

Left Bank Station

Right Bank Station

These entries define the stationing (distance values appearing in the Station/Elevation data) that correspond to the left and right overbank locations. Station values must correspond to a defined cross section station value.

Clicking the and buttons cause the bank stations to move to the next left station. Clicking the and buttons cause the bank stations to move to the next right station. Clicking the and buttons allow you to interactively locate the overbank stations by clicking the station in the cross section plot window.

Use a 0 value to denote the absence of floodplain overbank areas.

Station Multiplier

This entry is a scaling factor by which the distance between each station will be multiplied when the cross section data is processed during the routing computations. A value less than 1.0 causes the cross section geometry to shrink horizontally, a value greater than 1.0 causes the cross section geometry to expand horizontally. Use a value of 0 (or leave blank) if no such scaling factor is needed.

This entry can be used in order to scale an already existing cross section to fit a different location along a routing reach. Create a copy of an existing cross section and then scale the stationing using this multiplier.

Overbank Flow Length Factor

This entry is a scaling factor which is used to determine the overbank conveyance flow length from the previously defined channel conveyance flow length. The **LENGTH** value defined in the Conveyance Links dialog box (see page 195) represents the hydraulic conveyance flow length (ft or m) of the main channel. Therefore, this factor represents the ratio of the conveyance flow length of the meandering main channel to the overbank area that surrounds it. For example, if the main channel flow length is 1200 ft and the overbank flow length is 1000 ft, the scaling value entered would be 1.2 (1200 ft/1000 ft).

A value of 1.0 represents that the main channel and overbank conveyance flow lengths are the same. Use a value of 0 (or leave blank) if no scaling is needed. This scaling factor is applied to all open channel reaches that use the defined cross section.

Right-Click Context Menu

Right-click the data table to display a context menu. This menu contains commands to cut, copy, insert, and paste selected cells in the table as well as options to insert or delete rows. The table values can be highlighted and copied to the clipboard for pasting into Microsoft Excel. Similarly, Excel data can be pasted into the table of station and elevation data.

Irregular Cross Section Elevations

The irregular shaped conduit effectively rests on the channel link invert elevations defined at the inlet and outlet nodes specified in the Conveyance Links dialog box (see page 187). The elevation data specified for the irregular cross section geometry has no effect on the hydraulic computations. The computed head for an irregular shaped channel link is based on the shape of the cross section, rather than the actual elevations defined for the cross section data (i.e., the relative elevations rather than the absolute elevations). The software normalizes the irregular cross section geometry elevation data as depth values. As such, only the channel link's upstream and downstream invert elevations have an effect on the hydraulic computations as they change the channel slope of the open channel link.

Extended Stream Reaches

If a stretch of stream or river is to be modeled, then characteristic cross sections should be defined, with junctions between them to denote where the cross section reaches change in geometry.

Junctions



Junctions commonly represent manholes in an urban stormwater or sanitary sewer system. However, junctions can also represent locations along an open channel reach where there is a change in channel slope or cross section geometry. Junctions also represent locations where channels and pipes join together.

Computationally, junctions are nodal locations within the drainage network where subbasin runoff is assigned, as well as sanitary sewer loadings and other external inflows are defined. Physically, junctions can represent the confluence of natural surface channels, manholes in a sewer system, or pipe connection fittings. External inflows can enter the drainage network at junctions. Excess water at a junction can become partially pressurized while connecting pipes are surcharged, and the excess water can either be lost from the system or be allowed to pond atop the junction and subsequently drain back into the junction.

In a stormwater or sanitary sewer system, manholes are typically located at sewer junctions (e.g., tees, wyes, and crossings), upstream sewer terminations, and where there are changes in sewer grade or direction. However, manholes (junctions) are also located to provide access for manual inspection, maintenance, and possible emergency service. However, not every manhole in a stormwater or sanitary sewer system needs to be defined in a defined network model—only those junctions necessary to adequately define the hydraulic characteristics of the network.

The principal input parameters for a junction are:

- Invert elevation
- Rim elevation
- Ponded surface area when flooded (*optional*)
- External inflow data (*optional*)

The Junctions dialog box, as shown in the following figure, is displayed when an existing junction is selected for editing by double-clicking it in the Plan View using the **SELECT ELEMENT**  tool. Also, you can choose **INPUT > JUNCTIONS** or double-click the **JUNCTIONS**  icon from the data tree to display the Junctions dialog box.

Junctions

General
Junction ID: 10

Flow properties
External inflows: NO
Treatments: NO

Description:

Physical properties
Invert elevation: 995 ft
Surcharge elev.: 1002 ft
Max/rim elev.: 1002 ft
Ponded area: 0 ft²
WSEL initial: 995 ft

Analysis summary
Max water depth: 7.00 ft
Peak inflow: 9.54 cfs
Max water elevation: 1002.00 ft
Max flooded overflow: 2.66 cfs
Total flooded vol.: 0.49 ac-in
Total time flooded: 11 min

	ID ▲	Invert Elev.	Max/Rim Elev.	WSEL Initial	Sur. Elev.	Ponded Area	Lateral Inflows	Treatments
1	9	1000	1007	1000	1007	0	NO	NO
2	10	995	1002	995	1002	0	NO	NO
3	13	995	1002	995	1002	0	NO	NO
4	14	990	997	990	997	0	NO	NO
5	15	987	994	987	994	0	NO	NO
6	16	985	992	985	992	0	NO	NO

Buttons: Delete, Show, Report, Close, Help

Figure 7.10 The Junctions dialog box

To select a junction, scroll through the displayed table and click the row containing the junction of interest. The provided data entry fields will then display information describing the selected junction.

A new junction is added interactively on the Plan View using the **ADD JUNCTION**  tool. To delete an existing junction, select the junction from the table and then click the Delete button. Click the Show button to zoom to a region around the currently selected junction in the Plan View, and then highlight the junction. Click the Report button to generate a Microsoft Excel report detailing all currently defined junction input data and any corresponding analysis results.

The following illustration details the input data required to define a junction within the software.

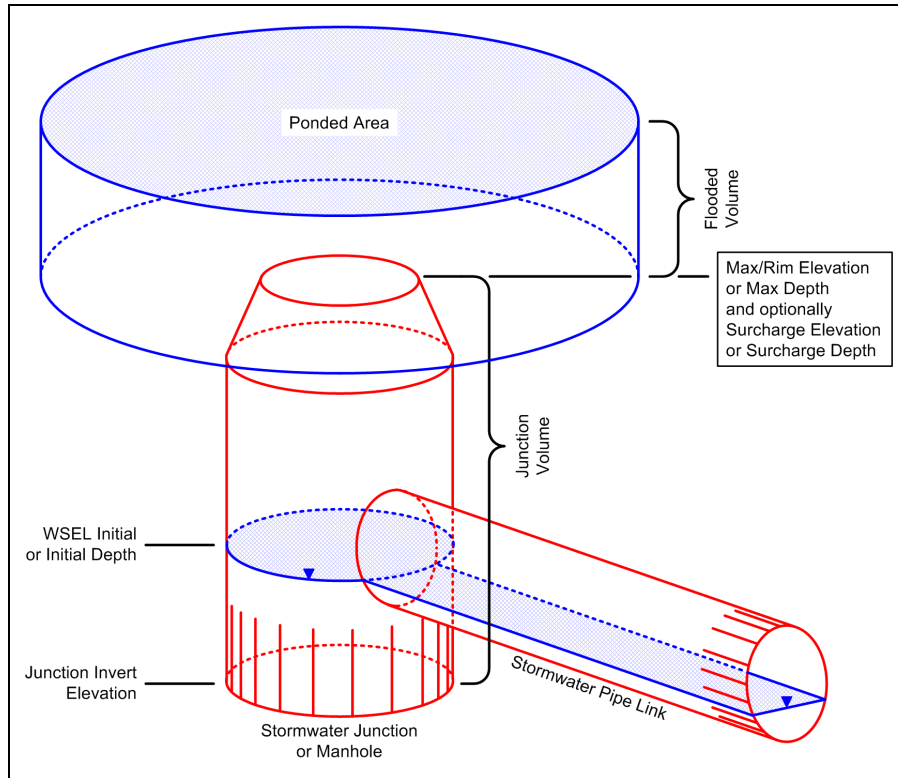

Figure 7.11 The input data used to define a junction

The following data are used to define a junction:

Junction ID

Enter the unique name (or ID) that is to be assigned to the junction being defined. This name can be alphanumeric (i.e., contain both numbers and letters), can contain spaces, is case insensitive (e.g., *ABC = abc*), and can be up to 128 characters in length. Therefore, the assigned name can be very descriptive, to assist you in identifying different junctions.

A new junction ID is automatically defined by the software when a new junction is added. However, the junction ID can be changed within this field.

When importing (or merging) multiple stormwater network models into a single model, the software will check for collisions between identical junction IDs and can automatically assign a new junction ID for any elements being imported that contain the same junction ID as already exist in the network model. See the section titled *Merging Network Models* on page 494 for more information.

Description (optional)

Enter an optional description that describes the junction being defined.

External Inflows

Click the  browse button to display the External Inflows for Node dialog box, which is described in detail on page 408. The External Inflows for Node dialog box defines the additional inflows entering the junction, such as sanitary inflows. If modeling a river or stream, user-defined inflows can be used to define the baseflow. The following inflow types are available:

- Rainfall dependent infiltrations/inflows (RDII)
- User-defined (direct) inflows
- Dry weather (sanitary) inflows

Treatments

Click the  browse button to display the Pollutant Treatments dialog box, which is described in detail on page 462. The Pollutant Treatments dialog box defines the treatment functions for pollutants entering the junction.

Invert Elevation

This entry defines the bottom elevation of the junction (ft or m) above a common datum. See Figure 7.11 for an illustration of this value.

Max/Rim Elevation (or Maximum Depth)

Elevation of the junction manhole rim (or height of the junction above the junction invert) in ft or m. See Figure 7.11 for an illustration of this value.

WSEL Initial (or Initial Depth)

Elevation of the water in the junction (or depth of water above the junction invert) at the start of the simulation in ft or m. See Figure 7.11 for an illustration of this value.

Surcharge Elevation (or Surcharge Depth)

This entry is used to denote the elevation value (or depth above the junction invert) when pressurized (surcharged) flow changes to flooding overflow (ft or m).

To simulate bolted (sealed) manhole covers and force main connections, then this value should be the specified high enough above the **MAX/RIM ELEVATION** value so that the computed hydraulic gradeline is less than specified value. When the computed hydraulic gradeline is greater than this specified value, flooding is assumed to occur at the node.

Note that if the manhole is to be allowed to overflow and flood, then the node cannot become pressurized and this value should be set equal to the junction invert or 0. Then, when the computed hydraulic gradeline is above the **MAX/RIM ELEVATION**, flooding will occur. Similarly, to simulate a blowout of a manhole cover, this value can be set equal to the specified **MAX/RIM ELEVATION** value.

More information on force mains and bolted manhole covers is discussed in the below section titled *Bolted (Sealed) Manhole Covers* on page 224.

Ponded Area

This entry defines the surface area (ft² or m²) occupied by ponded water atop the junction once the water depth exceeds the rim elevation of the manhole (or junction). If the **ENABLE OVERFLOW PONDING AT NODES** analysis option is turned on in the Project Options dialog box, General tab (see page 177), a non-zero value for this parameter will allow ponded water to be stored and subsequently returned to the drainage system when capacity exists. See Figure 7.11 for an illustration of this value.

Globally Assigning Node Invert Elevations

Select **DESIGN ► ASSIGN NODE INVERT ELEVATIONS** to display the Assign Nodes Invert Elevations dialog box as shown in the following figure. This dialog box allows you to select a pipe run and then have software compute and assign the node invert elevations automatically.

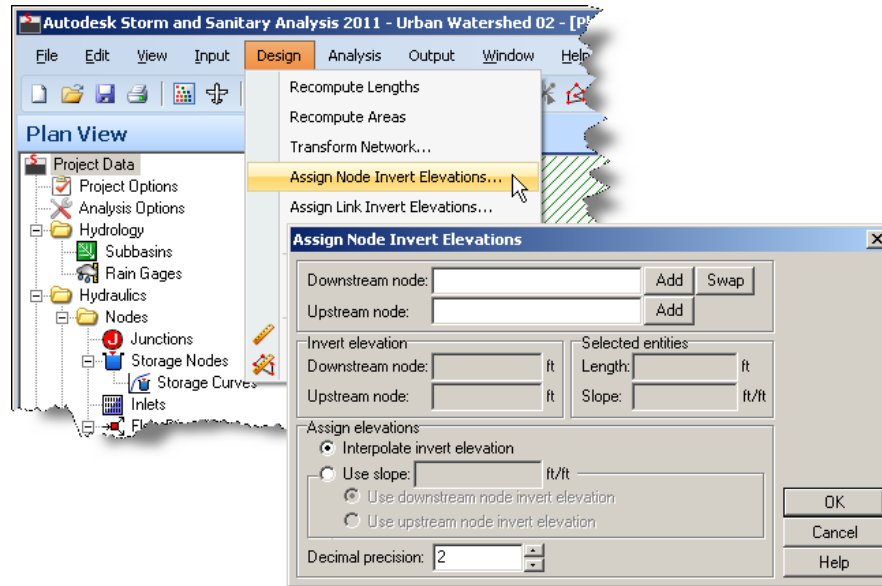

Figure 7.12 The Assign Node Invert Elevations dialog box allows you to assign node invert elevations along a pipe run within the network

Surface Ponding

Typically in flow routing when the flow into a junction exceeds the capacity of the system to transport it further downstream, the excess volume overflows the system and is lost. The software provides an option to have the excess volume be stored atop the junction, in a ponded fashion, and be reintroduced into the system as capacity permits. For both Steady Flow and Kinematic Wave routing, the ponded water is stored simply as an excess volume. For Hydrodynamic Routing, which is influenced by the water depths maintained at nodes, the excess volume is assumed to pond over the node with a constant surface area. This amount of surface area is an input parameter supplied in the Junctions dialog box.

In order to allow excess water to collect atop of junction nodes and be reintroduced into the system as conditions permit, the check box **ENABLE OVERFLOW PONDING AT NODES** in the Project Options dialog box, General tab (see page 177), must be selected as well as a non-zero value for a junction's **PONDED AREA** data field must be specified.

Alternatively, you may wish to represent the surface overflow system explicitly. In open channel systems this can include road overflows at bridges or culvert crossings as well as additional floodplain storage areas. In closed conduit systems, surface overflows may be conveyed down streets, alleys, or other surface routes to the next available stormwater inlet or open channel. Overflows may also be impounded in surface depressions such as parking lots, backyards, or other areas.

Analysis Summary Section

The Junctions dialog box provides a section titled **ANALYSIS SUMMARY** that provides a brief summary of the simulation results for the selected junction, as shown in the following figure.

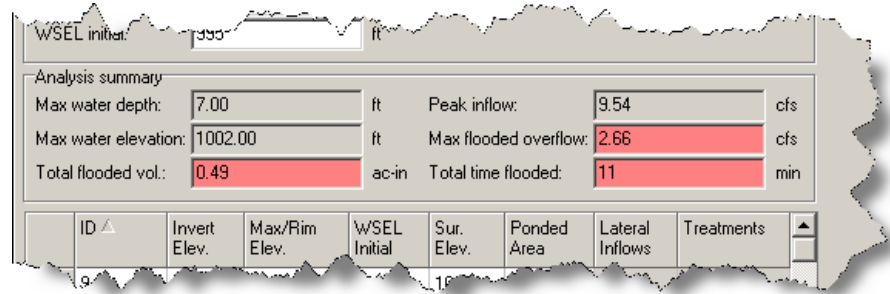

Figure 7.13 The Analysis Summary section of the Junctions dialog box

A description of the available analysis result fields is provided below:

Max Water Depth

This analysis output field provides the maximum water depth that occurred at the junction during the simulation period.

Max Water Elevation

This analysis output field provides the maximum water elevation that occurred at the junction during the simulation period.

Total Flooded Volume

This analysis output field provides the total volume of water that flooded out of (or ponded above) the junction during the simulation period. This water may or may not have re-entered the junction when the flooding subsided—depending upon the analysis options selected. See the section titled *Surface Ponding* on page 218 for more information.

Peak Inflow

This analysis output field provides the maximum flow rate of water entering the junction during the simulation period.

Max Flooded Overflow

This analysis output field provides the maximum flow rate of water flooding (or ponding) from the junction during the simulation period.

Total Time Flooded

This analysis output field provides the time, in minutes, that a junction was flooded.

Note that flooding and surcharging conditions are also displayed on the Plan View by coloring the junction nodes as **BLUE** or **RED** to denote flood or surcharge conditions, as shown in the following figure. Additional options for displaying of flooding and surcharging of links and nodes is described in the section titled *Display Options* on page 25.

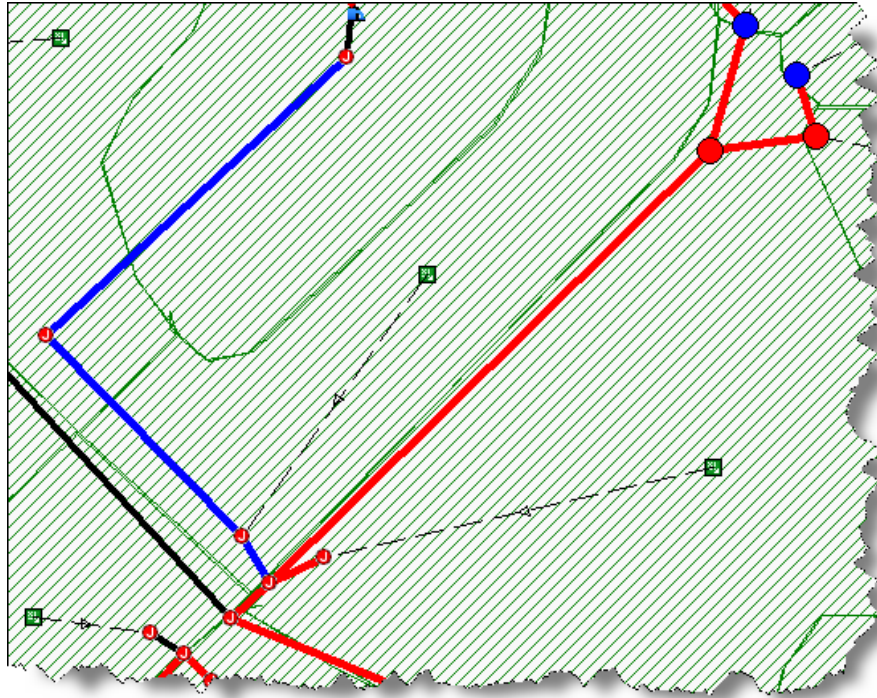

*Figure 7.14 The Plan View will color the junction nodes as **BLUE** or **RED** to denote flood or surcharge conditions*

Modeling Storage Vaults and Other Nodal Storage Structures

Junctions have limited storage volume as nodal elements within a network model, and are assumed to have the volume only of a common manhole. This storage volume defaults to a 4 ft diameter circular manhole, and is defined by the entry **JUNCTION SURFACE AREA** in the Analysis Options dialog box, General tab, described on page 74. Therefore, if it is necessary to model an underground storage vault or other nodal element with significant storage properties, use a storage node element. A storage node can model more than just commonplace ponds—they can model any nodal element that has particular storage properties—such as junction boxes. However, if the node’s storage characteristics are similar to that of a junction, it is adequate to represent the node simply as a junction.

Location and Spacing

Access hole location and spacing criteria have been developed in response to storm drain maintenance requirements. Spacing criteria are typically established based on a local regulatory agency’s past experience and maintenance equipment limitations. At a minimum, access holes should be located at the following points:

- Where two or more storm drains converge
- Where pipe sizes change
- Where a change in alignment occurs
- Where a change in grade occurs

Access Hole Depth

The depth required for an access hole will be dictated by the storm drain profile and surface topography. Common access hole depths range from 5 to 13 ft (1.5 to 4.0 m). Access holes which are shallower or deeper than this may require special consideration.

Irregular surface topography sometimes results in shallow access holes. If the depth to the invert is only 2 to 3 ft (0.6 to 0.9 m), all maintenance operations can be conducted from the surface. However, maintenance activities are not comfortable from the surface, even at shallow depths. It is recommended that the access hole width be of the same size as that for greater depths. Typical access hole widths are 4 to 5 ft (1.2 to 1.5 m). For shallow access holes, use of an extra large cover with a 30 or 36 inch (0.7 m or 0.9 m) opening will enable a worker to stand in the access hole for maintenance operations.

Deep access holes must be carefully designed to withstand soil pressure loads. If the access hole is to extend very far below the water table, it must also be designed to withstand the associated hydrostatic pressure or excessive seepage may occur. Since long portable ladders would be cumbersome and dangerous, access must be provided with either steps or built-in ladders.

Junction Head Losses

Junction and manhole headlosses can comprise a significant percentage of the overall losses within a sewer network system. If these losses are ignored or underestimated, the sewer network may surcharge, resulting in basement flooding and/or sewer overflows. Headlosses at junctions are highly dependent upon flow characteristics, manhole junction geometry, and sewer pipe diameters.

In a study of different manhole designs (Marsalek J., "Head Losses at Selected Sewer Manholes," *Environmental Hydraulics Section, Hydraulics Division, National Water Research Institute, Canada Centre for Inland Waters, July 1985*), the following observations were found:

- 1 During pressurized flow, the most important factor was the relative lateral inflow for a junction with more than two pipes. The headlosses increased as the ratio of the lateral discharge to main line discharge increased.

Among the junction geometrical parameters affecting headlosses, the parameters listed below were found to be most influential. Manhole shape and size were found to be minimally influential.
 - Relative pipe sizes
 - Manhole deflectors and benching
 - Pipe alignment
- 2 Full benching to the crown of the pipe were found to significantly reduce headlosses as compared to benching to the mid-section of the pipe or with no benching.
- 3 In junctions with two lateral inflows, the headlosses increased as the difference in flows between the two lateral sewers increased. Headloss was minimized when the lateral flows were relatively equal.

Additional information with respect to junction headloss has been discussed by Chow (Chow, V. T., *Open Channel Hydraulics, McGraw-Hill Book Company, 1959*).

Minimizing Flow Turbulence in Junctions

To minimize flow turbulence in junctions, flow channels and benches are sometimes built into the bottom of access holes. Table 7.8 illustrates several efficient access hole channel and bench geometries.

Table 7.8 Efficient channel and bench configurations for access holes

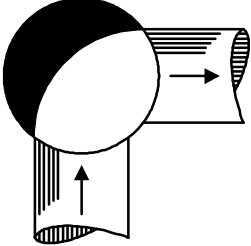
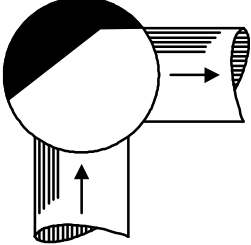
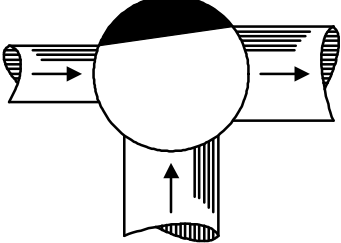
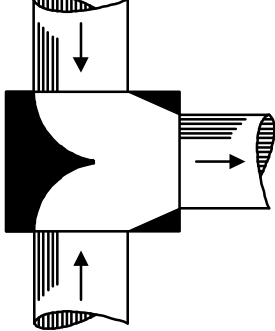
Description	Diagram
Bend with curved deflector	
Bend with straight deflector	
Inline upstream main & 90° lateral with deflector	
Directly opposed laterals with deflector (Head losses will still be excessive with this deflector but are significantly less than with no deflectors)	

Source: US DOT Federal Highway Administration (August 2001) Hydraulic Engineering Circular No. 22, Second Edition, Urban Drainage Design Manual

The purpose of the flow channel is to provide a smooth, continuous conduit for the flow and to eliminate unnecessary turbulence in the access hole by reducing energy losses. The elevated bottom of the access hole on either side of the flow channel is called the bench. The purpose of a bench is to increase hydraulic efficiency of the access hole. The following figure illustrates several efficient junction channel and bench geometries.

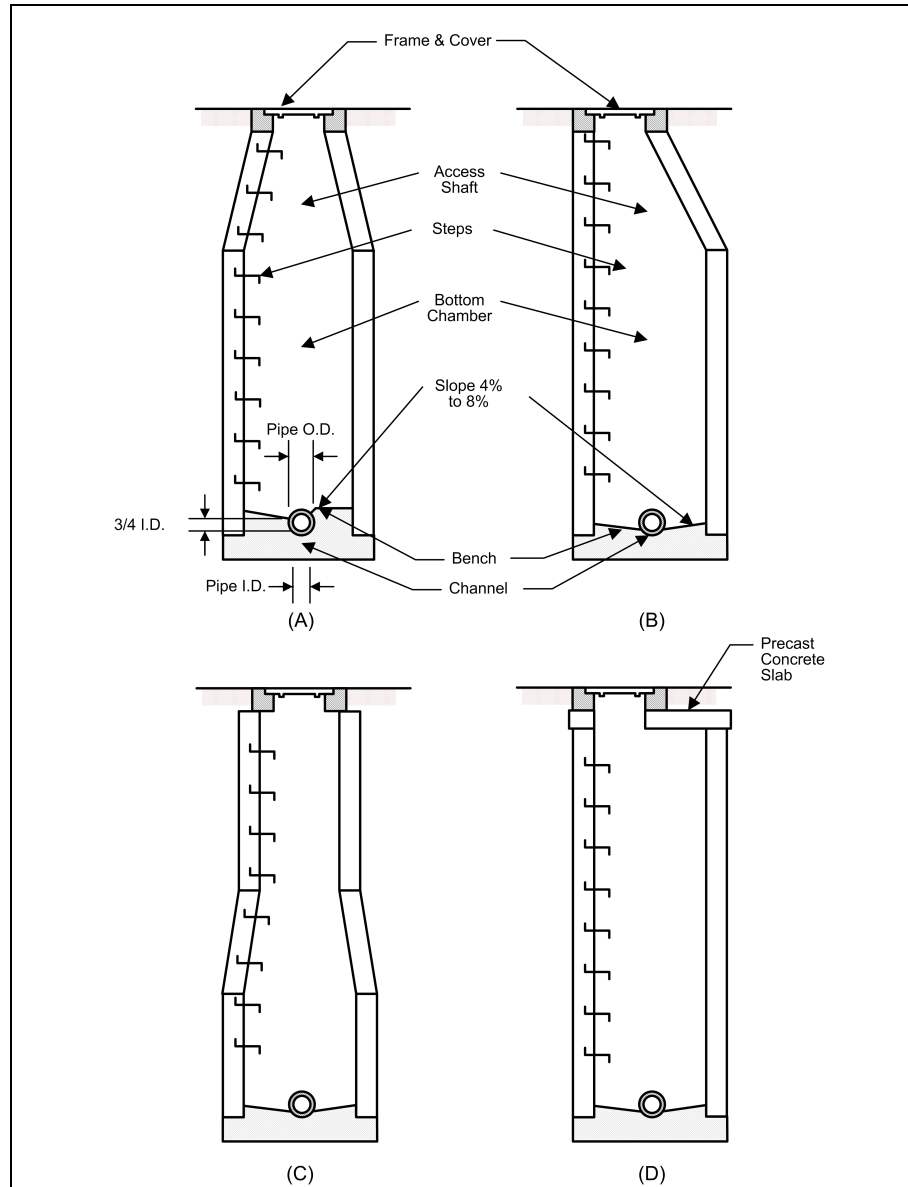

Figure 7.15 Typical access holes configurations (Source: US DOT Federal Highway Administration, August 2001, *Hydraulic Engineering Circular No. 22, Second Edition, Urban Drainage Design Manual*)

In the design of access holes, benched bottoms are not common. Benching is only used when the hydraulic gradeline is relatively flat and there is no appreciable head available. Typically, the slopes of storm drain systems do not require the use of benches to hold the hydraulic gradeline in the correct place. Where the hydraulic gradeline is not of consequence, the extra expense of adding benches should be avoided.

Junction Access Hole Design

Most access holes are circular with the inside dimension of the bottom chamber being sufficient to perform inspection and cleaning operations without difficulty. A minimum inside diameter of 4 ft (1.2 m) has been adopted widely with 5 ft (1.5 m) diameter access hole being used for larger diameter storm drains. The access shaft (cone) tapers to a cast-iron frame that provides a minimum clear opening

usually specified as 22 to 24 inches (0.5 to 0.6 m). It is common practice to maintain a constant diameter bottom chamber up to a conical section a short distance below the top, as shown in Figure 7.15.a. It has also become common practice to use eccentric cones for the access shaft, especially in precast access hole. This provides a vertical side for the steps (Figure 7.15.b) which makes it much easier to access.

Another design option maintains the bottom chamber diameter to a height sufficient for a good working space, then taper to 3 ft (0.9 m) as shown in Figure 7.15.c. The cast iron frame in this case has a broad base to rest on the 3 ft (0.9 m) diameter access shaft. Still another design uses a removable flat reinforced concrete slab instead of a cone, as shown in Figure 7.15.d.

As illustrated in Figure 7.15, the access shaft can be centered over the access hole or offset to one side. The following guidelines are made in this regard:

- For access holes with chambers 3 ft (0.9 m) or less in diameter, the access shaft can be centered over the axis of the access hole.
- For access holes with chamber diameters 4 ft (1.2 m) or greater in diameter, the access shaft should be offset and made tangent to one side of the access hole for better location of the access hole steps.
- For access holes with chambers greater than 4 ft (1.2 m) in diameter, where laterals enter from both sides of the access hole, the offset should be toward the side of the smaller lateral.
- The access hole should be oriented so the workers enter it while facing traffic if traffic exists.

Bolted (Sealed) Manhole Covers

If the hydraulic gradeline can rise above the ground surface at an access hole site, such as in a sanitary force main, special consideration must be given to the design of the access hole frame and cover. The cover must be secured so that it remains in place during peak flooding periods, avoiding an access hole "blowout." A "blowout" is caused when the hydraulic gradeline rises in elevation higher than the access hole cover and forces the lid to explode off. The difference between specified **SURCHARGE ELEVATION** and the **MAX/RIM ELEVATION** should correspond to the maximum or design pressure for the access hole frame and cover. If "blowout" conditions are possible, access hole covers should be bolted or secured in place with a locking mechanism.

A foot of surcharge on a 3 ft diameter manhole cover exerts an upward force of about 441 pounds. It would not take much surcharge to cause the manhole cover securing bolts to fail. In addition, generally a weaker part of the manhole is the connection between the frame and the manhole, between manhole rings, and between manhole riser sections. At some point, the surcharge pressure may even cause unrestrained pipe joints to fail. In practice, it could be easy to envision any of these joints separating enough to relieve the surcharge pressure and then settling back down, leaving little evidence that the surcharge event occurred.

Storm Drain Inlets

The primary function of a storm drain inlet structure is to allow surface water to enter the storm drainage system. As a secondary function, storm drain inlet structures also serve as access points for cleaning and inspection. The materials most commonly used for inlet construction are cast-in-place concrete and pre-cast concrete. Inlet structures are box structures with storm drain inlet openings to

receive surface water. The following figure illustrates several typical storm drain inlet structures including a standard drop inlet, catch basin, curb inlet, and combination inlet.

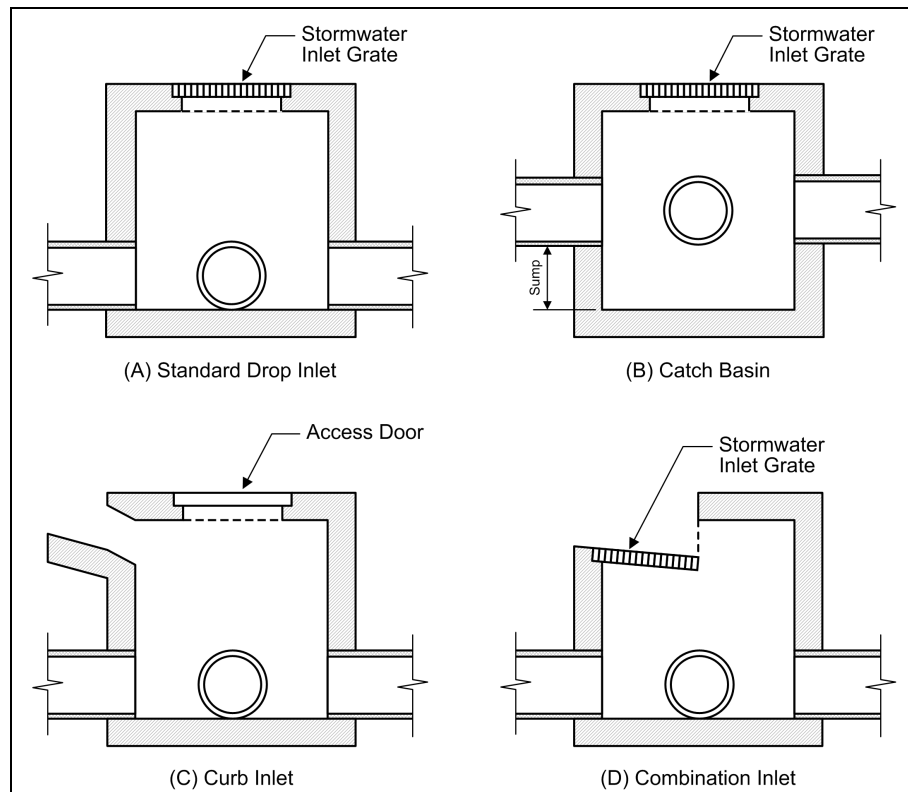

Figure 7.16 Typical inlet structures

The catch basin, illustrated in Figure 7.16.b, is a special type of storm drain inlet structure designed to retain sediment and debris transported by stormwater into the storm drainage system. Catch basins include a sump for the collection of sediment and debris. Catch basin sumps require periodic cleaning to be effective, and may become an odor and mosquito nuisance if not properly maintained. However, in areas where site constraints dictate that storm drains be placed on relatively flat slopes, and where a strict maintenance plan is followed, catch basins can be used to collect sediment and debris but may be ineffective in reducing other pollutant loadings in captured stormwater runoff due to ponding of water in the relatively flat drainage network.

Storm Drain Inlet Types

Storm drain inlets are used to collect runoff and then discharge it to an underground stormwater drainage system. Inlets are typically located in roadway gutter sections, paved medians, and roadside and median ditches. Inlets used for the drainage of highway surfaces can be divided into the following four types:

- Grate inlets
- Curb-opening inlets
- Combination inlets
- Slotted inlets

Grate inlets consist of an opening in the gutter or ditch covered by a grate. Curb-opening inlets are vertical openings in the curb covered by a top slab. Combination inlets consist of both a curb-opening inlet and a grate inlet placed in a side-by-side configuration, but the curb opening may be located partially upstream of the grate. Slotted inlets consist of a pipe cut along the longitudinal axis with bars perpendicular to the opening to maintain the slotted opening. Slotted drains may also be used with grates and each type of inlet may be installed with or without a depression of the gutter. The following figure illustrates each type of inlet.

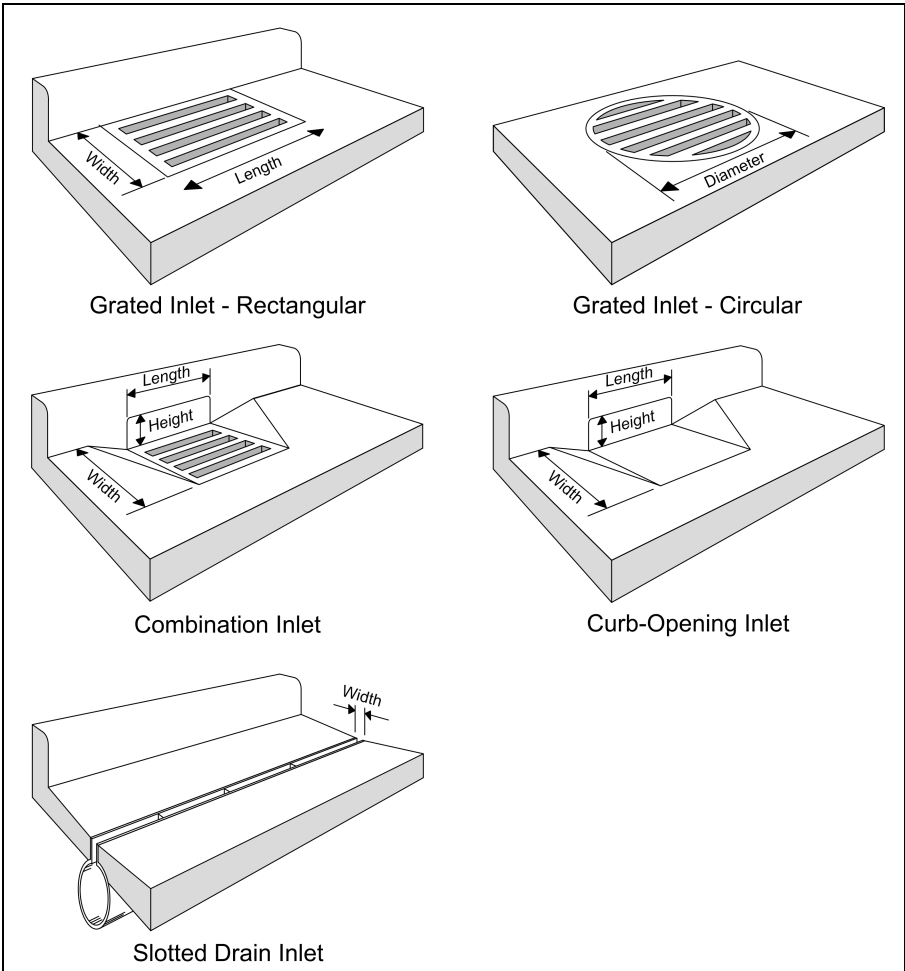

Figure 7.17 Different types of storm drain inlets

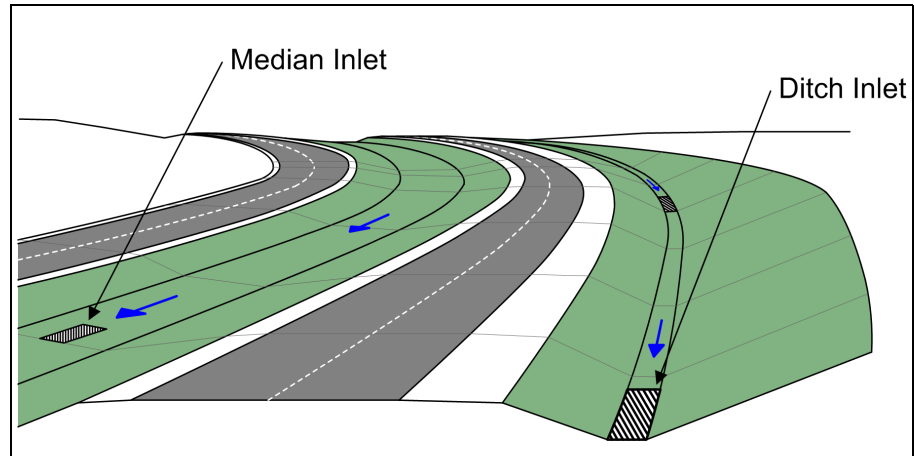

Figure 7.18 Median and ditch inlets

Inlet Characteristics and Uses

Generally *grate inlets* perform satisfactorily over a wide range of gutter grades. Grate inlets will lose capacity with an increase in grade, but to a lesser degree than curb opening inlets. The principal advantage of grate inlets is that they are installed along the roadway where the water is flowing. Their principal disadvantage is that they may be clogged by floating trash or debris. For safety reasons, preference should be given to grate inlets where out-of-control vehicles might be involved. Additionally, where bicycle traffic occurs, grates should be bicycle safe.

Curb-opening inlets are most effective on flatter slopes, in sags, and with flows which typically carry significant amounts of floating debris. The interception capacity of curb-opening inlets decreases as the gutter longitudinal slope steepens. Consequently, the use of curb-opening inlets is recommended in sags and on grades less than 3%. Of course, they are bicycle safe as well.

Combination inlets provide the advantages of both curb opening and grate inlets. This combination results in a high capacity inlet which offers the advantages of both grate and curb opening inlets. When the curb opening precedes the grate in a "Sweeper" configuration, the curb-opening inlet acts as a trash interceptor during the initial phases of a storm. Used in a sag configuration, the sweeper inlet can have a curb opening on both sides of the grate.

Slotted drain inlets can be used in areas where it is desirable to intercept sheet flow before it crosses onto a section of roadway. Their principal advantage is their ability to intercept flow over a wide section. However, slotted inlets are very susceptible to clogging from sediments and debris, and are not recommended for use in environments where significant sediment or debris loads may be present. Slotted inlets on a longitudinal grade do have the same hydraulic capacity as curb openings when debris is not a factor.

Hydraulics of Storm Drain Inlets

Storm drain inlet design is often neglected or receives little attention during the design of a storm drainage system. Inlets play an important role in both road drainage and storm sewer design since they directly impact both the rate of water removal from the roadway and the degree of utilization of the storm drainage system.

If a storm drain inlet is unable to capture the design runoff into the sewer system, roadway flooding and possible hazardous conditions for traffic may occur during a storm event. This can also lead to an overdesign of the sewer pipes downstream of the inlet since the inlet cannot capture the design flow. In some situations, the restricted inlet capacity may be desirable as a stormwater management alternative, thereby offering a greater level of protection from excessive sewer surcharging. In such situations, both the amount of runoff intercepted into the sewer system and also bypassing along the roadway should be computed. Finally, over specification in the number of inlets results in higher construction and maintenance costs, as well as can result in overuse of the sewer system.

Storm drain inlets may not intercept all runoff due to the velocity of flow passing over the inlet and the spread of flow across the roadway and gutter at the inlet location. This leads to bypass (or carryover) flow. As this bypass flow progresses further downstream, it may accumulate resulting in a greater demand for interception. Therefore, it is important that additional emphasis be placed on inlet design to assure that the inlet type, location, and interception capacity are determined to achieve the desired drainage requirements.

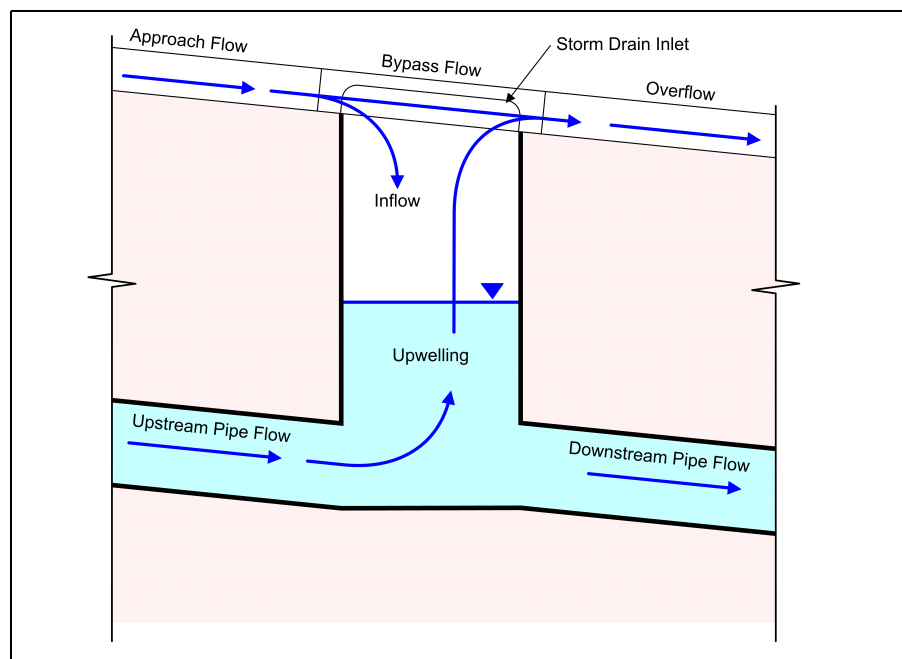

Figure 7.19 The software can model the storm drain inlet approach flows, inflows, bypass flows, upwelling and overflows, as well as upstream and downstream pipe flows

The hydraulic efficiency of storm drain inlets is a function of roadway longitudinal slope (street grade), roadway cross slope, inlet geometry, as well as curb and gutter geometry. Generally, an increased roadway cross slope will result in increased inlet capacity as the flow is concentrated within the gutter. The depth of flow in the gutter is computed by the software. The effect of roadway longitudinal slope on inlet capacity varies. Initially, as the roadway longitudinal slope increases there is an increase in gutter flow velocity, which allows for a greater amount of water to reach the storm drain inlets for interception. However, as the roadway longitudinal slope continues to increase, there is a threshold where the flow velocity is so high that less flow is intercepted. This threshold velocity depends upon the inlet and gutter geometry.

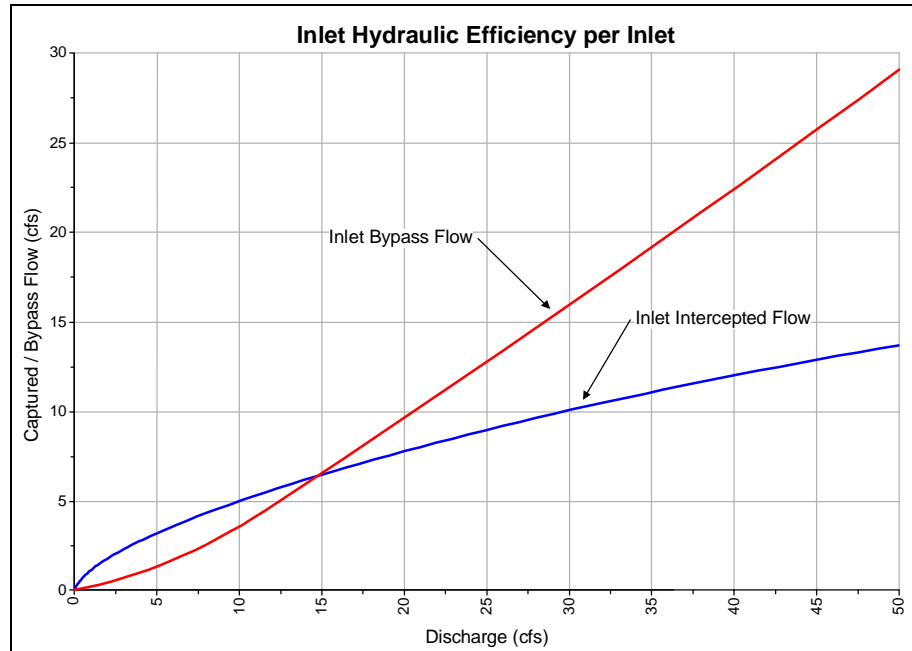

Figure 7.20 As flow increases, more of the stormwater gutter flow starts to bypass the storm drain inlet

In high flow conditions, it may be required to install twin (or double) storm drain inlets to increase the overall inlet capture capacity. To prevent interference with traffic, such installations are generally installed in series, parallel to the curb. Studies (Marsalek, J., "Road and Bridge Deck Drainage Systems," Ministry of Transportation and Communications, Research and Development Branch, Ontario, Canada, Nov. 1982) have shown that when twin storm drain inlets are installed on a continuous grade roadway, the increase in storm drain inlet capacity rarely exceeds 50 percent of a single storm drain inlet.

The capacity of storm drain inlets on a roadway sag is computed by both the weir and orifice equations (FHWA, Vol. 4, "Hydraulic Characteristics of Slotted Drain Inlets," Feb. 1980, Report No. FHWA-RD-79-106, Federal Highway Administration). Flow into the storm drain inlet initially operates as a weir having a crest length equal to the length of drain perimeter that the flow crosses. The storm drain inlet operates under weir conditions to a depth of about 4 inches (100 mm) and then begins to switch to orifice flow.

The slotted drain inlet can be used effectively to intercept runoff from wide, flat areas such as parking lots, highway medians, and airport loading ramps. In these installations, the drain is placed perpendicular to the direction of flow so that the open slot acts as a weir intercepting all of the flow uniformly along the entire length of the drain. For roadways on grade, the slotted drain inlet should be specified to run parallel to the curb and located approximately 3.5 inches (90 mm) from the curb as shown in the following figure. For slotted drain inlets located on sag, the inlet length should be at least 2.0 times the calculated required inlet length to ensure against debris blocking the inlet.

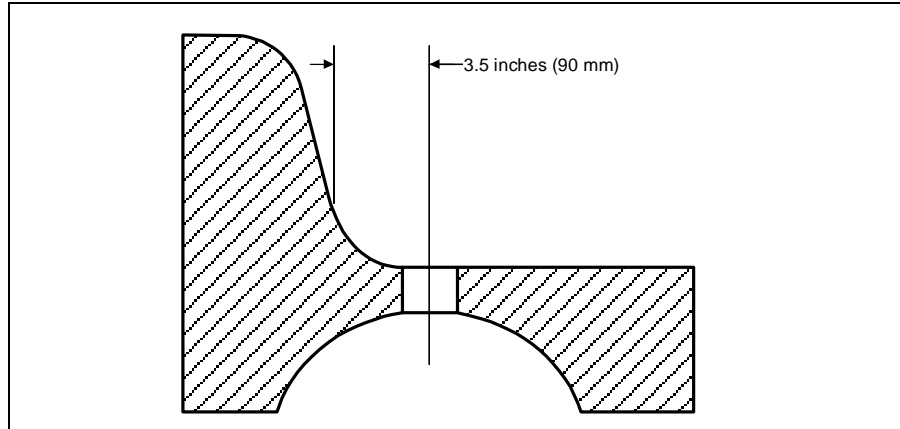

Figure 7.21 Location of slotted drain inlet for roadways

Multiple Drainage Pathways

Generally, the stormwater sewer network and drainage inlets generally provide sufficient capacity to collect and transport stormwater runoff from the 2- to 10-year frequency storm. However, for larger frequency storms (such as the 25- to 100-year storm), excess stormwater may also be carried by streets, creeks, and channels. Therefore, multiple drainage pathways can be defined within the model to allow both the stormwater sewer network and surface routing pathways (i.e., streets, ditches, etc.) to route stormwater. Streets can be defined as surface level drainage channels, allowing stormwater to route downstream along the streets. The model can then compute the stage versus discharge versus gutter spread relationship for a roadway being modeled as a drainage channel.

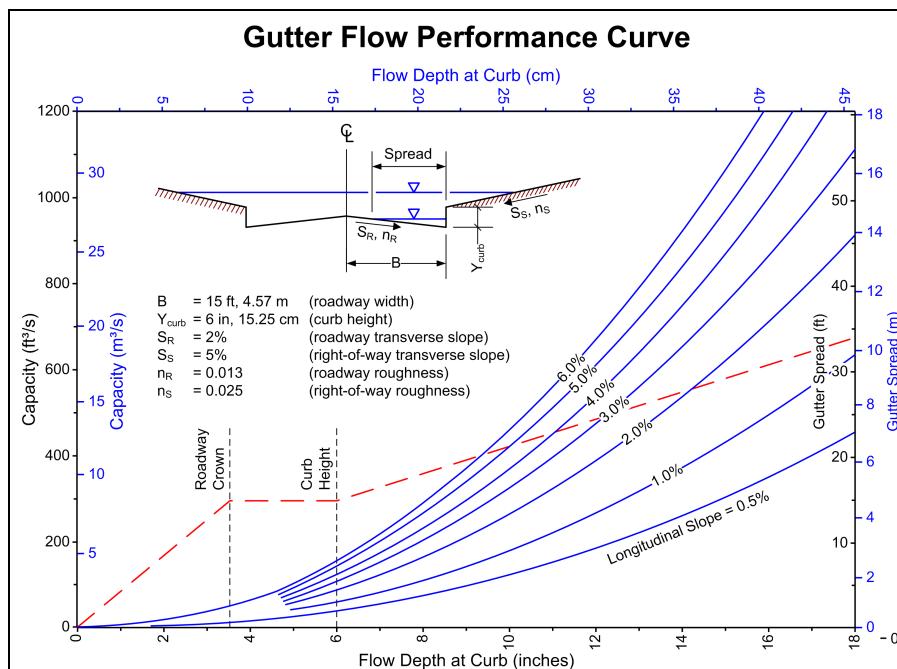

Figure 7.22 Illustration of stage versus discharge versus gutter spread relationship for a roadway being modeled as a drainage channel

Traffic inconvenience associated with street flooding during a major storm event is temporary and would occur anyway. However, the economic benefit is that you

can reduce the stormwater pipe size when selecting the pipe diameter for the required design frequency.

Street flow can change direction at roadway intersections, as well as leave the street and cross overland to other parts of the model at low lying locations. Street routing stormwater can be partially or completely captured at stormwater drainage inlets. Storm sewers can backwater, and flow can reverse out of the stormwater drainage inlets where sewer capacity is not sufficient to contain the amount of stormwater being routed. Using the software, a comprehensive model can be developed to design and analyze the capacity of the urban drainage system.

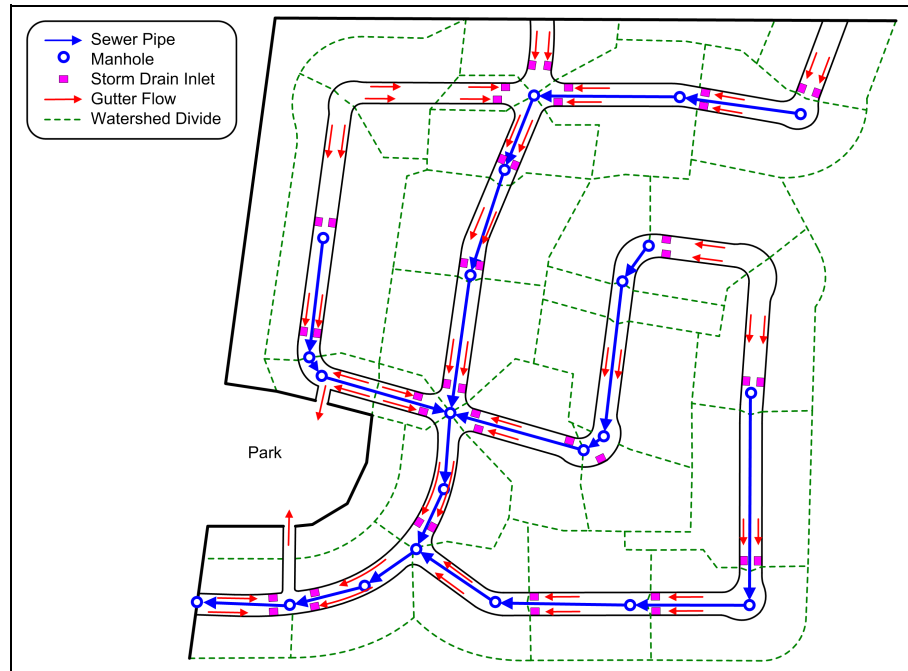



Figure 7.23 Illustration of multiple drainage pathways of a proposed development

In order to model this level of detail within the drainage system, surface routing pathways need to be incorporated within the stormwater network. Roadways can be defined as an open channel routing reach, representing the roadway cross section and the immediate area around the roadway right-a-way. Roadway drainage ditches can also be defined, as well as locations where over capacity stormwater can short-circuit the stormwater network or can exit the system.

Inlets Dialog Box

The Inlets dialog box, as shown in the following figure, is displayed when an existing inlet is selected for editing by double-clicking it in the Plan View using the **SELECT ELEMENT**  tool. Also, you can choose **INPUT > INLETS** or double-click the **INLETS**  icon from the data tree to display the Inlets dialog box.

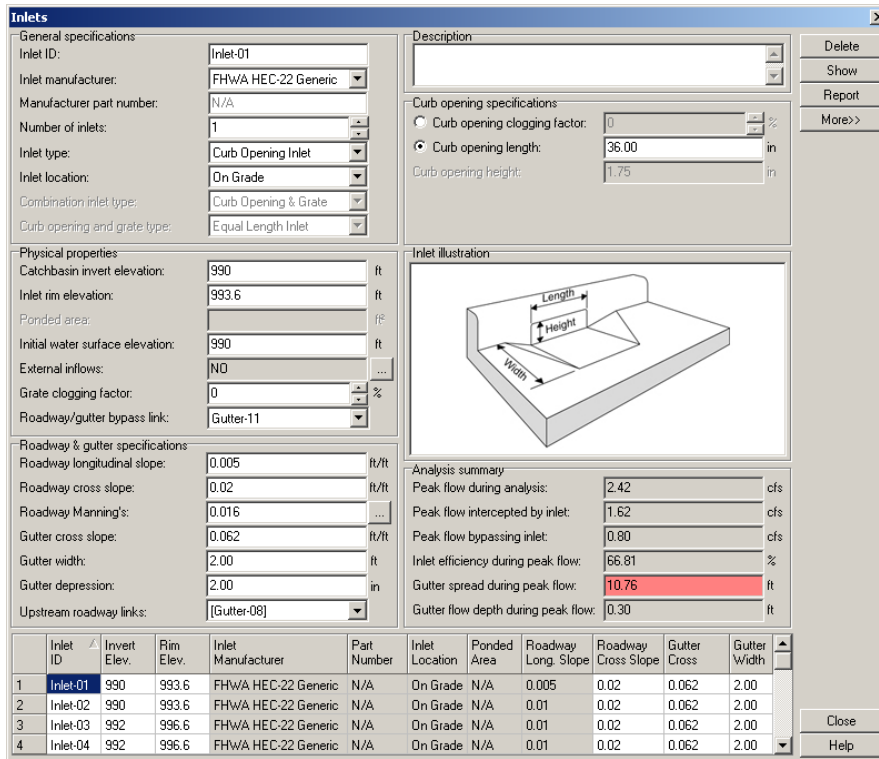



Figure 7.24 The Inlets dialog box

To select a storm drain inlet, scroll through the displayed table and click the row containing the inlet of interest. The provided data entry fields will then display information describing the selected inlet.

A new inlet is added interactively on the Plan View using the **ADD INLET**  tool. To delete an existing inlet, select the inlet from the table and then click the Delete button. Click the Show button to zoom to a region around the currently selected inlet in the Plan View, and then highlight the inlet. Click the Report button to generate a Microsoft Excel report detailing all currently defined storm drain inlet input data and any corresponding analysis results.

The following illustration details the input data required to define a storm drain inlet within the software.

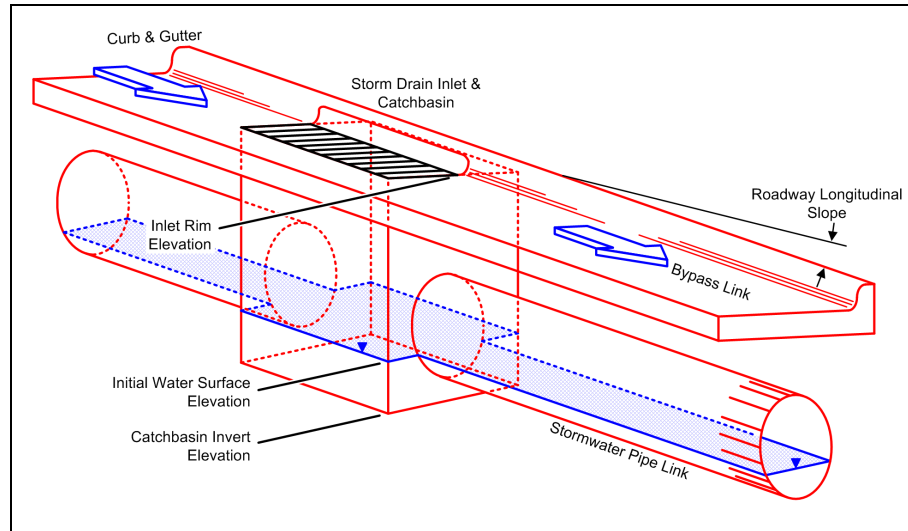

Figure 7.25 The input data used to define a storm drain inlet

The following data are used to define a storm drain inlet:

Inlet ID

Enter the unique name (or ID) that is to be assigned to the storm drain inlet being defined. This name can be alphanumeric (i.e., contain both numbers and letters), can contain spaces, is case insensitive (e.g., *ABC = abc*), and can be up to 128 characters in length. Therefore, the assigned name can be very descriptive, to assist you in identifying different inlets.

A new inlet ID is automatically defined by the software when a new inlet is added. However, the inlet ID can be changed within this field.

When importing (or merging) multiple stormwater network models into a single model, the software will check for collisions between identical inlet IDs and can automatically assign a new inlet ID for any inlets being imported that contain the same inlet ID as already exist in the network model. See the section titled *Merging Network Models* on page 494 for more information.

Description (optional)

Enter an optional description that describes the storm drain inlet being defined.

Inlet Manufacturer

This drop-down list allows you to select the storm drain inlet manufacturer in order to determine the hydraulic characteristics of the inlet. In addition to manufactured inlets, various generic inlets are supported.

Inlet Part Number

After selecting the storm drain inlet manufacturer, this drop-down list provides a list of inlets available from the manufacturer's catalog that hydraulic characteristics are available for.

If **CUTOFF FLOW**, **CAPTURE CURVE**, or **FHWA HEC-22 GENERIC** is selected in the **INLET MANUFACTURER** drop-down list, then this field is grayed out.

Number of Inlets

This spin control specifies how many identical storm drain inlets are being defined at this location. To prevent interference with traffic, multiple inlets are assumed to be installed in series, parallel to the curb.

Inlet Type

If **FHWA HEC-22 GENERIC** is selected in the **INLET MANUFACTURER** drop-down list, then this drop-down list provides a listing of the available inlet types. Otherwise, this field is grayed out. The following **FHWA HEC-22 GENERIC** storm drain inlet types are available:

- Combination Inlet
- Curb Opening Inlet
- Grate Inlet
- Median & Ditch Inlet
- Slotted Drain Inlet

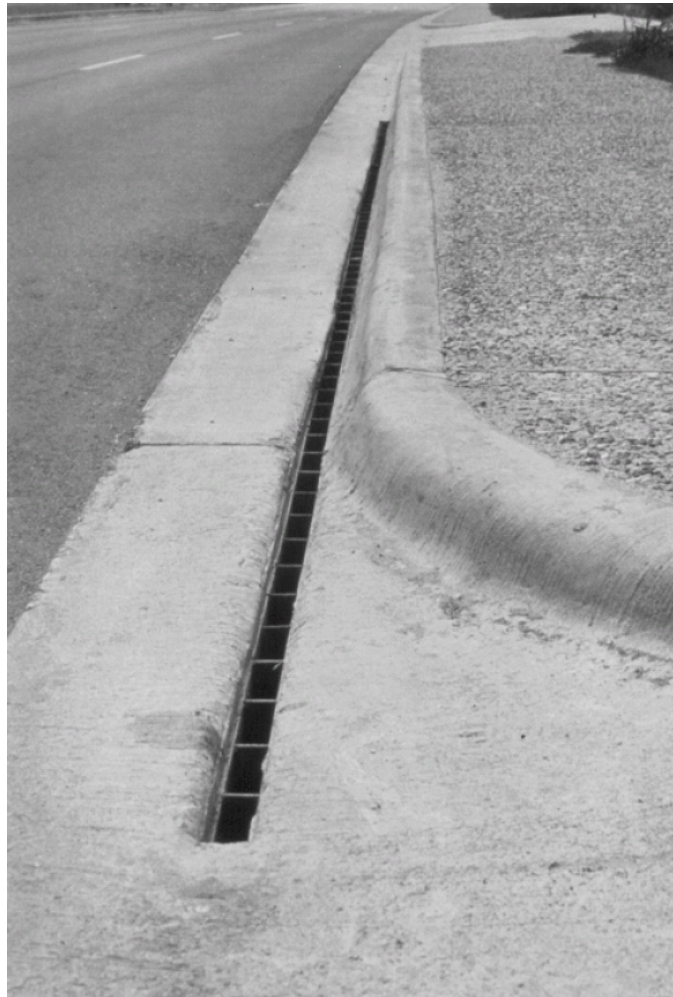

Figure 7.26 Slotted drain inlet

Inlet Location

On-grade storm drain inlets are located on slopes, while on-sag storm drain inlets are located at a low point (or depression), as shown in the following figure. When stormwater runoff reaches an on-grade storm drain inlet, at

smaller flowrates all flows are able to be captured. However, as approach flowrates increase, a point is reached where some bypass flow occurs. This bypass flow continues on past the storm drain inlet, perhaps to another storm drain inlet downstream, with additional flows joining it along the way.

The following storm drain inlet locations are available:

- On grade
- On sag

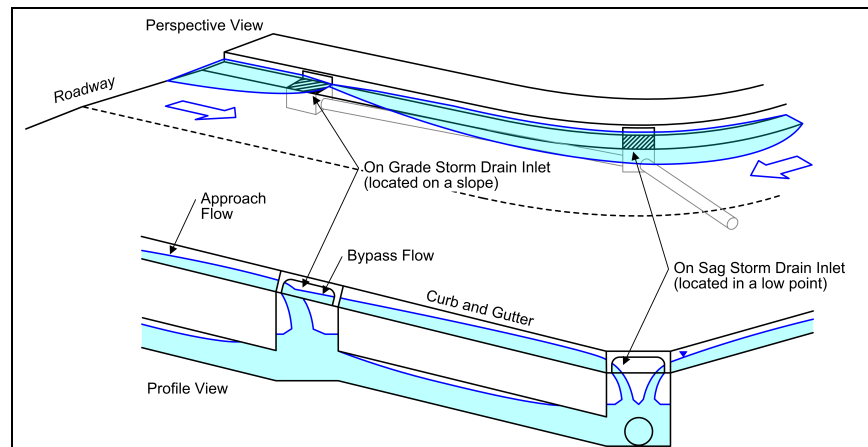

Figure 7.27 Locations of on-grade and on-sag storm drain inlets

Combination Inlet Type

If the **FHWA HEC-22 GENERIC** storm drain inlet manufacturer is selected and a **COMBINATION INLET** type is selected, then this drop-down list provides a listing of the available combination inlet types. Otherwise, this field is grayed out. The following **FHWA HEC-22 GENERIC** combination inlet types are available:

- Curb Opening & Grate
- Slotted Drain & Grate



Figure 7.28 Combination curb opening & grate inlet (with 45 degree tilt-bar grate)

Curb Opening & Grate Type

If the **FHWA HEC-22 GENERIC** storm drain inlet manufacturer is selected and a **COMBINATION INLET** type is selected and a **CURB OPENING & GRATE** combination inlet type is selected, then this drop-down list provides a listing of the available curb opening & grate types. Otherwise, this field is grayed out. The following **FHWA HEC-22 GENERIC** curb opening & grate types are available:

- Equal Length Inlet
- Sweeper Inlet

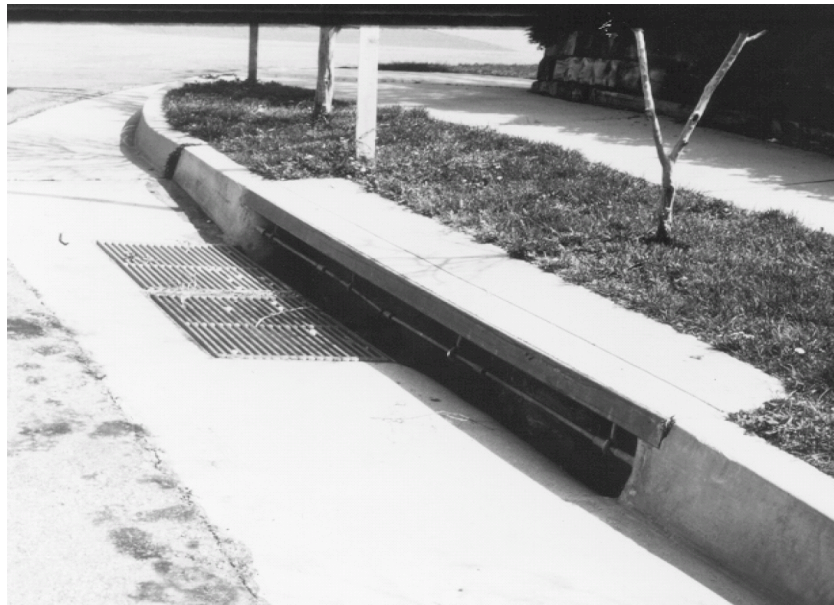

Figure 7.29 Combination sweeper curb opening & grate inlet

Catchbasin Invert Elevation

This entry defines the bottom elevation of the storm drain inlet catchbasin (ft or m). See Figure 7.25 on page 233 for an illustration of this value.

Inlet Rim Elevation

Elevation of the storm drain inlet catchbasin rim in ft or m. See Figure 7.25 on page 233 for an illustration of this value.

Ponded Area

If the inlet location is defined as located **ON SAG**, then this entry defines the surface area (ft² or m²) occupied by ponded water atop the storm drain inlet once the inlet capacity has been exceeded by the amount of inflow attempting to enter the inlet. If the inlet location is defined as located **ON GRADE**, then this entry is grayed out.

Initial Water Surface Elevation

Elevation of the water in the storm drain inlet catchbasin at the start of the simulation in ft or m. See Figure 7.25 on page 233 for an illustration of this value.

External Inflows

Click the (...) browse button to display the External Inflows for Node dialog box, which is described in detail on page 408. The External Inflows for Node dialog box defines the additional inflows entering the storm drain inlet catchbasin, such as sanitary inflows. The following inflow types are available:

- Rainfall dependent infiltrations/inflows (RDII)
- User-defined (direct) inflows
- Dry weather (sanitary) inflows

Grate Clogging Factor (optional)

This entry reduces the storm drain inlet efficiency by the specified percentage to account for debris blockage. For example, a value of 20% reduces the inlet's flow interception efficiency by 20%.

Roadway/Gutter Bypass Link

This entry defines the ID of the roadway or gutter link that receives any flow that bypasses the storm drain inlet. If the inlet location is defined as located **ON SAG**, then this entry is grayed out since there is no bypass link for sag inlets.

The drop-down list provides a listing of links (e.g., channels, pipes, pumps, orifices, weirs, or outlets), allowing you to select the bypass link. See Figure 7.25 on page 233 for an illustration of this value.

Roadway Longitudinal Slope

This entry specifies the slope (ft/ft or m/m) of the roadway with respect to the direction of stormwater flow. This entry is not available and is grayed out for storm drain inlets located **ON SAG**. See Figure 7.25 on page 233 for an illustration of this value.

Roadway Cross Slope

This entry specifies the slope (ft/ft or m/m) of the roadway perpendicular to the direction of stormwater flow. This is also known as the transverse slope. See Figure 7.30 for an illustration of this value.

Roadway Manning's

This entry specifies an average Manning's roughness coefficient for the roadway. This entry is not used for storm drain inlets on sag.

Clicking the (...) browse button will display a reference dialog box showing Manning's roughness coefficients, allowing you to determine the appropriate roughness coefficient to be used for the roadway.

Gutter Cross Slope

This entry specifies the slope (ft/ft or m/m) of the stormwater gutter perpendicular to the direction of stormwater flow. See Figure 7.30 for an illustration of this value.

Gutter Width

This entry specifies the width (ft or m) of the stormwater gutter perpendicular to the direction of stormwater flow. See Figure 7.30 for an illustration of this value.

Gutter Depression (optional)

This entry specifies an optional local gutter depression at the storm drain inlet. Storm drain inlet interception capacity and efficiency is increased by the use of a local gutter depression at the inlet opening. See Figure 7.30 for an illustration of this value.

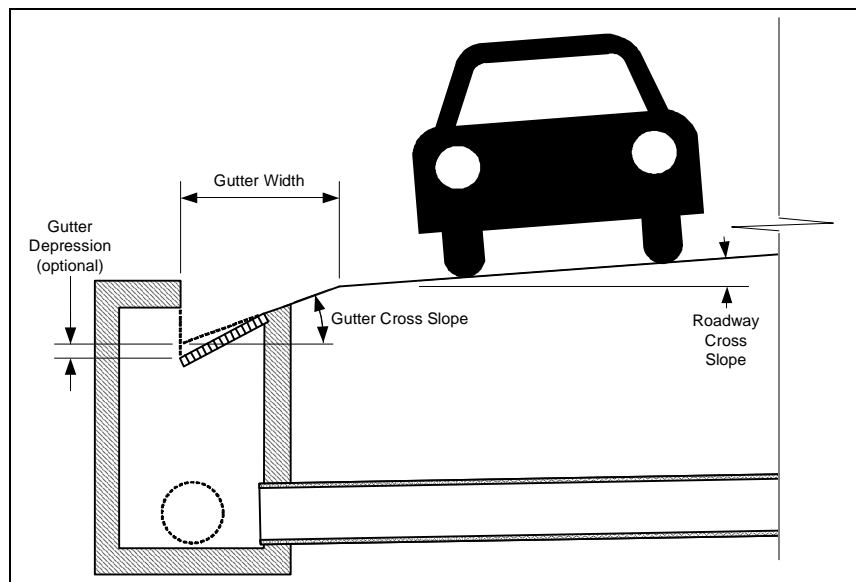

Figure 7.30 Depressed curb opening inlet dimensions

Upstream Roadway Links

This entry defines the ID's of the open channel links (e.g., roadways, storm drain gutters, channels, median ditches, etc.) that connect to the storm drain inlet. If there are more than one upstream link contributing flow to the storm drain inlet, then the drop-down list will show more than one link. Check those link(s) in the drop-down list that contribute surface water runoff to the storm drain inlet, as shown in the following figure.



Note that only those links that route surface water runoff to the storm drain inlet opening should be selected. Bypass links that connect to the storm drain inlet opening and stormwater pipes that connect to the inlet catchbasin should not be selected.

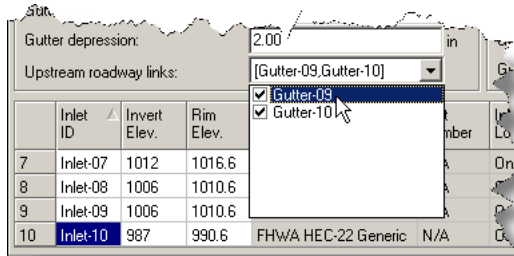

Figure 7.31 Selecting multiple upstream gutter links that contribute flow to the storm drain inlet

Additional Input Data

Depending upon the inlet manufacturer, type, and/or part number, additional input data will be presented to be completed. Most of this input data are self-explanatory and can be easily entered. However, the software attempts to provide you with any data that it has within its storm drain inlet manufacturer database. You can then over-ride any of this retrieved data with your own specific values.

Analysis Summary Results

The Inlets dialog box provides a section titled **ANALYSIS SUMMARY** that provides a brief summary of the simulation results for the selected inlet, as shown in the following figure.

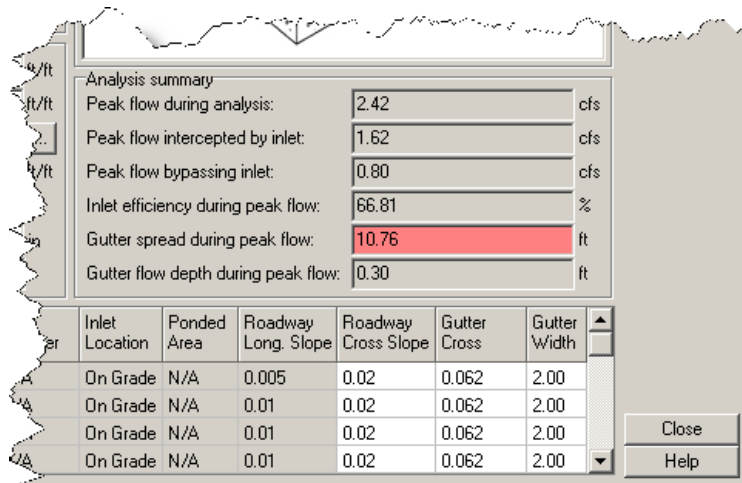

Figure 7.32 The software will highlight in red those stormwater drain inlets that are not sufficient to capture the stormwater runoff

A description of the available analysis result fields is provided below:

Peak Flow during Analysis

This analysis output field provides the maximum flow rate of water approaching the inlet (but not necessarily entering the inlet) during the simulation period.

Peak Flow Intercepted by Inlet

This analysis output field provides the maximum flow rate of water intercepted (or captured) by the inlet during the simulation period.

Peak Flow Bypassing Inlet

This analysis output field provides the maximum flow rate of water bypassing the inlet during the simulation period. This value represents the difference between the **PEAK FLOW DURING ANALYSIS** and the **PEAK FLOW INTERCEPTED BY INLET** values.

Inlet Efficiency during Peak Flow

This analysis output field shows the percentage ratio of **PEAK FLOW INTERCEPTED BY INLET** and the **PEAK FLOW DURING ANALYSIS** values. A value of 100% means that the inlet is able to capture all of the peak flow approaching the inlet. A value less than 100% means that flow is bypassing the inlet during the peak flow portion of the simulation.

Gutter Spread during Peak Flow

This analysis output field provides the maximum amount of roadway and gutter spread (or roadway width) that is covered with water during the simulation.

If this computed value is greater than the value specified in **INLET GUTTER SPREAD WARNING** entry defined in the Element Prototypes tab of the Project Options dialog (see page 185), then this field is colored as **RED**.

Gutter Flow Depth during Peak Flow

This analysis output field provides the maximum depth of water at the inlet, including any gutter depression.

Inlet Hydraulic Performance Curves

In order to review the hydraulic performance of a specified storm drain in more detail, click the More> button. As shown in the following figure, the Inlets dialog box will expand horizontally, showing a graphical representation of the inlet's hydraulic efficiency, gutter flow depth, and spread for different flow rates. This graphical plot can be printed or exported, if desired. Right-click the graph and a context menu will be displayed, allowing you to print or export the graphic, as well as adjust the graphical plot.

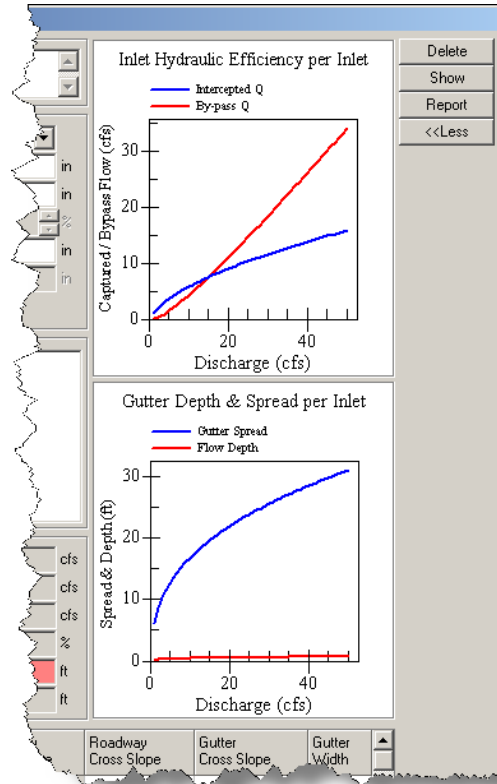

Figure 7.33 The software will display a graphical representation of the inlet's hydraulic efficiency, gutter flow depth, and spread for different flow rates

Clicking the Report button will cause the software to display the analysis results in Microsoft Excel. This report will detail all of the input data used to define the inlet data, as well as include the analysis output results. Similarly, this report is included in the analysis output report.

Design Storm Frequency

The storm drain conduit is one of the most expensive and permanent elements within a storm drainage system. Storm drains normally remain in use longer than any other system element. Once installed, it is very expensive to increase the capacity or repair the storm drain conduit. Consequently, the design storm frequency for projected hydrologic conditions should be selected to meet the need of the proposed facility for both now and well into the future.

Most state highway agencies consider a 10-year frequency storm as a minimum for the design of storm drains on interstate and major highways in urban areas. However, caution should be exercised in selecting an appropriate storm frequency. Consideration should be given to traffic volume, type and use of roadway, speed limit, flood damage potential, and the needs of the local community.

Storm drain inlets which drain sag points where runoff can only be removed through the storm drainage system should be designed for a minimum 50-year frequency storm. The storm drain inlet at a sag point as well as the storm drain pipe leading from the sag point must be sized to accommodate this additional runoff. This can be done by computing the bypass flow occurring at each upstream storm drain inlet during a 50-year rainfall and accumulating it at the sag point. Another method would be to design the upstream storm drain system for a 50-year design

to minimize the bypass to the sag point. Each case must be evaluated on its own merits and the impacts and risk of flooding at a sag point assessed.

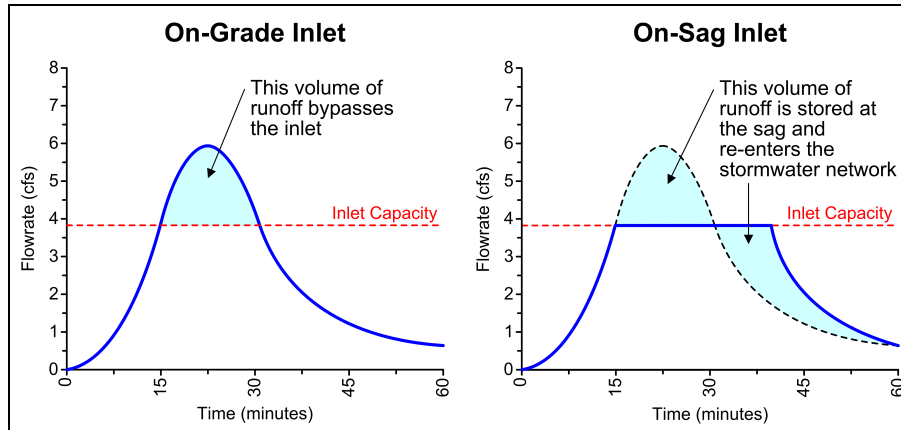

Figure 7.34 Comparison of on-grade versus on-sag storm drain inlet capacities

Following the initial design of the storm drainage system, it is prudent to evaluate the system using a higher check storm. A 100-year frequency storm is recommended for the check storm. The check storm is used to evaluate the performance of the storm drainage system and determine if the major drainage system is adequate to handle the flooding from a storm of this magnitude.

Time of Concentration for Inlet Spacing and Pipe Sizing

Generally, there are two different times of concentration to be concerned with: one for storm drain inlet spacing and the other for pipe sizing. The time of concentration for inlet spacing is the time required for water to flow from the hydraulically most distant point of the drainage area contributing only to that inlet. Typically, this is the sum of the travel times required for water to travel overland to the pavement gutter and along the length of the gutter between inlets. If the total time of concentration to the upstream inlet is less than five minutes, a minimum time of concentration of five minutes is typically used. The time of concentration for each successive inlet should be determined independently in this same manner.

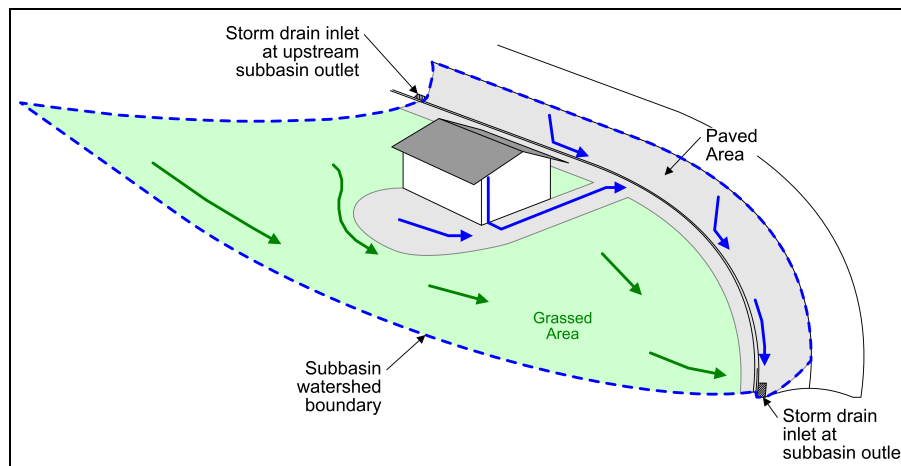

Figure 7.35 Contributing drainage area for a proposed storm drain inlet location

Preliminary pipe size should be calculated based on a full flow assumption given the discharge and pipe slope. This approach does not account for minor losses, which will be accounted for in the HGL calculation. Minor losses can be approximated at this stage of design by using a slightly higher roughness value in the full flow calculation. The pipe slope is typically established in preliminary design based on the roadway grade and the need to avoid other existing utilities or storm drains. When pipe sizes are increased in a downstream direction, it is generally preferable to match the crown elevation, rather than the invert elevation. The crown of the downstream pipe should drop by the headloss across the structure. Generally, storm drains should be designed to provide a velocity of at least 3 ft/s (1 m/s) when the conduit is full to insure that the pipe is self cleaning.

The time of concentration for pipe sizing is defined as the time required for water to travel from the most hydraulically distant point in the total contributing watershed to the design point. Typically, this time consists of two components: (1) the time for overland and gutter flow to reach the first inlet, and (2) the time to flow through the storm drainage system to the point of interest.

Storm Drain Inlet Sizing, Spacing, and Locating

Most local, regional, and state highway and transportation agencies maintain design standards for storm drain inlet sizing, spacing, and locating. Inadequate inlet capacity or poor inlet location may cause flooding on the roadway resulting in a hazard to the traveling public.

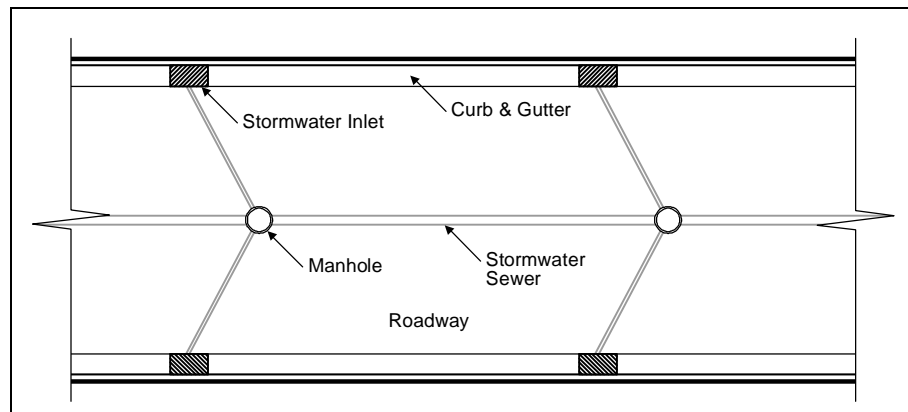

Figure 7.36 Example inlet locations (Source: US DOT Federal Highway Administration, August 2001, *Hydraulic Design Series No. 4, Introduction to Highway Design*)

Storm drains are normally located on public property. On occasion, it may be necessary to locate storm drains on private property in easements. The acquisition of required easements can be costly, and should be avoided wherever possible.

Inlet structures are located at the upstream end and at intermediate points along a storm drain line. Inlet spacing is controlled by the geometry of the site, inlet opening capacity, and tributary drainage magnitude. Inlet placement is generally a trial and error procedure that attempts to produce the most economical and hydraulically effective system.

The optimal spacing of storm drain inlets depends on several factors, including:

- Traffic requirements
- Contributing land use
- Street slope
- Inlet opening capacity
- Distance to the nearest outfall

The capture (or interception) rate of inlets for a continuous grade condition varies from less than 50% to more than 100% of the allowable street capacity. Therefore, optimal inlet spacing cannot be achieved in all instances.

Generally, inlet spacing should be based upon a stormwater capture rate of 70% to 80%. This is typically more economical than trying to achieve a spacing based upon a 100% capture rate. Only the most downstream inlet in a development should be designed to capture 100% of the remaining stormwater flow. Inlet spacing design should consider improvements in the overall stormwater network efficiency if inlets are located at the sumps created at street intersections.

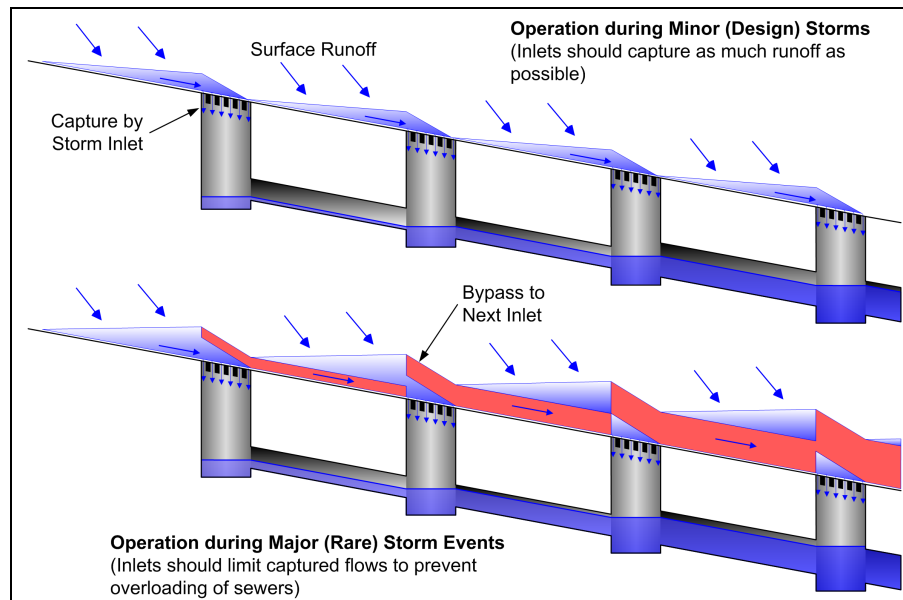

Figure 7.37 Illustration showing the optimum design of stormwater drainage inlet locations to account for sewer and street drainage

The first step in storm drain design is to develop a preliminary storm drain layout, including inlet, access hole and pipe locations. This is usually completed on a plan view map that shows the roadway, bridges, adjacent land use conditions, intersections, and under/overpasses. Other utility locations and situations should also be identified and shown, including surface utilities, underground utilities and any other storm drain systems. Storm drain alignment within the road right-of-way is usually influenced, if not dictated, by the location of other utilities. These other utilities, which may be public or private, may cause interference with the alignment or elevation of the proposed storm drain.

Generally, a storm drain should be kept as close to the surface as minimum cover and/or hydraulic requirements allow to minimize excavation costs. Another location control is the demand of traffic and the need to provide for traffic flow during construction including the possibility of detours. Providing curved storm drain alignments may be cost effective and should be considered for large pipe

sizes, especially when headlosses are a concern. The deflection angle is divided by the allowable deflection per joint to determine the number of pipe sections required to create a given curve.

Tentative storm drain inlets, junction boxes, and manhole access locations should be identified based primarily on experience factors. The initially estimated type and location of inlets will provide the basis for hydrologic calculations and pipe sizing, and will be adjusted as required during the design process. Ultimately, inlets must be provided based on spread criteria and/or intersection requirements. Generally, all flow approaching an intersection should be intercepted, as cross gutters are not practical in highway applications.

Access is required for inspection and maintenance of storm drain systems. For storm drains smaller than about 48 inches (1.2 m), access is required about every 400 ft (120 m), while for larger sizes the spacing can be 600 ft (180 m) and larger. Junction boxes are also required at the confluence of two or more storm drains, where pipe size changes, at sharp curves or angle points (greater than 10°), and at abrupt grade changes.

The following general rules apply to storm drain inlet placement:

- An inlet is required at the uppermost point in a gutter section where gutter capacity criteria are violated. This point is established by moving the inlet and thus changing the drainage area until the tributary flow equals the gutter capacity. Successive inlets are spaced by locating the point where the sum of the bypassing flow and the flow from the additional contributing area exceed the gutter capacity.
- The sizing and spacing of inlets should be upon a stormwater capture (or interception) rate of 70% to 80%, except the most downstream inlet of a development which should capture 100% of the remaining stormwater flow.
- Inlets are normally used at intersections to prevent street cross flow which could cause pedestrian or vehicular hazards. It is desirable to intercept 100 percent of any potential street cross flow under these conditions. Intersection inlets should be placed on tangent curb sections near corners.
- Inlets are also required where the street cross slope begins to superelevate. The purpose of these inlets is also to reduce the traffic hazard from street cross flow. Sheet flow across the pavement at these locations is particularly susceptible to icing.
- Inlets should also be located at any point where side drainage enters streets and may overload gutter capacity. Where possible, these side drainage inlets should be located to intercept side drainage before it enters the street.
- Inlets should be placed at all sag points in the gutter grade and at median breaks.
- Inlets are also used upstream of bridges to prevent pavement drainage from flowing onto the bridge decks, and downstream of bridges to intercept drainage from the bridge.
- As a matter of general practice, inlets should not be located within driveway areas.

On Sag Storm Drain Inlets

Many times on sag storm drain inlets are located in the center of a drainage area, such as in the middle of a parking lot. As such, some of the input parameters that are specified have no bearing on the actual storm drain inlet. In this situation,

simply enter for placeholder values, similar to what is shown in the following figure. These values will have minimal impact on the hydraulic analysis.

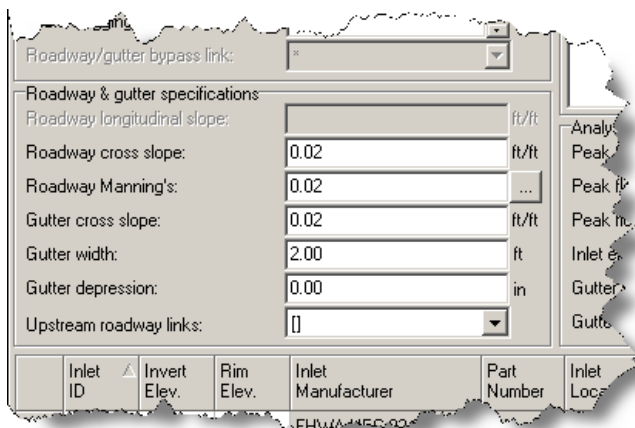

Figure 7.38 For on sag storm drain inlets located in the center of a large drainage area, enter placeholder values for the required additional input data

Similarly, when specifying the **INLET TYPE** (i.e., Grated Inlet, etc.), it is easy to be confused that a curb is part of the input specification. However, for an on sag storm drain inlet, the curb portion of the inlet specification is not required.

Unit Conversion Problems



Note that changing the flow units of an existing network model (even within the same unit system, i.e., metric) can create conversion problems. This is due to the change in the units used to define the maximum capture cutoff value or a gutter flow capture curve. For example, changing the flow units from CMS to LPS in the Project Options dialog box (see page 163), will cause the maximum capture cutoff value input data requirements change from CMS to LPS. However, previously entered input data in CMS units will not automatically convert to LPS units. Therefore, the hydraulic response of any previously defined storm drain inlet structures will change due to the flow unit change, and will make this change difficult to pinpoint in troubleshooting the model.

Flow Diversions



Flow diversion structures (sometimes called *flow splitters*, *flow regulators*, *dividers*, or *by-passes*) are used generally used in modeling combined sewer systems (i.e., convey of stormwater and sanitary sewer), where these structures are used to control the flow between sanitary sewer collection system and the interceptor pipe to the wastewater treatment plant (WWTP). These structures allow the conveyance of wastewater to the WWTP during dry weather conditions. During periods of moderate to heavy rainfall, the capacity of the combined sewer system can be exceeded. During these extreme wet weather conditions, these structures divert excessive flows away from the interceptor pipe and discharge directly into a water course to avoid surcharge and flooding of the combined sewer system. This results in what are known as combined sewer overflows (CSOs). CSO discharges can cause

serious pollution problems in receiving waters. Specifically, pollutants that are typically present in CSOs include the following:

- Bacteria from human and animal fecal matter, which could cause illness
- Oxygen demanding pollutants that may deplete the concentration of dissolved oxygen in the receiving water to levels that may be harmful to aquatic life
- Suspended solids that may increase turbidity or damage streambed organism communities
- Nutrients that may cause eutrophication
- Toxics that may persist, bioaccumulate, or stress the aquatic environment
- Floatable litter that may either harm aquatic wildlife or become a health and aesthetic nuisance to swimmers and boaters

Flow diversion structures can be used to model side weirs, leaping weirs, transverse weirs, orifices, and relief siphons. A flow diversion can have no more than two pipes and/or channels on its downstream discharge side where flow can split in two directions. Flow diversions are only active when performing Kinematic Wave routing and are treated as simple junctions under Hydrodynamic Routing. There are four types of flow diversion structures, defined by the manner in which inflows are diverted:

- Cutoff
- Overflow
- Tabular
- Weir

For example, the flow diverted through a weir flow diversion is computed by the following equation:

$$Q_{div} = C_w (f H_w)^{1.5}$$

where:

$$\begin{aligned} Q_{div} &= \text{diverted flow} \\ C_w &= \text{weir coefficient} \\ H_w &= \text{weir height} \end{aligned}$$

And, f is computed as:



$$f = \frac{Q_{in} - Q_{min}}{Q_{max} - Q_{min}}$$

where:

$$\begin{aligned} Q_{in} &= \text{inflow to the flow diversion} \\ Q_{min} &= \text{flow at which diverted flow begins} \\ Q_{max} &= C_w H_w^{1.5} \end{aligned}$$

The user-specified parameters for the weir flow diversion are Q_{min} , H_w , and C_w . The principal input parameters for a flow diversion are:

- Junction parameters
- Name of the channel or pipe link receiving the diverted flow
- Method used for computing the amount of diverted flow

The Flow Diversions dialog box, as shown in the following figure, is displayed when an existing flow diversion structure is selected for editing by double-clicking it in the Plan View using the **SELECT ELEMENT**  tool. Also, you can choose **INPUT**  **FLOW DIVERSIONS** or double-click the **FLOW DIVERSIONS**  icon from the data tree to display the Flow Diversions dialog box.

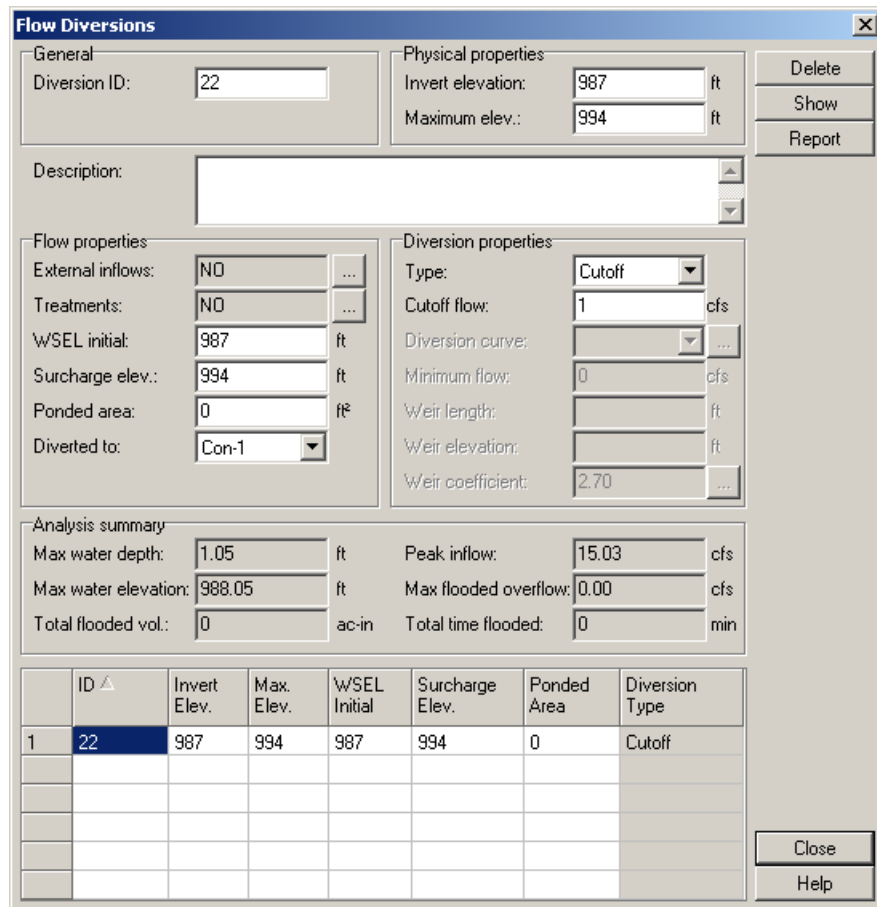

ID	Invert Elev.	Max. Elev.	WSEL Initial	Surcharge Elev.	Ponded Area	Diversion Type
22	987	994	987	994	0	Cutoff

Figure 7.39 The Flow Diversions dialog box

To select a flow diversion, scroll through the displayed table and click the row containing the flow diversion of interest. The provided data entry fields will then display information describing the selected flow diversion.

A new flow diversion is added interactively on the Plan View using the **ADD FLOW DIVERSION**  tool. To delete an existing flow diversion, select the flow diversion from the table and then click the Delete button. Click the Show button to zoom to a region around the currently selected flow diversion in the Plan View, and then highlight the flow diversion. Click the Report button to generate a Microsoft Excel report detailing all currently defined flow diversion input data and any corresponding analysis results.

The following illustration details the input data required to define a flow diversion within the software.

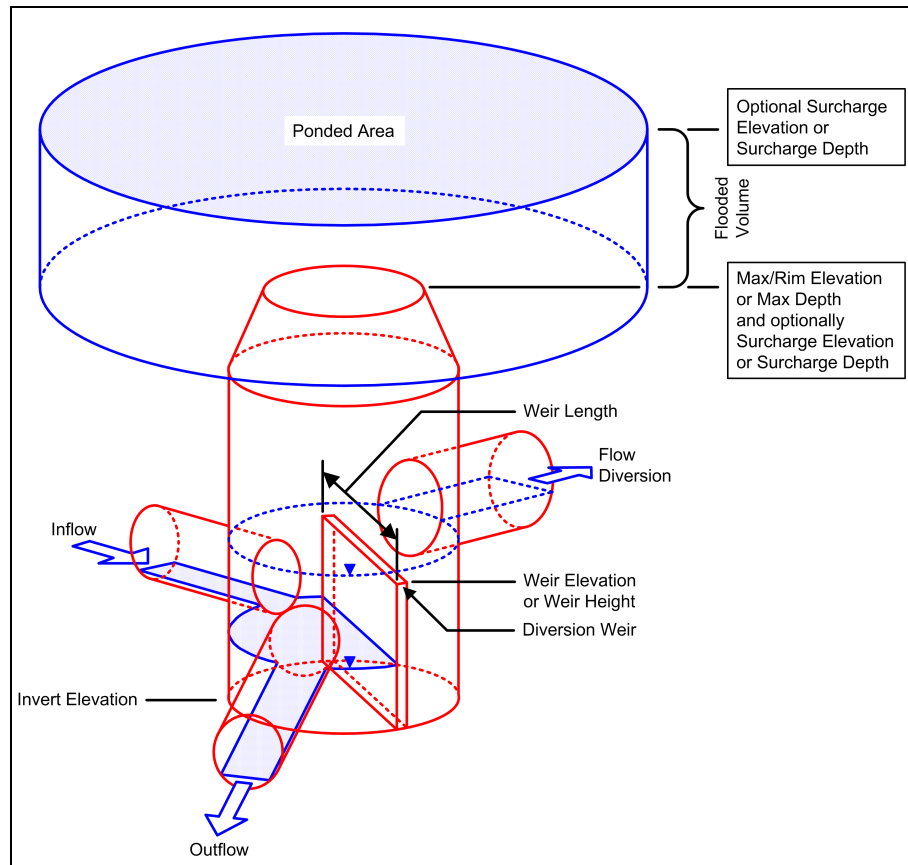

Figure 7.40 The input data used to define a flow diversion

The following data are used to define a flow diversion:

Diversion ID

Enter the unique name (or ID) that is to be assigned to the flow diversion structure being defined. This name can be alphanumeric (i.e., contain both numbers and letters), can contain spaces, is case insensitive (e.g., *ABC = abc*), and can be up to 128 characters in length. Therefore, the assigned name can be very descriptive, to assist you in identifying different flow diversion structures.

A new flow diversion ID is automatically defined by the software when a new diversion is added. However, the flow diversion ID can be changed within this field.

When importing (or merging) multiple stormwater or sanitary sewer network models into a single model, the software will check for collisions between identical flow diversion IDs and can automatically assign a new flow diversion ID for any diversions being imported that contain the same flow diversion ID as already exist in the network model. See the section titled *Merging Network Models* on page 494 for more information.

Description (optional)

Enter an optional description that describes the flow diversion structure being defined.

External Inflows

Click the (...) browse button to display the External Inflows for Node dialog box, which is described in detail on page 408. The External Inflows for Node dialog box defines the additional inflows entering the flow diversion structure, such as sanitary inflows. The following inflow types are available:

- Rainfall dependent infiltrations/inflows (RDII)
- User-defined (direct) inflows
- Dry weather inflows

Treatments

Click the (...) browse button to display the Pollutant Treatments dialog box, which is described in detail on page 462. The Pollutant Treatments dialog box defines the treatment functions for pollutants entering the flow diversion structure.

Invert Elevation

This entry defines the bottom elevation of the flow diversion structure (ft or m). See Figure 7.40 for an illustration of this value.

Maximum Elevation (or Maximum Depth)

Elevation of the flow diversion structure manhole rim (or height of the flow diversion structure above the flow diversion structure invert) in ft or m. See Figure 7.40 for an illustration of this value.

WSEL Initial (or Initial Depth)

Elevation of the water in the flow diversion structure (or depth of water above the flow diversion structure invert) at the start of the simulation in ft or m. See Figure 7.40 for an illustration of this value.

Surcharge Elevation (or Surcharge Depth)

Elevation value (or depth above the flow diversion structure invert) where pressurized flow is considered to occur (ft or m). This value can be used to simulate bolted (sealed) manhole covers and force main connections. Note that if the flow diversion structure is to be allowed to flood when it overflows, then the node cannot become pressurized and this value should be set equal to the flow diversion structure invert or set to a very high elevation to allow flooding to occur. See Figure 7.40 for an illustration of this value.

Ponded Area

This entry defines the surface area (ft² or m²) occupied by ponded water atop the flow diversion structure once the water depth exceeds the rim elevation of the flow diversion structure. If the **ENABLE OVERFLOW PONDING AT NODES** analysis option is turned on in the Project Options dialog box (see page 177), a non-zero value for this parameter will allow ponded water to be stored and subsequently returned to the drainage system when capacity exists. See Figure 7.40 for an illustration of this value.

Diverted To

This entry defines the ID of the link that receives the diverted flow. The drop-down list provides a listing of links (e.g., channels, pipes, pumps, orifices, weirs, or outlets), allowing you to select the link that receives the diverted flow. See Figure 7.40 for an illustration of this value.

Type

This drop-down list allows you to select the flow diversion type. There are four types of flow diversion structures, defined by the manner in which inflows are diverted:

- Cutoff** Diverts all inflow above a defined cutoff value
- Overflow** Diverts all inflow above the flow capacity of the non-diverted conduit
- Tabular** Uses a table that expresses diverted flow as a function of total inflow
- Weir** Uses the weir equation to compute diverted flow

Cutoff Flow

This value denotes the cutoff flow rate (cfs or cms).

Diversion Curve

This drop-down list allows you to select an already defined diversion curve that contains the tabular data of diverted flow versus total flow (cfs or cms) for the diversion flow structure. Click the [...] browse button to display the Flow Diversions Curves dialog box, described in the next section, to define a new diversion curve.

Minimum Flow

This value denotes the minimum flow at which the diversion begins for weir flow (cfs or cms). Note that the software checks that the value of the weir discharge coefficient times the weir maximum depth raised to the 3/2 power is greater than the specified minimum flow.

Weir Length

This value denotes the length of the weir, perpendicular to the flow (ft or m). See Figure 7.40 for an illustration of this value.

Weir Elevation (or Weir Height)

Elevation of the weir crest (or height of the weir crest above the inlet node invert) in ft or m. See Figure 7.40 for an illustration of this value.

Weir Coefficient

Weir discharge coefficient. Typical coefficients are in the range of 2.65 to 3.10 for flow in cfs. Clicking the [...] browse button will display the Weir Properties reference dialog box, as shown in the following figure, which provides a listing of typical weir discharge coefficients that can be used for a weir flow diversion.

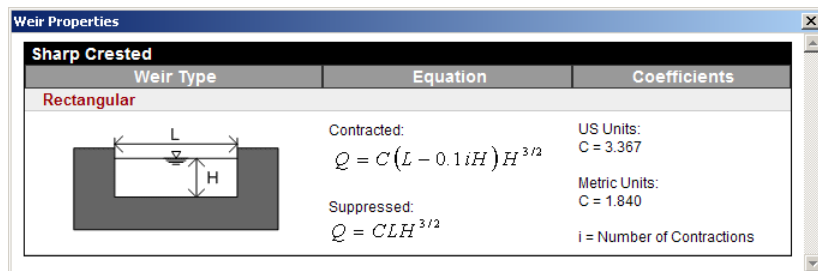

Figure 7.41 The Weir Properties reference dialog box

Analysis Summary Section

The Flow Diversions dialog box provides a section titled **ANALYSIS SUMMARY** that provides a brief summary of the simulation results for the selected diversion, as shown in the following figure.

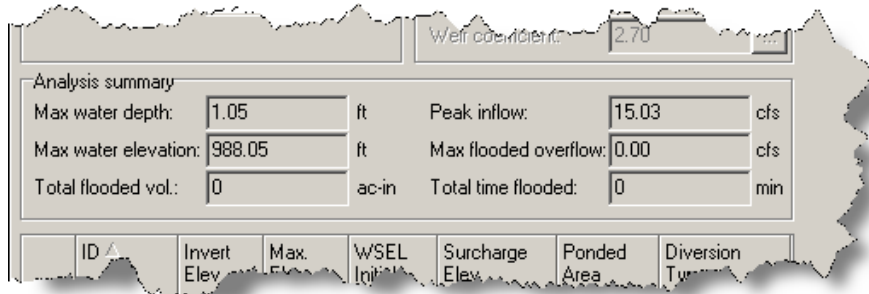

Figure 7.42 The Analysis Summary section of the Flow Diversions dialog box

A description of the available analysis result fields is provided below:

Max Water Depth

This analysis output field provides the maximum water depth that occurred at the flow diversion node during the simulation period.

Max Water Elevation

This analysis output field provides the maximum water elevation that occurred at the flow diversion node during the simulation period.

Total Flooded Volume

This analysis output field provides the total volume of water that flooded out of (or ponded above) the flow diversion node during the simulation period. This water may or may not have re-entered the flow diversion node when the flooding subsided—depending upon the analysis options selected. See the section titled *Surface Ponding* on page 218 for more information.

Peak Inflow

This analysis output field provides the maximum flow rate of water entering the flow diversion node during the simulation period.

Max Flooded Overflow

This analysis output field provides the maximum flow rate of water flooding (or ponding) from the flow diversion node during the simulation period.

Total Time Flooded

This analysis output field provides the time, in minutes, that a flow diversion node was flooded.

Flow Diversion Structure Design

While many stormwater facilities are designed to meet multiple objectives (e.g., water quality, erosion control, quantity control), some stormwater management program (SWMP) designs are intended for water quality control only. In such cases, the design capacity of the SWMP will normally be less than the capacity of the stormwater conveyance system. It is often necessary to by-pass larger flows in order to prevent problems with the SWMP (e.g., re-suspension of sediment) or damage to the facility (e.g., compaction of soil, etc.). Flow diversions are used to direct the runoff from a water quality storm into an end-of-pipe stormwater management

facility, but by-pass excess flows from larger events around the facility into another SWMP or directly into the receiving waters.

Generally, municipalities will not accept mechanical and electrical controls on stormwater management facilities due to the potential for operational and maintenance problems associated with numerous real-time control systems. Therefore, the preferred flow diversion designs operate on hydraulic principles.

The design of a hydraulically operated flow diversion must account for backwater conditions in the SWMP facility, the hydraulic potential into the facility at the design by-pass rate, and the potential for flow reversal during the recession limb of a storm. A typical flow diversion structure is shown in the following figure.

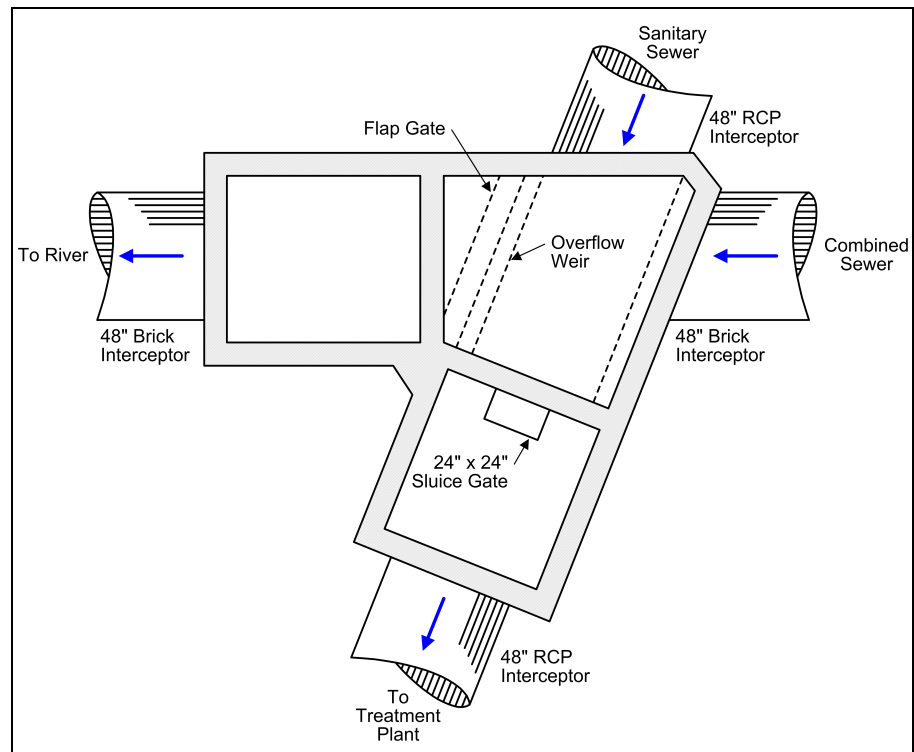

Figure 7.43 Typical CSO (combined sewer overflow) flow diversion structure

Flow Diversion Curves

The Flow Diversion Curves dialog box, as shown in the following figure, is displayed when a new flow diversion curve is created or an existing flow diversion curve is selected for editing. This curve relates diverted outflow to total inflow for a flow diversion structure. Select **INPUT** ► **FLOW DIVERSION CURVES** or double-click the **FLOW DIVERSIONS CURVES** icon from the data tree to display the Flow Diversion Curves dialog box. This dialog box can also be displayed by clicking the browse button from the **DIVERSION CURVE** data field in the Flow Diversions dialog box (see page 251) when defining the flow diversion structure.

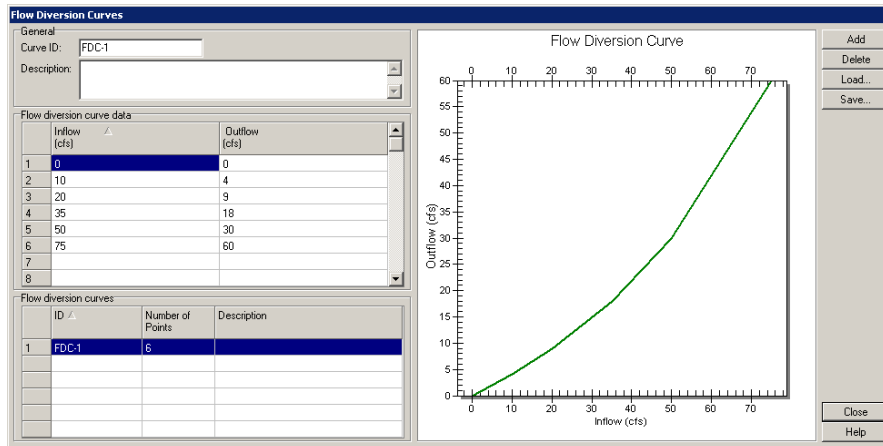

Figure 7.44 The Flow Diversion Curves dialog box

To select an existing flow diversion curve, scroll through the diversion curves table and click the row containing the flow diversion rating curve of interest. The provided data definition table will then display the inflow versus outflow data describing the selected flow diversion curve. In addition, a rating curve graphical plot of inflow versus outflow is displayed, showing the flow diversion routing properties of the selected flow diversion. This graphical plot can be printed or exported, if desired. Right-click the graph and a context menu will be displayed, allowing you to print or export the graphic, as well as adjust the graphical plot.

To add a new flow diversion curve, click the Add button and then enter the appropriate curve data in the data definition table. To delete a flow diversion curve, select the flow diversion curve from the diversion curves table and then click the Delete button.

The following data are used to define a flow diversion curve:

Diversion Curve ID

Enter the unique name (or ID) that is to be assigned to the diversion curve being defined. This name can be alphanumeric (i.e., contain both numbers and letters), can contain spaces, is case insensitive (e.g., ABC = abc), and can be up to 128 characters in length. Therefore, the assigned name can be very descriptive, to assist you in identifying different diversion curves.

Description (optional)

Enter an optional comment or description of the flow diversion curve.

Inflow / Outflow

Enter the total inflow (cfs or cms) versus diverted outflow (cfs or cms) curve data. Right-click the data table to display a context menu. This menu contains commands to cut, copy, insert, and paste selected cells in the table as well as options to insert or delete rows.

Right-Click Context Menu

Right-click the data table to display a context menu. This menu contains commands to cut, copy, insert, and paste selected cells in the table as well as options to insert or delete rows. The table values can be highlighted and copied to the clipboard for pasting into Microsoft Excel. Similarly, Excel data can be pasted into the table of inflow versus outflow.

Importing and Exporting Flow Diversion Curve Data

Click the Load button to import a flow diversion curve that was previously saved to an external file or click the Save button to export the current flow diversion curve data to an external file.

Unit Conversion Problems



Note that changing the flow units of an existing network model (even within the same unit system, i.e., metric) can create conversion problems. This is due to the change in the units used to define flow diversion curves. For example, changing the flow units from CMS to LPS in the Project Options dialog box (see page 163), will cause the flow diversion curve input data requirements change from CMS to LPS. However, previously entered input data in CMS units will not automatically convert to LPS units. Therefore, the hydraulic response of any previously defined flow diversion structures will change due to the flow unit change, and will make this change difficult to pinpoint in troubleshooting the model.

Outfalls



Outfalls are terminal nodes of the drainage system used to define the final downstream boundaries when using Hydrodynamic Routing. For other types of routing, outfalls behave the same as a junction. Only a single channel or pipe link can be connected to an outfall. However, subbasins can also be directly connected to an outfall. When using Hydrodynamic Routing, there must be at least one node designated as an outfall.

The boundary conditions at an outfall can be described by any one of the following stage relationships:

- Critical or normal flow depth in the connecting channel or pipe link
- Fixed stage elevation
- Tidal stage described in a table of tide height versus hour of the day
- User-defined time series of stage versus time

The principal input parameters for an outfall include:

- Invert elevation
- Boundary condition type and stage description
- Presence of a flap gate to prevent backflow through the outfall structure

The Outfalls dialog box, as shown in the following figure, is displayed when an existing outfall is selected for editing by double-clicking it in the Plan View using the **SELECT ELEMENT**  tool. Also, you can choose **INPUT ► OUTFALLS** or double-click the **OUTFALLS**  icon from the data tree to display the Outfalls dialog box.

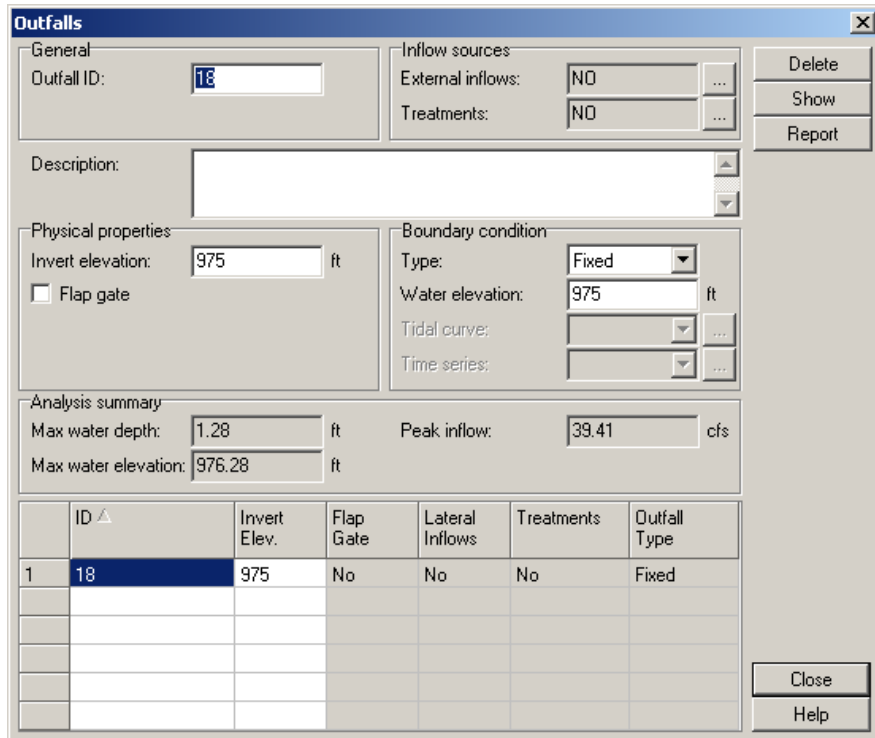



Figure 7.45 The Outfalls dialog box

To select an outfall, scroll through the displayed table and click the row containing the outfall of interest. The provided data entry fields will then display information describing the selected outfall.

A new outfall is added interactively on the Plan View using the **ADD OUTFALL**  tool. To delete an existing outfall, select the outfall from the table and then click the Delete button. Click the Show button to zoom to a region around the currently selected outfall in the Plan View, and then highlight the outfall. Click the Report button to generate a Microsoft Excel report detailing all currently defined outfall input data and any corresponding analysis results.

The following data are used to define an outfall structure:

Outfall ID

Enter the unique name (or ID) that is to be assigned to the outfall being defined. This name can be alphanumeric (i.e., contain both numbers and letters), can contain spaces, is case insensitive (e.g., *ABC = abc*), and can be up to 128 characters in length. Therefore, the assigned name can be very descriptive, to assist you in identifying different outfall structures.

A new outfall ID is automatically defined by the software when a new outfall is added. However, the outfall ID can be changed within this field.

When importing (or merging) multiple stormwater or sanitary sewer network models into a single model, the software will check for collisions between identical outfall IDs and can automatically assign a new outfall ID for any outfalls being imported that contain the same outfall ID as already exist in the network model. See the section titled *Merging Network Models* on page 494 for more information.

Description (optional)

Enter an optional description that describes the outfall structure being defined.

External Inflows

Click the browse button to display the External Inflows for Node dialog box, which is described in detail on page 408. The External Inflows for Node dialog box defines the additional inflows entering the outfall structure, such as sanitary inflows. The following inflow types are available:

- Rainfall dependent infiltrations/inflows (RDII)
- User-defined (direct) inflows
- Dry weather inflows

Treatments

Click the browse button to display the Pollutant Treatments dialog box, which is described in detail on page 462. The Pollutant Treatments dialog box defines the treatment functions for pollutants entering the outfall structure.

Invert Elevation

This entry defines the bottom elevation of the outfall structure (ft or m).

Flap Gate

This check box is used to denote whether a flap gate exists to prevent backflow through the outfall structure. By default, no flap gate is defined.

Type

This drop-down list allows you to select the outfall structure type. The following outfall structures are available:

Free	Outfall elevation set to the minimum elevation between critical flow depth and normal flow depth in the connecting conduit
Normal	Outfall elevation set to normal flow depth in the connecting conduit
Fixed	Outfall elevation defined as a fixed elevation
Tidal	Tidal stage described in a table of tide elevation versus hour of the day
Time Series	A user-defined time series of stage elevation versus time

Water Elevation (or Water Depth)

This value denotes the water surface elevation (or height of the water above the outfall invert) when a **FIXED** outfall structure has been selected, in ft or m.

Tidal Curve

This drop-down list allows you to select an already defined tidal curve that contains the tabular data of time of day versus tide elevation (ft or m) for the outfall structure. Click the browse button to display the Outfall Tidal Curves dialog box, which is described in detail in the next section, to define a new tidal curve.

Time Series

This drop-down list allows you to select an already defined time series that contains the tabular data of time of day versus water surface elevation (ft or m) for the outfall structure. Click the (...) browse button to display the Time Series dialog box, which is described in detail on page 467, to define a new time series.

Analysis Summary Section

The Outfalls dialog box provides a section titled **ANALYSIS SUMMARY** that provides a brief summary of the simulation results for the selected outfall, as shown in the following figure.

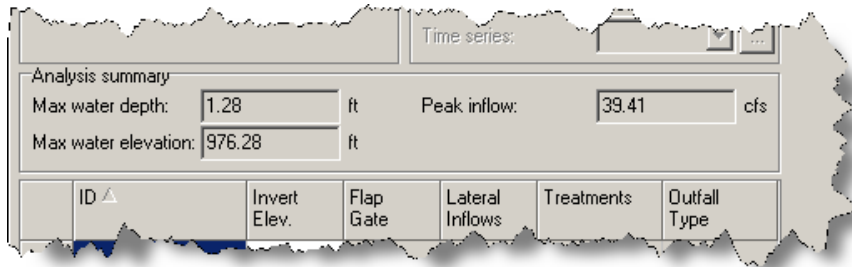

Figure 7.46 The Analysis Summary section of the Outfalls dialog box

A description of the available analysis result fields is provided below:

Max Water Depth

This analysis output field provides the maximum water depth that occurred at the outfall node during the simulation period.

Max Water Elevation

This analysis output field provides the maximum water elevation that occurred at the outfall node during the simulation period.

Peak Inflow

This analysis output field provides the maximum flow rate of water entering the outfall node during the simulation period.

Outfall Tidal Curves

The Outfall Tidal Curves dialog box, as shown in the following figure, is displayed when a new tidal curve is created or an existing tidal curve is selected for editing. This curve describes how the stage at an outfall changes by hour of the day. Select **INPUT > OUTFALL TIDAL CURVES** or double-click the **OUTFALL TIDAL CURVES** icon from the data tree to display the Outfall Tidal Curves dialog box. This dialog box can also be displayed by clicking the (...) browse button from the **TIDAL CURVE** data field in the Outfalls dialog box (see page 257) when defining an outfall tidal curve.

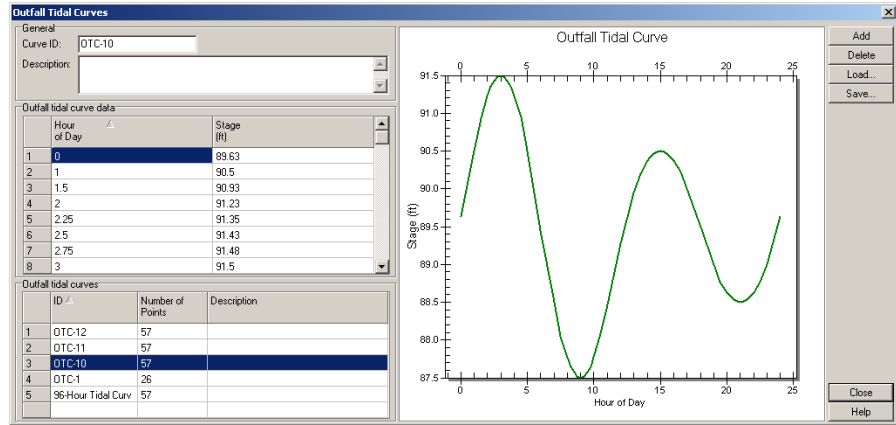

Figure 7.47 The Outfall Tidal Curves dialog box

To select an existing outfall tidal curve, scroll through the tidal curves table and click the row containing the outfall tidal curve of interest. The provided data definition table will then display the time versus stage data describing the selected outfall tidal curve. In addition, a graphical plot of time versus stage is displayed, showing the tidal stage of the selected outfall. This graphical plot can be printed or exported, if desired. Right-click the graph and a context menu will be displayed, allowing you to print or export the graphic, as well as adjust the graphical plot.

To add a new outfall tidal curve, click the Add button and then enter the curve data in the data definition table. To delete an outfall tidal curve, select the outfall tidal curve from the tidal curves table and then click the Delete button.

The following data are used to define an outfall tidal curve:

Tidal Curve ID

Enter the unique name (or ID) that is to be assigned to the tidal curve being defined. This name can be alphanumeric (i.e., contain both numbers and letters), can contain spaces, is case insensitive (e.g., ABC = abc), and can be up to 128 characters in length. Therefore, the assigned name can be very descriptive, to assist you in identifying different tidal curves.

Description (optional)

Enter an optional comment or description of the tidal curve.

Hour of Day / Stage

Enter the tidal curve's time (hour) versus stage (ft or m) curve data. Right-click the data table to display a context menu. This menu contains commands to cut, copy, insert, and paste selected cells in the table as well as options to insert or delete rows.

Right-Click Context Menu

Right-click the data table to display a context menu. This menu contains commands to cut, copy, insert, and paste selected cells in the table as well as options to insert or delete rows. The table values can be highlighted and copied to the clipboard for pasting into Microsoft Excel. Similarly, Excel data can be pasted into the table of time versus stage.

Importing and Exporting Tidal Curve Data

Click the Load button to import a tidal curve that was previously saved to an external file or click the Save button to export the current tidal curve data to an external file.

Pumps

Pumps are used to lift water to higher elevations as shown in the schematic illustration in the following figure. They are internally represented as a link connecting two nodes.

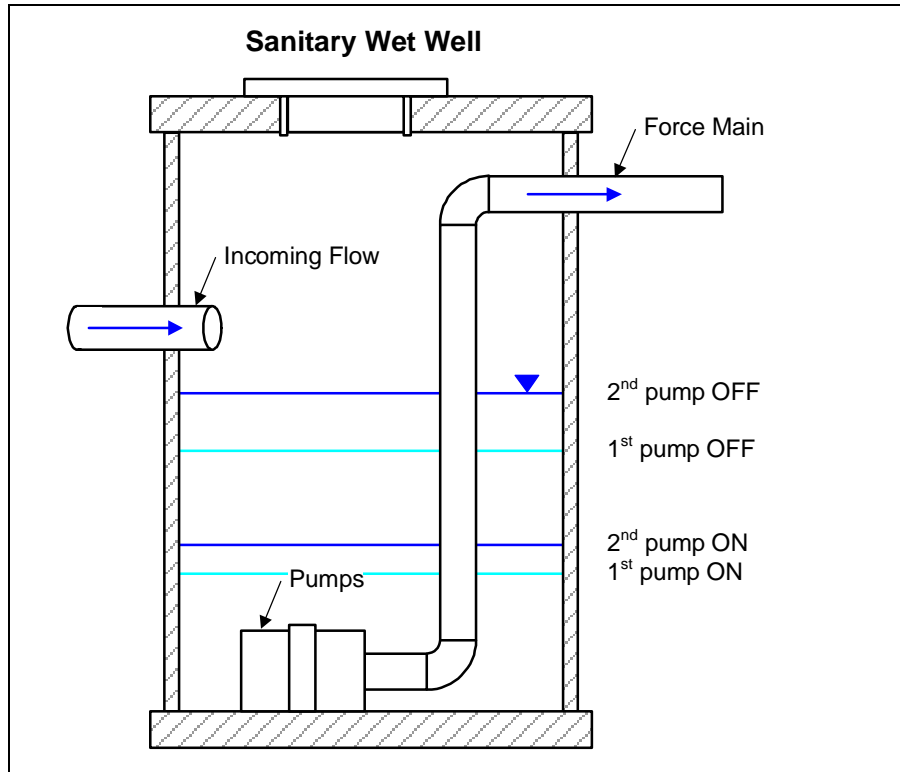



Figure 7.48 Sample pump station for sanitary force main (schematic)

The Pumps dialog box, as shown in the following figure, is displayed when an existing pump is selected for editing by double-clicking it in the Plan View using the **SELECT ELEMENT**  tool. Also, you can choose **INPUT > PUMPS** or double-click the **PUMPS**  icon from the data tree to display the Pumps dialog box.

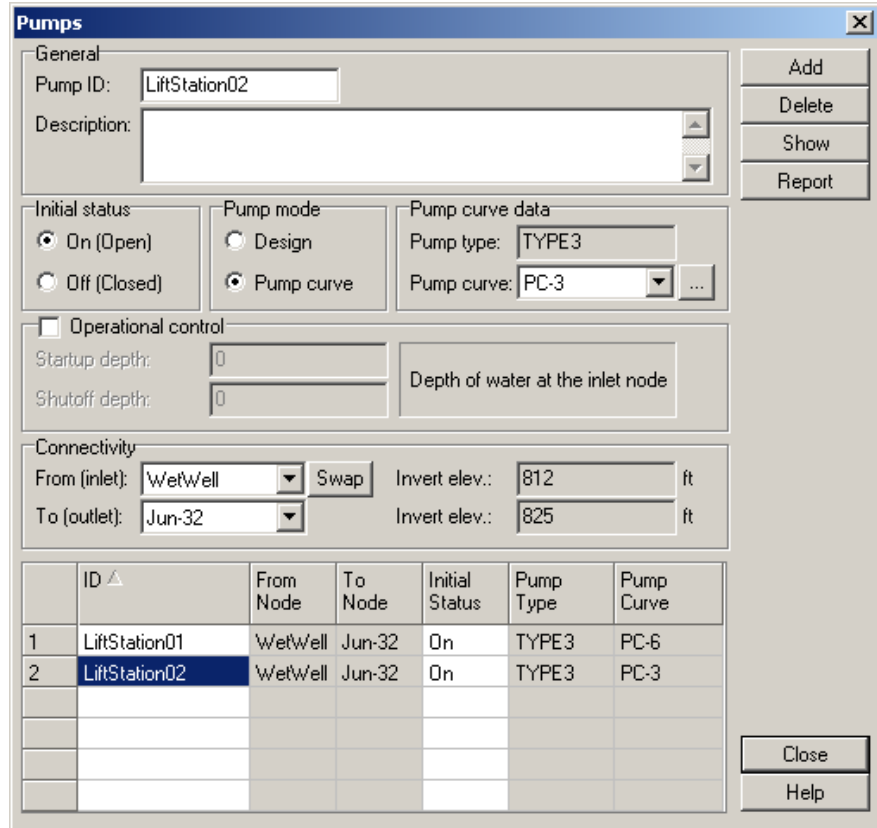

Figure 7.49 The Pumps dialog box

To select a pump, scroll through the displayed table and click the row containing the pump of interest. The provided data entry fields will then display information describing the selected pump.

A new pump is added interactively on the Plan View using the **ADD PUMP** tool. To delete an existing pump, select the pump from the table and then click the Delete button. Click the Show button to zoom to a region around the currently selected pump in the Plan View, and then highlight the pump. Click the Report button to generate a Microsoft Excel report detailing all currently defined pump input data and any corresponding analysis results.

The following data are used to define a pump:

Pump ID

Enter the unique name (or ID) that is to be assigned to the pump being defined. This name can be alphanumeric (i.e., contain both numbers and letters), can contain spaces, is case insensitive (e.g., *ABC = abc*), and can be up to 128 characters in length. Therefore, the assigned name can be very descriptive, to assist you in identifying different pumps.

A new pump ID is automatically defined by the software when a new pump is added. However, the pump ID can be changed within this field.

When importing (or merging) multiple stormwater or sanitary sewer network models into a single model, the software will check for collisions between identical pump IDs and can automatically assign a new pump ID for any

pumps being imported that contain the same pump ID as already exist in the network model. See the section titled *Merging Network Models* on page 494 for more information.

Description (optional)

Enter an optional description that describes the pump being defined.

Initial Status

This radio button group is used to define the initial pump status at the start of the simulation. The following initial status are available:

- On (Open)** Pump is assumed running at the start of the simulation.
- Off (Closed)** Pump is assumed not to be running at the start of the simulation.

Pump Mode

This radio button group is used to define the pump mode to be used in the simulation. The following modes are available:

- Design** Acts as a transfer pump whose flow rate equals the inflow rate at its inlet node. No pump curve is required. The pump must be the only outflow link from its inlet node. Used mainly for preliminary design.
- Pump Curve** Used to define a relationship between a pump's flow rate and conditions at its inlet and outlet nodes. A pump curve is required to be defined.

Pump Type

This read-only field shows you the type of pump curve that is specified. The pump curve describes the relationship between a pump's flow rate and conditions at its inlet and outlet nodes. Four different types of pumps are supported, as shown below:

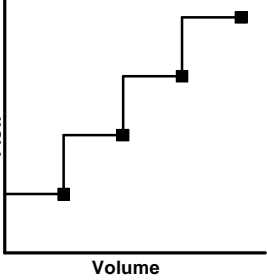
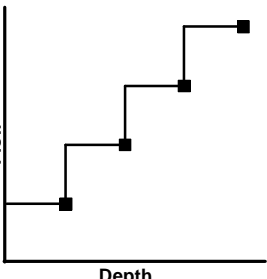
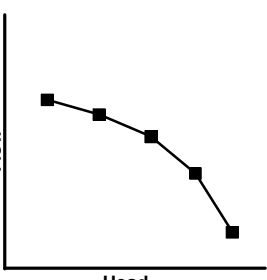
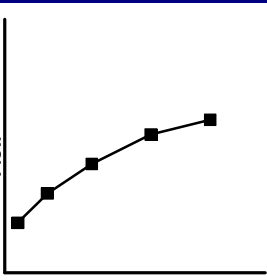
Type 1	Off-line pump with a wet well where flow increases incrementally with available wet well volume.	 A step function graph showing Flow on the y-axis and Volume on the x-axis. The flow rate remains constant at a low level until a certain volume is reached, then jumps to a higher constant level. This pattern repeats three times, showing an incremental increase in flow as volume increases.
Type 2	In-line pump where flow increases incrementally with inlet node depth.	 A step function graph showing Flow on the y-axis and Depth on the x-axis. The flow rate remains constant at a low level until a certain depth is reached, then jumps to a higher constant level. This pattern repeats three times, showing an incremental increase in flow as depth increases.
Type 3	In-line pump where flow varies continuously with head difference between the inlet and outlet nodes.	 A graph showing Flow on the y-axis and Head on the x-axis. The flow rate starts at a high value for low head and decreases as head increases, following a smooth, downward-sloping curve.
Type 4	Variable speed in-line pump where flow varies continuously with inlet node depth.	 A graph showing Flow on the y-axis and Depth on the x-axis. The flow rate starts at a low value for low depth and increases as depth increases, following a smooth, upward-sloping curve.

Pump Curve

A pump curve describes the relationship between a pump's flow rate and conditions at its inlet and outlet nodes. If a design pump is specified, then no pump curve is required.

From the drop-down list, select an already defined pump curve that contains the pump's operating data. Click the browse button to display the Pump Curves dialog box, which is described in detail in the next section, to define a new pump curve.

Operational Control

This check box enables operational control of the pump based upon the depth of water at the inlet node. Selecting the check box enables the **STARTUP DEPTH** and **SHUTOFF DEPTH** entries.

Startup Depth

This entry specifies at what depth of water at the inlet node that the pump should turn on.

Shutoff Depth

This entry specifies at what depth of water at the inlet node that the pump should turn off.

From (Inlet)

Node ID on the inlet side of the pump. Clicking the Swap button will switch the inlet and outlet nodes.



To (Outlet)

Node ID on the outlet side of the pump. Clicking the Swap button will switch the inlet and outlet nodes.

Control Rules

The on/off status of pumps can be controlled dynamically using the specified **STARTUP DEPTH** and **SHUTOFF DEPTH** entries, or by user-defined rules specified in the Control Rules dialog box. Control rules can also be used to simulate variable speed drives that modulate pump flow. More information on control rules can be found in the section titled *Control Rules* on page 442. Note that user-defined control rules have precedence over operational controls defined within the Pumps dialog box.

Pump Curves

The Pump Curves dialog box, as shown in the following figure, is displayed when a new pump performance curve is created or an existing pump performance curve is selected for editing. This curve relates flow through a pump to the depth or volume at the inlet node or to the head delivered by the pump. Select **INPUT** ► **PUMP CURVES** or double-click the **PUMP CURVES**  icon from the data tree to display the Pump Curves dialog box. This dialog box can also be displayed by clicking the  browse button from the **PUMP CURVE** data field in the Pumps dialog box (see page 263) when defining a pump performance curve.

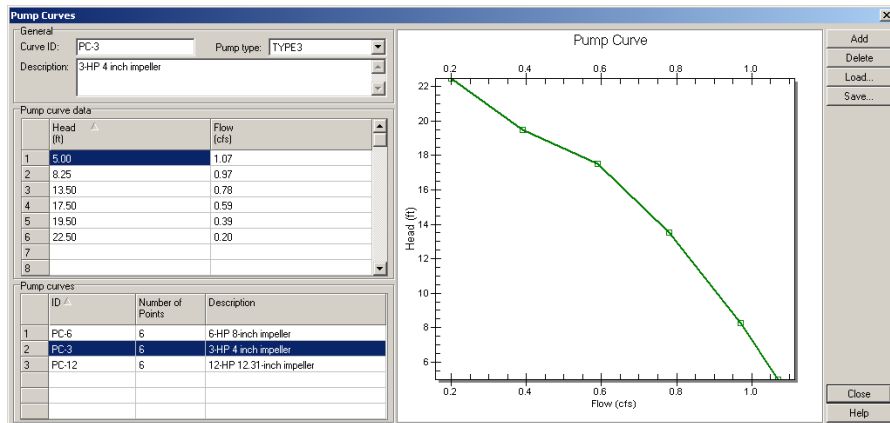

Figure 7.50 The Pump Curves dialog box

To select an existing pump performance curve, scroll through the pump curves table and click the row containing the pump performance curve of interest. The provided data definition table will then display the performance data describing the selected pump curve. In addition, a graphical plot of the pump performance is displayed for the selected pump curve. This graphical plot can be printed or exported, if desired. Right-click the graph and a context menu will be displayed, allowing you to print or export the graphic, as well as adjust the graphical plot.

To add a new pump performance curve, click the Add button and then enter the curve data in the data definition table. To delete a pump curve, select the pump curve from the pump curves table and then click the Delete button.

The following data are used to define a pump performance curve:

Pump Curve ID

Enter the unique name (or ID) that is to be assigned to the pump performance curve being defined. This name can be alphanumeric (i.e., contain both numbers and letters), can contain spaces, is case insensitive (e.g., *ABC = abc*), and can be up to 128 characters in length. Therefore, the assigned name can be very descriptive, to assist you in identifying different pump performance curves.

Description (optional)

Enter an optional comment or description of the pump performance curve.

Pump Type

This drop-down list allows you to select the type of pump being defined. A pump performance curve describes the relationship between a pump's flow rate and conditions at its inlet and outlet nodes. Four different types of pump curves are supported, as shown below:

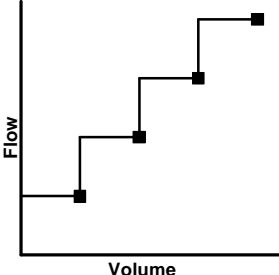
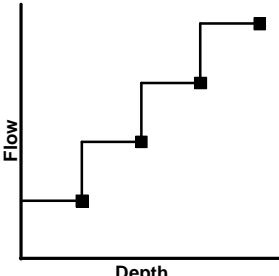
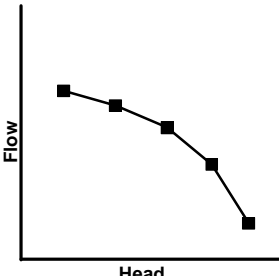
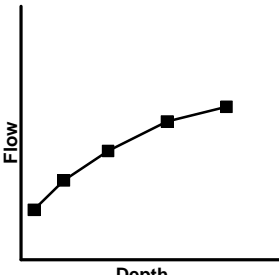
Type 1	Off-line pump with a wet well where flow increases incrementally with available wet well volume.	 A step function graph showing Flow on the y-axis and Volume on the x-axis. The flow remains constant at a low level until a certain volume is reached, then jumps to a higher level. This pattern repeats three times, showing an incremental increase in flow as volume increases.
Type 2	In-line pump where flow increases incrementally with inlet node depth.	 A step function graph showing Flow on the y-axis and Depth on the x-axis. The flow remains constant at a low level until a certain depth is reached, then jumps to a higher level. This pattern repeats three times, showing an incremental increase in flow as depth increases.
Type 3	In-line pump where flow varies continuously with head difference between the inlet and outlet nodes.	 A smooth, downward-sloping curve showing Flow on the y-axis and Head on the x-axis. The flow starts at a high value for low head and decreases as head increases, eventually leveling off.
Type 4	Variable speed in-line pump where flow varies continuously with inlet node depth.	 A smooth, upward-sloping curve showing Flow on the y-axis and Depth on the x-axis. The flow starts at a low value for low depth and increases as depth increases, eventually leveling off.

Volume vs. Flow (Pump Type 1)

Enter the pump curve's volume (ft^3 or m^3) versus flow (cfs or cms) curve data.

Flow vs. Depth (Pump Type 2 & 4)

Enter the pump curve's flow (cfs or cms) versus inlet node depth curve data.

Flow vs. Head (Pump Type 3)

Enter the pump curve's flow (cfs or cms) versus head difference (between the inlet and outlet nodes) curve data.

Right-Click Context Menu

Right-click the data table to display a context menu. This menu contains commands to cut, copy, insert, and paste selected cells in the table as well as options to insert or delete rows. The table values can be highlighted and copied to the clipboard for pasting into Microsoft Excel. Similarly, Excel data can be pasted into the pump performance table.

Importing and Exporting Pump Curve Data

Click the Load button to import a pump performance curve that was previously saved to an external file or click the Save button to export the current pump performance curve data to an external file.

Unit Conversion Problems



Note that changing the flow units of an existing network model (even within the same unit system, i.e., metric) can create conversion problems. This is due to the change in the units used to define pump curves. For example, changing the flow units from CMS to LPS in the Project Options dialog box (see page 163), will cause the pump curve input data requirements change from CMS to LPS. However, previously entered input data in CMS units will not automatically convert to LPS units. Therefore, the pumping rate of any previously defined pumps will change due to the flow unit change, and will make this change difficult to pinpoint in troubleshooting the model.

Storage Element Data

8

This chapter describes storage node related data, such as detention ponds, wet wells, and junction boxes used to define a stormwater or sanitary (wastewater) sewer model.



Storage Nodes

Storage nodes are network elements with associated storage volume. Physically they can represent storage facilities as small as a catchbasin, more commonly as a detention pond, and as large as a reservoir or lake. The volumetric properties of a storage node are described by a function or table of surface area versus height.

The principal input parameters for storage node include:

- Invert elevation
- Maximum depth
- Depth-surface area data
- Evaporation potential
- Ponded surface area when flooded (optional)
- External inflow data (optional)

The Storage Nodes dialog box, as shown in the following figure, is used to define a water retention structure, such as a detention pond, lake, reservoir, underground storage vault, or any other node element with storage characteristics.

The Storage Nodes dialog box is displayed when an existing storage node is selected for editing by double-clicking it in the Plan View using the **SELECT ELEMENT**  tool. Also, you can choose **INPUT**  **STORAGE NODES** or double-click the **STORAGE NODES**  icon from the data tree to display the Storage Nodes dialog box.

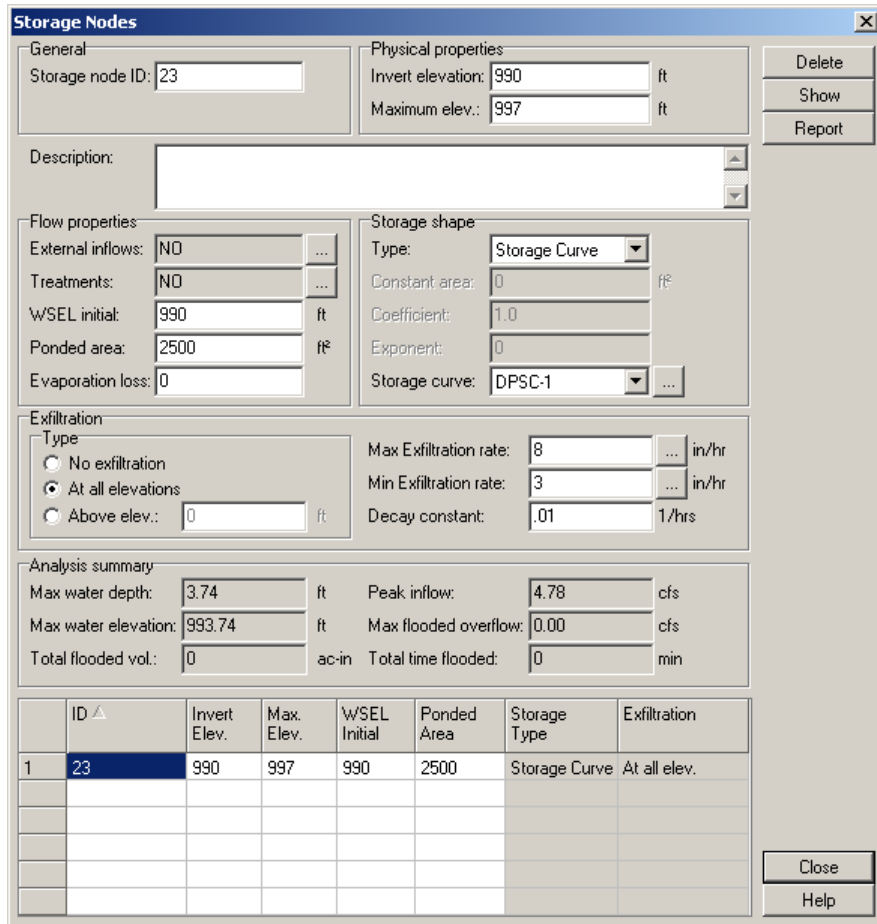



Figure 8.1 The Storage Nodes dialog box

To select a storage node, scroll through the displayed table and click the row containing the storage node of interest. The provided data entry fields will then display information describing the selected storage node.

A new storage node is added interactively on the Plan View using the **ADD STORAGE NODE**  tool. To delete an existing storage node, select the storage node from the table and then click the Delete button. Click the Show button to zoom to a region around the currently selected storage node in the Plan View, and then highlight the storage node. Click the Report button to generate a Microsoft Excel report detailing all currently defined storage node input data and any corresponding analysis results.

The following data are used to define a storage node:

Node ID

Enter the unique name (or ID) that is to be assigned to the storage node being defined. This name can be alphanumeric (i.e., contain both numbers and letters), can contain spaces, is case insensitive (e.g., *ABC = abc*), and can be up to 128 characters in length. Therefore, the assigned name can be very descriptive, to assist you in identifying different nodes.

A new node ID is automatically defined by the software when a new storage node is added. However, the node ID can be changed within this field.

When importing (or merging) multiple stormwater network models into a single model, the software will check for collisions between identical storage node IDs and can automatically assign a new node ID for any storage nodes being imported that contain the same node ID as already exist in the network model. See the section titled *Merging Network Models* on page 494 for more information.

Description (optional)

Enter an optional description that describes the storage node being defined.

Invert Elevation

This entry defines the bottom elevation of the storage node (ft or m).

Maximum Elevation (or Maximum Depth)

This entry defines the maximum elevation (or depth) of the storage node (ft or m). If a storage curve is defined, then this value should correspond to the maximum depth specified.

If defining a free surface storage element that can flood, such as a detention pond, then this value should be specified as the rim elevation of the detention pond and the entry **PONDED AREA** should be specified as to represent the area that can flood when this elevation (or depth) is exceeded.



If defining a storage vault that cannot flood and which will pressurize when the hydraulic head exceeds the roof of the vault, then this value should be specified high enough so that the computed hydraulic gradeline is less than this value. Then, when the computed hydraulic gradeline is greater than roof of the vault, the structure will pressurize. When the hydraulic gradeline exceeds this specified value, flooding is assumed to occur at the structure. In addition, to prevent numerical instability in the model when the structure pressurizes, a piezometric tube should be included in the storage volume definition of the storage vault for elevation values higher than the roof of the structure. Hence, the storage volume of the structure needs to be defined using a **STORAGE CURVE** in order to include varying storage area versus elevation data. The **FUNCTIONAL** storage volume definition option cannot be used. The defined storage curve data should include the definition of a piezometric tube (approximately 1 ft² in area should be sufficient) starting at the roof of the structure and continuing up to the maximum elevation (or depth) value specified.

Flow Properties Data

The following data entry fields are used to define the storage node flow properties.

External Inflows

Click the browse button to display the External Inflows for Node dialog box, which is described in detail on page 408. The External Inflows for Node dialog box defines the additional inflows entering the storage node, such as sanitary inflows. The following inflow types are available:

- Rainfall dependent infiltrations/inflows (RDII)
- User-defined (direct) inflows
- Dry weather inflows

Treatments

Click the browse button to display the Pollutant Treatments dialog box, which is described in detail on page 462. The Pollutant Treatments dialog box defines the treatment functions for pollutants entering the storage node.

WSEL Initial (or Initial Depth)

Elevation of the water in the storage node (or depth of water above the storage node invert) at the start of the simulation (ft or m).

Ponded Area

This entry defines the surface area (ft² or m²) occupied by ponded water atop the storage node once the water depth exceeds the maximum depth of the structure. If the **ENABLE OVERFLOW PONDING AT NODES** analysis option is turned on in the Project Options dialog box (see page 177), a non-zero value for this parameter will allow ponded water to be stored and subsequently returned to the drainage system when capacity exists.

Evaporation Loss

The decimal fraction (i.e., 0.15 equals 15%) of the potential evaporation from the detention pond's water surface that is actually realized.

Note that for very small time steps (less than 5 seconds) the computed evaporation will trend towards 0.0 when the pond is nearly dry. Hence a larger analysis time step may need to be specified.

Storage Shape Data

The following data entry fields are used to define the storage node's storage properties.

Type

This drop-down list allows you to select the method of describing the storage volume of the storage node being defined. The storage node volume is described by either:

Storage Curve From the Storage Curve drop-down list, select the storage curve that contains the tabular data of depth versus surface area (ft² or m²) or depth versus storage volume (ft³ or m³) for the storage node. Click the button to display the Storage Curves dialog box, described in the next section, to define a new storage curve.

Functional Specify the constant surface area (A), coefficient (B), and exponent (C) that describes the functional relationship between depth and surface area based upon the following expression:

$$\text{Area} = A + B * \text{Depth}^C$$

Note that this method is commonly used to define standard shaped (i.e., rectangular and circular) storage tanks and storage vaults. For these storage elements, only the **CONSTANT AREA** entry is specified—corresponding to the storage element's footprint in ft² or m². The coefficient B and exponent C values need to remain blank (or entered as 0).



Constant Area (Functional only)

This value denotes the constant surface area component (*A value*) in the functional method of defining the storage node surface area (in ft² or m²).

Note that this entry is commonly used to define constant area (i.e., vertical walled) storage structures, such as underground storage vaults and storage tanks. For example, if a storage vault with a footprint of 500 ft² is being defined, then 500 should be entered in this field and the coefficient B and exponent C values should remain blank (or entered as 0).

Coefficient (Functional only)

This value denotes the coefficient component (*B value*) in the functional method of defining the storage node surface area. This value is left blank or set to 0.0 when defining a fixed footprint (i.e., vertical walled) storage element—such as a storage tank or storage vault.

Exponent (Functional only)

This value denotes the exponent component (*C value*) in the functional method of defining the storage node surface area. This value is left blank or set to 0.0 when defining a fixed footprint (i.e., vertical walled) storage element—such as a storage tank or storage vault.

Storage Curve

This drop-down list allows you to select an already defined storage curve that contains the tabular data of depth versus surface area (ft² or m²) or depth versus storage volume (ft³ or m³) for the storage node. Click the browse button to display the Storage Curves dialog box, described in the next section, to define a new storage curve.

Exfiltration Data

The following data entry fields are used to define the detention pond (storage node element) exfiltration (sometimes called *infiltration*) properties. Note that this section will only be available if a **POND EXFILTRATION METHOD** is specified in the Project Options dialog box, General tab, described on page 176. This data are commonly used to define the flow properties of an infiltration basin.

Type

This radio button selection specifies when exfiltration losses will occur from the selected detention pond (storage node element).

- | | |
|-----------------------------------------|--------------------------------------------------------------------------------------------------------------------------------------------------------------------------------------------------------------------------------|
| No Exfiltration | No exfiltration losses will occur from the detention pond structure. This is the default selection. |
| At All Elevations | Exfiltration losses will be considered to occur for all water surface elevations within the detention pond structure. |
| Above Elevation (or Above Depth) | Exfiltration losses will occur above the specified elevation (or depth). This commonly occurs when there is a pond liner to maintain a minimum water surface elevation within the detention pond—such as a wet retention pond. |

Constant Flow Rate Exfiltration Method Data

This data is specified when the *Constant Flow* option is selected in the **POND EXFILTRATION METHOD** entry of the Project Options dialog box, General tab, described on page 176.

Constant Flow Rate

Specifies a constant flow rate (cfs or cms) for exfiltration losses from the detention pond during the entire routing simulation.

Constant Rate Exfiltration Method Data

This data is specified when the *Constant Rate* option is selected in the **POND EXFILTRATION METHOD** entry of the Project Options dialog box, General tab, described on page 176.

Exfiltration Rate

Specifies an average exfiltration rate (in/hr or mm/hr) for exfiltration losses from the detention pond during the entire routing simulation. This exfiltration rate is then multiplied by the appropriate surface area at the water surface elevation for each time step in order to determine the overall exfiltration rate from the pond. Note that the surface area method (*free surface area*, *projected area*, or *wetted area*) is specified by the **POND EXFILTRATION METHOD** entry of the Project Options dialog box, General tab. Depending upon the surface area method specified, as the water surface rises in the detention pond, a higher exfiltration loss occurs since more soil is in direct contact with the water in the pond.

Clicking the browse button will display the Typical Exfiltration Rates reference dialog box, as shown in the following figure, which lists typical steady-state exfiltration rates based upon soil group.

Horton Exfiltration Method Data

This data is specified when the *Horton* option is selected in the **POND EXFILTRATION METHOD** entry of the Project Options dialog box, General tab, described on page 176. The Horton equation is a widely-used method of representing the exfiltration rate of a soil. The Horton equation models a decreasing rate of exfiltration over time, which implies that the rate of exfiltration decreases as the soil becomes more saturated.

The exfiltration rate is computed for each time step during the routing using the Horton equation. This exfiltration rate is then multiplied by the appropriate surface area at the water surface elevation for each time step in order to determine the overall exfiltration rate from the pond. Note that the surface area method (*free surface area*, *projected area*, or *wetted area*) is specified by the **POND EXFILTRATION METHOD** entry of the Project Options dialog box, General tab. Depending upon the surface area method specified, as the water surface rises in the detention pond, a higher exfiltration loss occurs since more soil is in direct contact with the water in the pond.

Maximum Exfiltration Rate

Specifies the maximum (or *initial*) exfiltration rate (in/hr or mm/hr) at the start of the routing simulation to be used in the Horton equation to compute the exfiltration rate for each time step during the routing simulation. Singh (1992) recommends that the maximum exfiltration rate be taken as roughly 5 times the minimum exfiltration rate.

Clicking the browse button will display the Typical Exfiltration Rates reference dialog box, as shown in the following figure, which lists typical steady-state exfiltration rates based upon soil group.

Minimum Exfiltration Rate

Specifies the minimum (or *steady-state*) exfiltration rate (in/hr or mm/hr) to be used in the Horton equation to compute the exfiltration rate for each time step during the routing simulation. It can be shown theoretically that the steady-state exfiltration rate is equal to the saturated vertical hydraulic conductivity of the soil.

Clicking the browse button will display the Typical Exfiltration Rates reference dialog box, as shown in the following figure, which lists typical steady-state exfiltration rates based upon soil group.

Decay Constant

Specifies the infiltration rate decay constant (1/hours) to be used in the Horton equation to compute the exfiltration rate for each time step during the routing simulation. At time 0, the computed exfiltration rate is equal to the defined **MAXIMUM EXFILTRATION RATE**. As time progresses, the computed exfiltration rate decreases until finally reaching the **MINIMUM EXFILTRATION RATE**. Typical decay constants range between 2 and 7.

Typical Exfiltration Rates

Exfiltration rates can vary widely depending upon soil conditions and groundwater levels. Typical exfiltration rates are provided in the table below. Soil moisture levels, groundwater levels, and other factors can significantly reduce the actual exfiltration rate. For designs that are critically dependent upon the exfiltration rate, site testing is recommended.

Typical Exfiltration Rates			
USDA Soil Texture	Typical Infiltration Rate (inches/hour)	Typical Infiltration Rate (mm/hour)	Hydrologic Soil Group
Sand ¹	8.27	210.00	A
Loamy Sand ²	2.41	61.20	A
Sandy Loam ²	1.02	25.90	B
Loam ²	0.52	13.20	B
Silt Loam	0.27	6.86	C
Sandy Clay Loam	0.17	4.32	C
Clay Loam	0.09	2.29	D
Silty Clay Loam	0.06	1.52	D
Sandy Clay	0.05	1.27	D
Silty Clay	0.04	1.02	D
Clay	0.02	0.51	D

¹ Suitable for exfiltration with 6 to 8 ft separation from seasonal high groundwater
² Suitable for exfiltration with 3 ft separation from seasonal high groundwater

Using a Percolation Rate

A percolation rate can be converted to an equivalent exfiltration rate by the following equation:

$$\text{Exfiltration Rate} = 60 / \text{Percolation Rate}$$

Where:

Exfiltration Rate is in inches / hour
 Percolation Rate is in minutes per inch
 60 is the unit conversion factor

Figure 8.2 Typical Exfiltration Rates reference dialog box

Analysis Summary Section

The Storage Nodes dialog box provides a section titled **ANALYSIS SUMMARY** that provides a brief summary of the simulation results for the selected storage node, as shown in the following figure.

Above elev.: Deceleration: 1/hr

Analysis summary

Max water depth:	<input type="text" value="3.74"/>	ft	Peak inflow:	<input type="text" value="4.78"/>	cfs
Max water elevation:	<input type="text" value="993.74"/>	ft	Max flooded overflow:	<input type="text" value="0.00"/>	cfs
Total flooded vol.:	<input type="text" value="0"/>	ac-in	Total time flooded:	<input type="text" value="0"/>	min

ID ▲	Invert Elev.	Max. Elev.	WSEL Initial	Ponded Area	Storage Type	Exfiltration
23	990	997	990	2500	Storage Curve	At all elev.

Figure 8.3 The Analysis Summary section of the Storage Nodes dialog box

A description of the available analysis result fields is provided below:

Max Water Depth

This analysis output field provides the maximum water depth that occurred at the storage node during the simulation period.

Max Water Elevation

This analysis output field provides the maximum water elevation that occurred at the storage node during the simulation period.

Total Flooded Volume

This analysis output field provides the total volume of water that flooded out of (or ponded above) the storage node during the simulation period. This water may or may not have re-entered the storage node when the flooding subsided—depending upon the analysis options selected. See the section titled *Surface Ponding* on page 218 for more information.

Peak Inflow

This analysis output field provides the maximum flow rate of water entering the storage node during the simulation period.

Max Flooded Overflow

This analysis output field provides the maximum flow rate of water flooding (or ponding) from the storage node during the simulation period.

Total Time Flooded

This analysis output field provides the time, in minutes, that a storage node was flooded.

Infiltration Basin Considerations

Infiltration basins are depressions (either natural or excavated), into which stormwater is conveyed and then permitted to infiltrate into the underlying subsurface. Such basins can serve dual purposes as both infiltration (also called

exfiltration) and storage facilities (detention ponds). Below are some of the characteristics of infiltration basins and other infiltration devices:

- Infiltration basins are particularly effective for small drainage areas where the water table is deep and the soil is porous.
- They offer the advantage of low maintenance if they are properly designed and sediment is removed from the stormwater by some type of pretreatment before it enters the infiltration basin.
- Pollutant removal is very high for infiltration devices as many pollutants are biologically consumed in the soil, including plant nutrients (fertilizers).
- Infiltration provides recharge for ground water, similar to that which occurred before the area was developed. This added recharge water will supplement the water available in the deeper geologic zones and also help to maintain flow in streams during dry weather.
- Many infiltration devices are located underground so that little or no land area is lost and there are no unsightly structures in view. This allows underground infiltration devices to be located close to impermeable areas where the runoff volumes and the pollutant loads are high.
- Infiltration basins resemble detention ponds except that all stormwater exits by entering the soil. These open basins can only be used where the soil is very permeable.
- Infiltration trenches have a number of differing designs, depending on location and use. Generally, a trench from 3 to 8 feet deep is filled with coarse rock to the ground surface. The voids between the coarse rock fill with water, which then infiltrates into the soil. Stormwater is directed to the trench by grassed filter strips or grassed swales, which remove the sediment.
- Underground trenches and dry wells are constructed similarly to the infiltration trenches, but are covered with soil and grass, thus greatly improving their appearance and acceptance in residential neighborhoods. Because access to these devices is difficult once they are installed, they must be protected by inlet devices which remove sediment to prevent clogging and failure.
- Infiltration basins may be integrated into open spaces and park lands in urban areas. In highway design, infiltration basins may be located in the right-of-way or in the open space within freeway interchange loops.
- The main disadvantage of infiltration devices is that they will fail quickly if the incoming water contains sediment. The sediment will clog the soil, requiring complete replacement or rebuilding of the device. Thus, infiltration devices should have some pretreatment device, such as a filter strip, to remove sediment before the stormwater enters. Underground devices require special inlets to remove both sediment and trash.
- Infiltration basins can also present problems with standing water and insect breeding.
- Infiltration devices are extremely dependent on the type of soil in the area. The soil often becomes a limiting factor in choosing to use infiltration. Although there are many designs and devices being tried, the majority of infiltration devices appear to have very short life spans. More development is needed to design infiltration devices with better longevity.

Underground Storage Facilities

In areas where surface detention ponds are either not permitted or not feasible, underground detention can be used. Excess stormwater runoff can be

accommodated in some form of storage tank, either in-line or off-line, which will then discharge at a pre-determined flow rate back into either the sewer system or open watercourse.

In-line detention incorporates the storage facility directly into the sewer system. If the capacity of the underground in-line storage facility is exceeded, it can result in sewer surcharging.

Off-line detention collects stormwater runoff before entering the drainage system, and then discharges either into a sewer or open watercourse at a controlled rate.

By using a major sewer system and connecting all tributary catch basins to a underground detention tank, approximately 80% of stormwater runoff may be prevented from directly entering the conventional sewer system. In areas where roof drains are discharged to the surface, close to 100% of the stormwater runoff can be controlled. Such detention facilities are very applicable in areas with combined sewer systems. Stormwater is then collected in the underground detention tanks and then discharged back to the combined sewer at a slower, controlled rate.

Non-Standard Junctions

Junctions have limited storage volume as nodal elements within a network model, and are assumed to have the volume only of a common manhole. This storage volume defaults to a 4 ft diameter circular manhole, and is defined by the entry **JUNCTION SURFACE AREA** in the Analysis Options dialog box, General tab, described on page 74. Therefore, if it is necessary to model a underground storage vault or other nodal element with significant storage properties, use a storage node element. A storage node can model more than just commonplace ponds—they can model any nodal element that has particular storage properties—such as junction boxes. However, if the node's storage characteristics are similar to that of a junction, it is adequate to represent the node simply as a junction.

Minimum Drain Time

There may be a regulatory requirement of a minimum drain time as a performance criteria in order to judge a proposed detention pond's effectiveness at improving stormwater water quality. Settling-solids analysis shows that detention ponds that retain stormwater longer improve the removal of total suspended sediments (TSS) and other pollutants. For example, the design requirement may be that the pond should be designed to drain from completely full in not less than a specified minimum time period (e.g., 12 hours). Because the stored volume of water, water depth, and discharge from the pond vary over time as the pond drains, a hydraulic routing is required to compute the minimum drain time.

To compute the minimum drain time, define an initial water surface elevation (**WSEL INITIAL**) equal to the pond maximum design elevation (**MAXIMUM ELEVATION**). Then, define a storm event with no precipitation and assign it to the subbasins in order that there is no storm runoff from the subbasins and therefore no additional runoff into the proposed detention pond. (If there was additional runoff inflow into the detention pond, then the drain time would become longer.) Then, define a routing period in the Analysis Options dialog box (see page 69) long enough to route the stored water out of the detention pond (i.e., 24 hours). Then, perform the analysis and review the graphical plot of head at the proposed detention pond. This graph will show the depth of water in the pond over time, and can be used to gage the effectiveness of the proposed detention pond for the minimum drain time requirement. The time required to completely drain the pond is the minimum drain time.

The following figure illustrates how the water surface elevation at a proposed detention pond drops over time, as different outfall structures (i.e., weirs and orifices) discharge water from the pond. Notice that at time = 0 the water surface elevation is equal to the pond maximum design elevation.

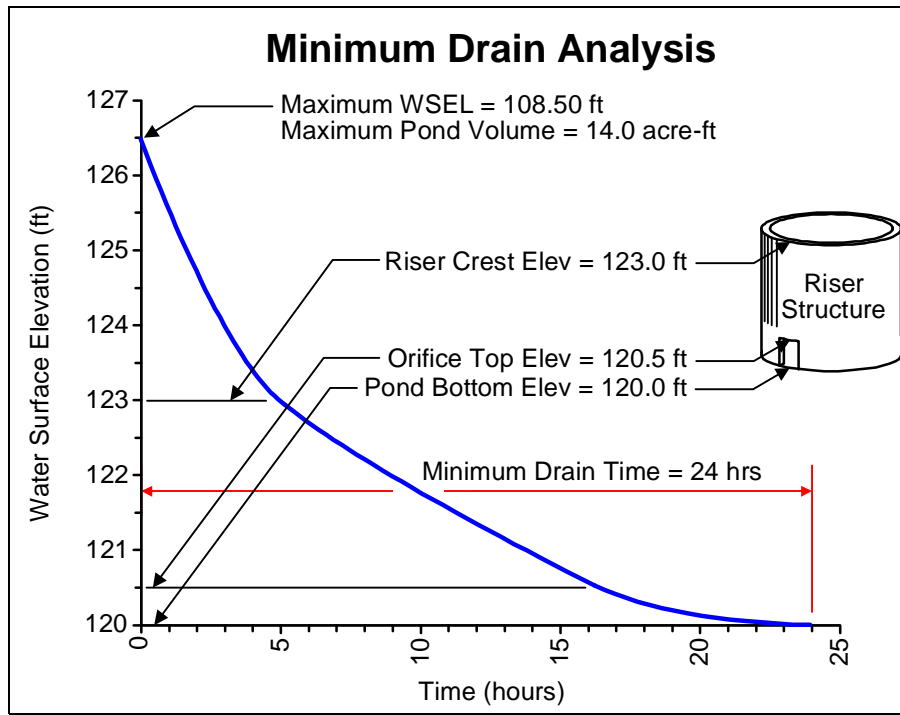

Figure 8.4 Graph illustrating the minimum drain time for a proposed detention pond

Regulatory requirements may also stipulate a percentage of total retained volume of water versus time. For example, it can be relatively easy to meet the minimum drain time requirement by designing a small drain orifice at the bottom of the pond. However, if the bulk of the detained stormwater is released relatively shortly after being captured by the proposed detention pond, then the detention pond is not doing an effective job at improving the discharged stormwater's water quality. Therefore, additional design work may be required to develop the pond outfall structure, and perhaps increase the detention pond size, in order to detain the stormwater over a long enough time period to meet these requirements. The software can plot volume versus time (see the following figure), which can then be used to determine whether the proposed detention pond design meets the drain volume requirement.

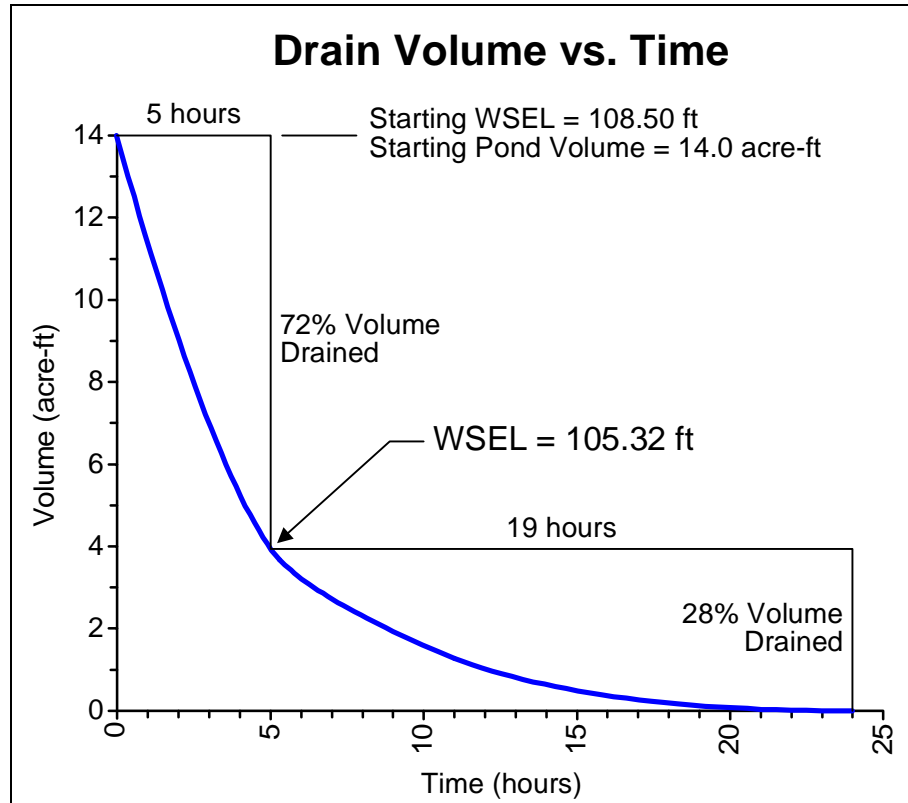



Figure 8.5 Drain volume versus time

Estimating First Flush Volume

Control of the "first flush" is important in stormwater management because most water quality contaminants are transported from impervious surfaces during the initial stages of a storm event. From 70% to 95% of the contaminants in stormwater runoff can be removed by capturing the first flush (generally considered the first 1 inch) of stormwater runoff through infiltration practices. Many municipalities have adopted regulations that require new and redeveloped areas to treat the first flush of stormwater runoff prior to discharging it into streams and lakes. Methods commonly used to treat this first flush include stormwater detention structures, oil/grit separators, rain gardens, grass swales, infiltration trenches, water quality ponds, and commercial stormwater products.

The software can be used to size these stormwater detention structures for the first flush of stormwater runoff to capture the initial flow and then provide sufficient detention time to allow settling of the particulate matter.

Storage Curves

The Storage Curves dialog box, as shown in the following figure, is displayed when a new storage curve is created or an existing storage curve is selected for editing. This curve describes how the surface area and storage volume of the storage node varies with water depth. Select **INPUT** ► **STORAGE CURVES** or double-click the **STORAGE CURVES**  icon from the data tree to display the Storage Curves dialog box. This dialog box can also be displayed by clicking the  browse button from the **STORAGE CURVE** data field in the Storage Nodes dialog box (see page 270) when defining a storage node (e.g., detention pond).

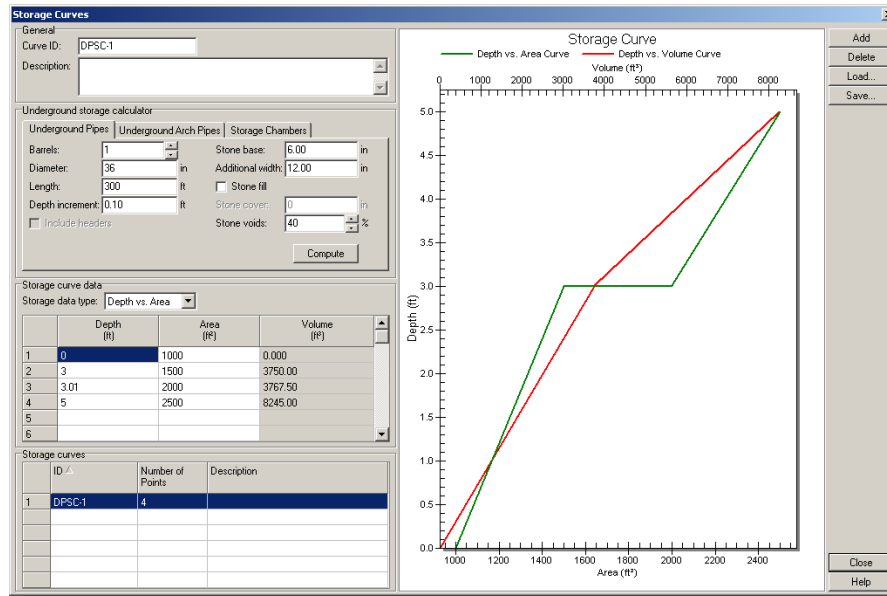

Figure 8.6 The Storage Curves dialog box

The Storage Curves dialog box allows you to enter the storage data by either surface area or storage volume. As you enter the data, a graphical plot of surface area and storage volume versus depth is displayed showing the storage characteristics of the defined storage node. This graphical plot can be printed or exported, if desired. Right-click the graph and a context menu will be displayed, allowing you to print or export the graphic, as well as adjust the graphical plot.

On-Site Underground Detention/Retention

In addition to above ground detention ponds, detention storage can also be provided by underground tanks, vaults, pipes, or storage chambers. This allows land to be used for other purposes rather than for creating an above ground detention pond, freeing up land for development. This can be particularly important for space-limited areas where there is not adequate land for a detention pond. The underground storage structure can be placed on the property, perhaps underneath a parking lot, to provide water quantity control through detention and/or extended detention for the stormwater runoff.

For the underground storage of stormwater, riser pipes and curb inlets can drain surface stormwater to subsurface vaults or systems of large diameter interconnected storage pipes or chambers. Stored water can then be released directly through an outlet pipe back into natural waters at rates designed to reduce peak flows during storms to mimic pre-development conditions. In some cases, stored water can be allowed to infiltrate in order to recharge groundwater (if underlying soil types are suitable and the groundwater table is located sufficiently below the subsurface storage units). See the following illustration for an example of a pipe-based underground stormwater detention system.

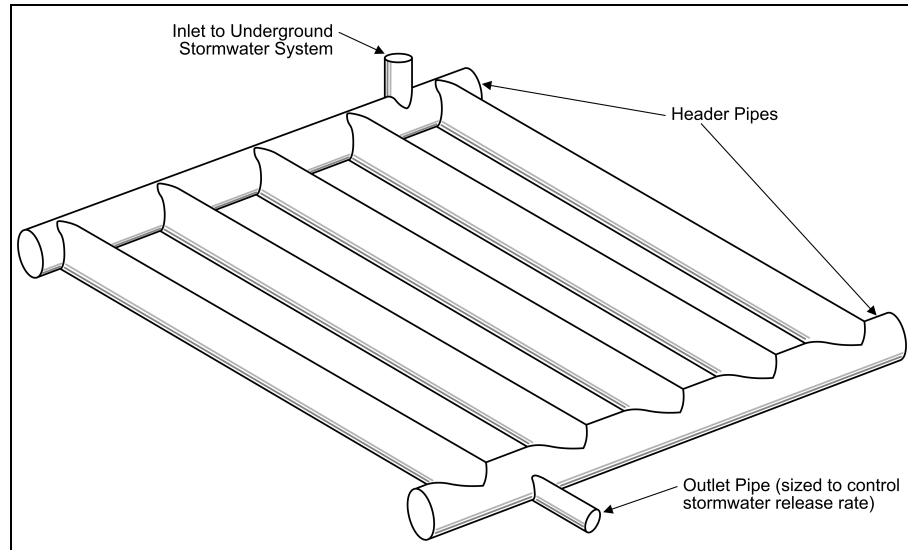

Figure 8.7 Schematic of a pipe-based underground stormwater detention system

Underground stormwater storage provides minimal stormwater quality benefits, but can be a successful part of a development's overall stormwater management plan, especially when coupled in-line with other stormwater BMPs. The addition of pretreatment features at the system's inlet can facilitate improvements to water quality by removing floatables, skimming of oils and grease, and trapping of some level of sediments through deposition. Pretreatment is most important if the stored water is to be allowed to infiltrate into the soil, otherwise rapid clogging of the system could occur. Pretreatment features can be designed and built into the system, as well as there are commercially available prefabricated units that can be incorporated within the system during initial planning and design.

Subsurface storage relies on stormwater storage structures made of concrete (vaults) or large diameter, rigid pipes or arches with capped ends constructed of plastic, steel, or aluminum. A number of pre-built, modular systems are also commercially available. The Storage Curves dialog box provides the ability to compute the storage volumes for underground storage pipes, arched pipes, and most commercially available pre-built modular storage chambers.

Generally, the underground storage structures, inlet and outlet pipes, and maintenance access (manholes) are constructed in an excavated area and then back-filled to the surrounding landscape surface height with pea gravel (or equivalent fill material) and subsequently surfaced. Because of on going maintenance requirements and the potential of needed repairs at some later date, underground storage facilities should not be underneath a fixed structure and should preferably be located in areas where large sized maintenance vehicles can easily operate and excavation can be performed (if required).

Storage Curve Data

To select an existing storage curve, scroll through the storage curves table and click the row containing the storage curve of interest. The provided data definition table will then display the depth versus surface area and storage volume data describing the selected storage curve.

To add a new storage curve, click the Add button and then enter the curve data in the data definition table. To delete a storage curve, select the storage curve from the storage curves table and then click the Delete button.

The following data are used to define a storage curve:

Storage Curve ID

Enter the unique name (or ID) that is to be assigned to the storage curve being defined. This name can be alphanumeric (i.e., contain both numbers and letters), can contain spaces, is case insensitive (e.g., *ABC = abc*), and can be up to 128 characters in length. Therefore, the assigned name can be very descriptive, to assist you in identifying different storage curves.

Description (optional)

Enter an optional comment or description of the storage curve.

Underground Storage Pipes

As shown in the following figure, selecting the **UNDERGROUND PIPES** tab of the Underground Storage Calculator section of Storage Curves dialog box, you can define the data to be used to compute the available storage area (ft^2 or m^2) and storage volume (ft^3 or m^3) for an underground pipe stormwater detention system. After entering the data defining the underground pipe detention system, click the Compute button and the software will calculate the corresponding detention storage area and volume and place this information in the storage curve data table.

Underground Pipes		Underground Arch Pipes		Storage Chambers	
Barrels:	1	Stone base:	6.00	in	
Diameter:	36	Additional width:	12.00	in	
Length:	300	<input type="checkbox"/> Stone fill			
Depth increment:	0.10	Stone cover:	0	in	
<input type="checkbox"/> Include headers		Stone voids:	40	%	
Compute					

Storage curve data

Storage curve data	Storage curve data
Storage curve data	Storage curve data

Figure 8.8 Underground storage pipes definition

Barrels

This spin control specifies how many identical, parallel underground storage pipes are being defined.

Diameter

Diameter (ft/inches or m/cm) of the underground storage pipe being defined.

Length

Length (ft or m) of the underground storage pipe being defined. See Figure 8.7 for an illustration of this value.

Depth Increment

This data entry specifies how detailed a storage curve should be computed. A default value of 0.10 ft (or m) is used, which corresponds to a storage curve computed in 0.10 ft (or m) depth increments.

Include Headers

This check box is used to denote whether both upstream and downstream header pipes (or manifolds) are used to distribute stormwater to the underground storage pipes, as shown in Figure 8.7. By default, no header is defined.

If a header is defined, then it is assumed that the header pipes are constructed with the same diameter pipe as used to construct the underground storage pipes. The software will then include the additional storage volume for the headers when computing the detention storage area and volume. Headers are assumed to be placed at both ends of the underground storage pipes.

Stone Base

This entry specifies the base thickness (ft/inches or m/cm) of the stone fill (pea gravel or equivalent fill material) that is constructed underneath the underground storage pipes and headers (if defined), as shown in Figure 8.9. This stone base is assumed to be as wide as the diameter of the underground storage pipe and underlays both the pipe and any headers (if defined). If an **ADDITIONAL WIDTH** is specified, then the stone base width is increased by this amount. This stone base is then used in calculating the available detention storage area and volume.

Additional Width

This entry specifies the additional width (ft/inches or m/cm) that stone fill is used for the stone base, and optionally around the sides and cover of the underground storage pipe, as shown in Figure 8.9.

For example, if a 3 ft diameter underground storage pipe and an additional width of 4 ft is specified, then there is an additional 2 ft of stone fill on both sides of the underground storage pipe. Note that this additional width is also included for the header pipes (if defined) and increases the length of the header pipes because of the increased gap between the parallel underground storage pipes due to the additional fill material.

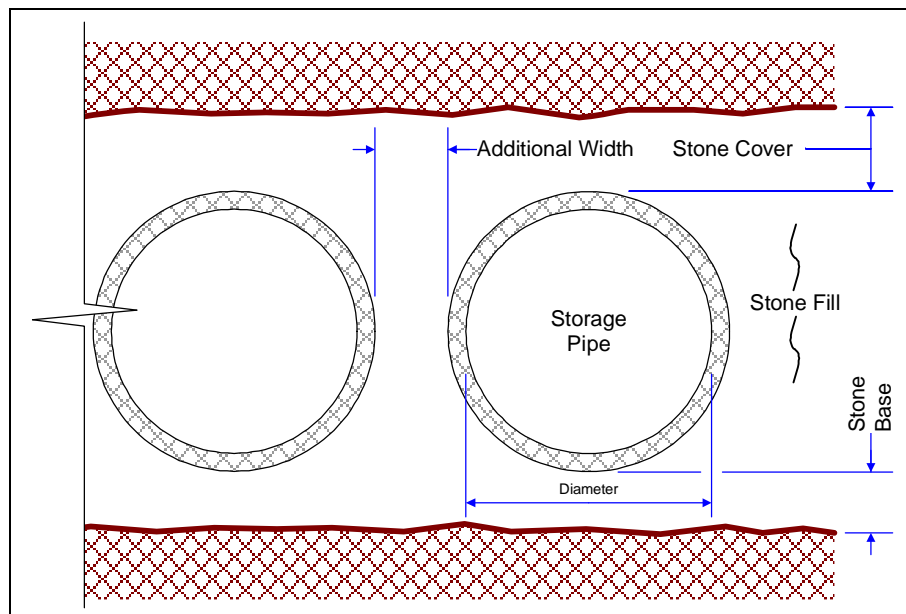

Figure 8.9 Underground storage pipe dimensions

Stone Fill

This check box is used to denote whether additional stone fill is used around the sides of the underground storage pipes. By default, no additional stone fill is provided.

If stone fill is defined, then the stone fill is assumed to extend outward from the pipe to a total width equal to the pipe diameter + additional width, as with a rectangular “box-style” excavation (or galley) containing both the underground storage pipe and stone fill.

If no additional width is specified, then the stone fill extends out equal to the pipe diameter.

Stone Cover

This entry specifies the cover thickness (ft/inches or m/cm) of the stone fill (pea gravel or equivalent fill material) that is constructed above the underground storage pipe and header (if defined), as shown in Figure 8.9. This stone cover is assumed to be as wide as the diameter of the underground storage pipe and overlays both the pipe and any headers (if defined). If an **ADDITIONAL WIDTH** is specified, then the stone cover width is increased by this amount. This stone cover is then used in calculating the available detention storage area and volume.

Stone Voids

This entry specifies the void space within the stone fill (pea gravel or equivalent fill material), in percentage. For example, 40% void space means that within 1 ft³ cubic volume of stone fill material, 0.40 ft³ is available for storing stormwater. The default void space is 40%.

Underground Storage Arch Pipes

As shown in the following figure, selecting the **UNDERGROUND ARCH PIPES** tab of the Underground Storage Calculator section of Storage Curves dialog box, you can define the data to be used to compute the available storage area (ft² or m²) and storage volume (ft³ or m³) for an underground arch pipe stormwater detention system. After entering the data defining the underground arch pipe detention system, click the Compute button and the software will calculate the corresponding detention storage area and volume and place this information in the storage curve data table.

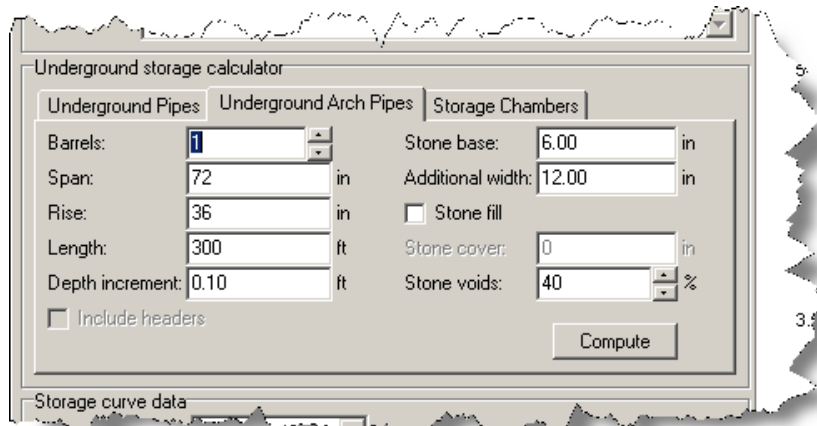

Figure 8.10 Underground storage arch pipes definition

Barrels

This spin control specifies how many identical, parallel underground storage arch pipes are being defined.

Span

Base width (ft/inches or m/cm) of the underground storage arch pipe being defined.

Rise

Height (ft/inches or m/cm) of the underground storage arch pipe being defined.

Length

Length (ft or m) of the underground storage arch pipe being defined. See Figure 8.7 on page 283 for an illustration of this value.

Depth Increment

This data entry specifies how detailed a storage curve should be computed. A default value of 0.10 ft (or m) is used, which corresponds to a storage curve computed in 0.10 ft (or m) depth increments.

Include Headers

This check box is used to denote whether both upstream and downstream header arch pipes (or manifolds) are used to distribute stormwater to the underground storage arch pipes, as shown in Figure 8.7 on page 283. By default, no header is defined.

If a header is defined, then it is assumed that the header arch pipes are constructed with the same arch pipe as used to construct the underground storage arch pipes. The software will then include the additional storage volume for the headers when computing the detention storage area and volume. Headers are assumed to be placed at both ends of the underground storage arch pipes.

Stone Base

This entry specifies the base thickness (ft/inches or m/cm) of the stone fill (pea gravel or equivalent fill material) that is constructed underneath the underground storage arch pipes and headers (if defined), as shown in Figure 8.11. This stone base is assumed to be as wide as the span of the underground storage arch pipe and underlays both the arch pipe and any headers (if defined). If an **ADDITIONAL WIDTH** is specified, then the stone base width is increased by this amount. This stone base is then used in calculating the available detention storage area and volume.

Additional Width

This entry specifies the additional width (ft/inches or m/cm) that stone fill is used for the stone base, and optionally around the sides and cover of the underground storage arch pipe, as shown in Figure 8.11.

For example, if a 3 ft span underground storage arch pipe and an additional width of 4 ft is specified, then there is an additional 2 ft of stone fill on both sides of the underground storage arch pipe. Note that this additional width is also included for the header pipes (if defined) and increases the length of the header pipes because of the increased gap between the parallel underground storage arch pipes due to the additional fill material.

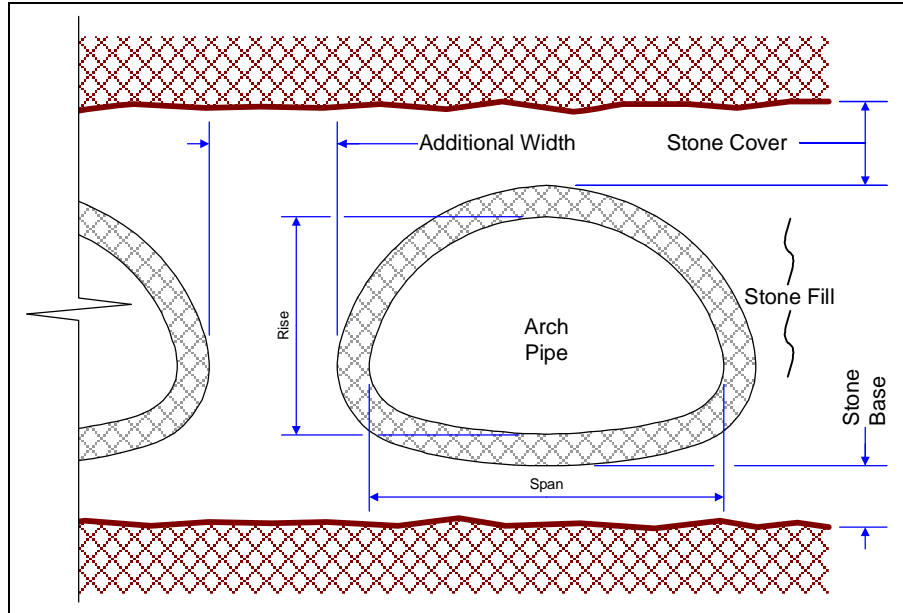

Figure 8.11 Underground storage arch pipe dimensions

Stone Fill

This check box is used to denote whether additional stone fill is used around the sides of the underground storage arch pipes. By default, no additional stone fill is provided.

If stone fill is defined, then the stone fill is assumed to extend outward from the arch pipe to a total width equal to the pipe span (base width) + additional width, as with a rectangular “box-style” excavation (or galley) containing both the underground storage arch pipe and stone fill.

If no additional width is specified, then the stone fill extends out equal to the arch pipe span (base width).

Stone Cover

This entry specifies the cover thickness (ft/inches or m/cm) of the stone fill (pea gravel or equivalent fill material) that is constructed above the underground storage arch pipe and header (if defined), as shown in Figure 8.11. This stone cover is assumed to be as wide as the span (base width) of the underground storage arch pipe and overlays both the arch pipe and any headers (if defined). If an **ADDITIONAL WIDTH** is specified, then the stone cover width is increased by this amount. This stone cover is then used in calculating the available detention storage area and volume.

Stone Voids

This entry specifies the void space within the stone fill (pea gravel or equivalent fill material), in percentage. For example, 40% void space means that within 1 ft³ cubic volume of stone fill material, 0.40 ft³ is available for storing stormwater. The default void space is 40%.

Underground Storage Chambers

Underground stormwater storage chambers, as shown in the following figure, are designed as an open bottom, interlocking, high-density polyethylene infiltration chambers which function in both permeable and non-permeable soils for subsurface retention or detention of stormwater runoff and for a water quality

BMP. Several manufacturers of these devices are available, with the software supporting all major manufacturers.



Figure 8.12 Installation of an underground stormwater storage chamber system

As shown in the following figure, selecting the **STORAGE CHAMBERS** tab of the Underground Storage Calculator section of Storage Curves dialog box, you can define the data to be used to compute the available storage area (ft^2 or m^2) and storage volume (ft^3 or m^3) for an underground storage chamber stormwater detention system. After entering the data defining the underground storage chamber detention system, click the Compute button and the software will calculate the corresponding detention storage area and volume and place this information in the storage curve data table.

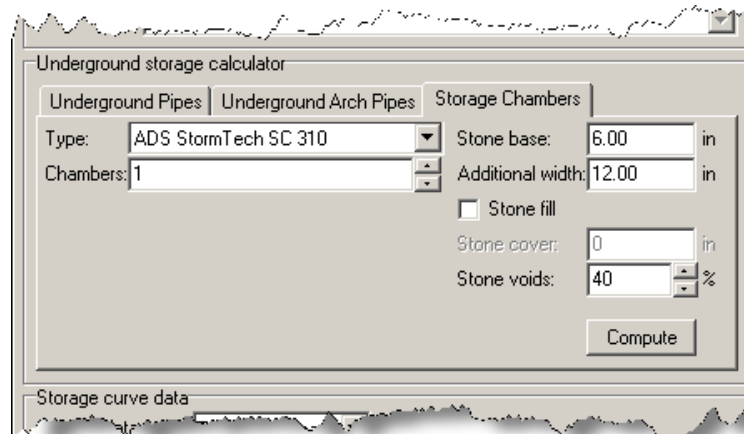

Figure 8.13 Underground storage chambers definition

Type

This drop-down list allows you to select the storage chamber manufacturer and model number in order to determine the detention storage characteristics of the storage chamber.

Chambers (ADS and HydroLogic only)

This spin control specifies how many identical storm chambers are being defined for detention storage. Note that this entry applies for ADS and HydroLogic storage chambers. Cultec storage chambers are defined by length.

Length (Cultec only)

Total length (ft or m) of all the storage chambers being defined. Note that this entry only applies for Cultec storage chambers. ADS and HydroLogic storage chambers are defined by number of chambers.

Stone Base

This entry specifies the base thickness (ft/inches or m/cm) of the stone fill (pea gravel or equivalent fill material) that is constructed underneath the underground storage chambers, as shown in Figure 8.14. This stone base is assumed to be as wide as the storage chamber base width. If an **ADDITIONAL WIDTH** is specified, then the stone base width is increased by this amount. This stone base is then used in calculating the available detention storage area and volume.

Additional Width

This entry specifies the additional width (ft/inches or m/cm) that stone fill is used for the stone base, and optionally around the sides and cover of the underground storage chamber, as shown in Figure 8.14.

For example, if a 3 ft wide underground storage chamber and an additional width of 4 ft is specified, then there is an additional 2 ft of stone fill on both sides of the underground storage chamber.

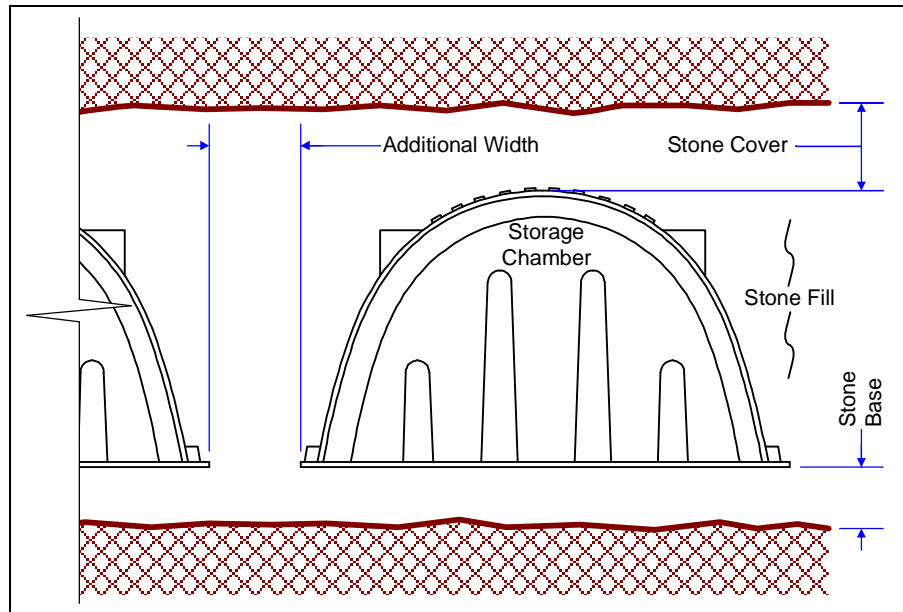

Figure 8.14 Underground storage chamber dimensions

Stone Fill

This check box is used to denote whether additional stone fill is used around the sides of the underground storage chamber. By default, no additional stone fill is provided.

If stone fill is defined, then the stone fill is assumed to extend outward from the storage chamber to a total width equal to the chamber width + additional width, as with a rectangular “box-style” excavation (or galley) containing both the underground storage chamber and stone fill.

If no additional width is specified, then the stone fill extends out equal to the storage chamber base width.

Stone Cover

This entry specifies the cover thickness (ft/inches or m/cm) of the stone fill (pea gravel or equivalent fill material) that is constructed above the underground storage chamber, as shown in Figure 8.14. This stone cover is assumed to be as wide as the storage chamber base width. If an **ADDITIONAL WIDTH** is specified, then the stone cover width is increased by this amount. This stone cover is then used in calculating the available detention storage area and volume.

Stone Voids

This entry specifies the void space within the stone fill (pea gravel or equivalent fill material), in percentage. For example, 40% void space means that within 1 ft³ cubic volume of stone fill material, 0.40 ft³ is available for storing stormwater. The default void space is 40%.

Depth vs. Area Storage Curve Data

As shown in the following figure, selecting **DEPTH VS. AREA** from the **STORAGE DATA TYPE** drop-down list in the Storage Curves dialog box allows you to enter the storage curve’s depth (ft or m) versus area (ft² or m²) curve data. As you enter surface area data, the equivalent storage volume is computed. Right-click the data table to display a context menu. This menu contains commands to cut, copy, insert, and paste selected cells in the table as well as options to insert or delete rows.

Note that this table is filled automatically when you click the Compute button of the Underground Storage Calculator section of Storage Curves dialog box after defining the underground storage pipes, arch pipes, or storage chambers data.

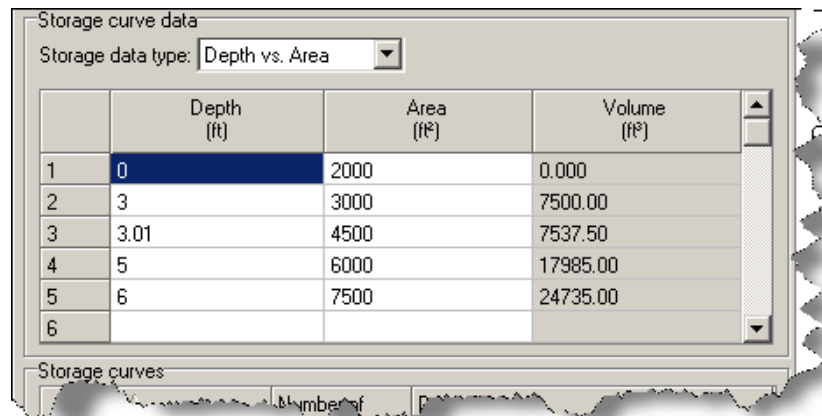

	Depth (ft)	Area (ft ²)	Volume (ft ³)
1	0	2000	0.000
2	3	3000	7500.00
3	3.01	4500	7537.50
4	5	6000	17985.00
5	6	7500	24735.00
6			

Figure 8.15 Depth vs. area storage curve data definition

Depth vs. Volume Storage Curve Data

As shown in the following figure, selecting **DEPTH VS. VOLUME** from the **STORAGE DATA TYPE** drop-down list in the Storage Curves dialog box allows you to enter the storage curve's depth (ft or m) versus volume (ft³ or m³) curve data. As you enter volume data, the equivalent storage surface area is computed. Right-click the data table to display a context menu. This menu contains commands to cut, copy, insert, and paste selected cells in the table as well as options to insert or delete rows.

	Depth (ft)	Area (ft ²)	Volume (ft ³)
1	0	1000	0
2	3	2000.00	4500
3	3.01	2003.32	4520
4	5	3800.00	12000
5			
6			

Figure 8.16 Depth vs. volume storage curve data definition

Unique Elevation Values Required



Note that the software requires unique elevation values when specifying detention storage by either surface area or volume. In this situation there are two surface areas corresponding to the same elevation value and the analysis engine could run into computational convergence issues if the computed water surface elevation is near this value. Therefore, in the event that the detention pond has a horizontal safety ledge, you need to adjust one of the elevation values up or down by a small amount (e.g., 0.001 ft) and the model will run. However, if duplicate elevation values are encountered in the storage node definition data, the software will issue an error message and terminate the analysis.

Importing and Exporting Storage Curve Data

Click the Load button to import a storage curve that was previously saved to an external file or click the Save button to export the current storage curve data to an external file.

Right-Click Context Menu

Right-click the data table to display a context menu. This menu contains commands to cut, copy, insert, and paste selected cells in the table as well as options to insert or delete rows. The table values can be highlighted and copied to the clipboard for pasting into Microsoft Excel. Similarly, Excel data can be pasted into the storage curve data table.

Orifices

Orifices are used to model outlet and diversion structures in drainage systems, which are typically openings in the wall of a manhole, detention pond, or control gate. They are internally represented as a link connecting two nodes. An orifice can

have either a circular or rectangular shape, be located either at the bottom or along the side of the upstream node, and have a flap gate to prevent backflow.

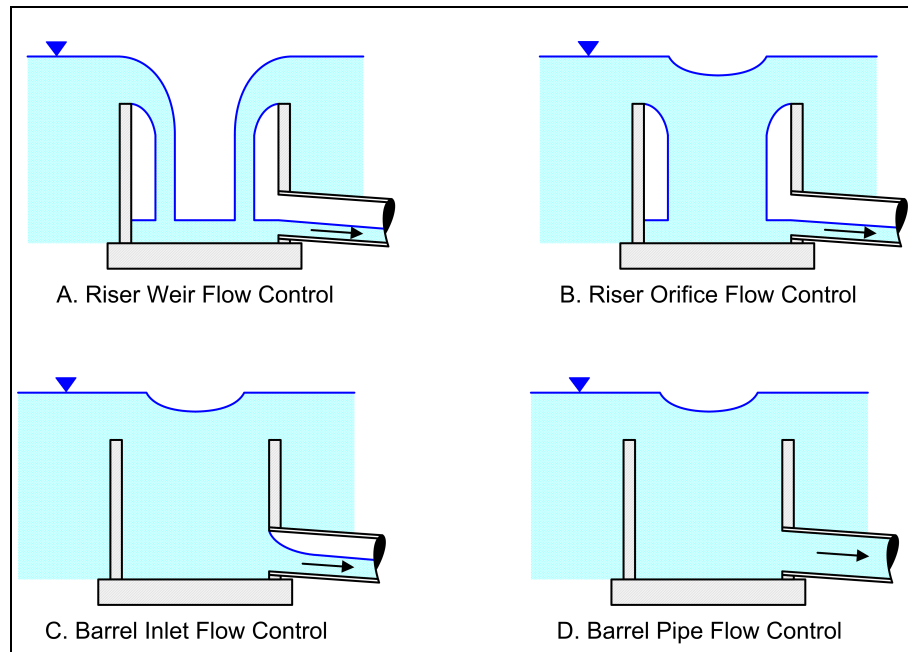

Figure 8.17 Riser pipe flow as computed by the software

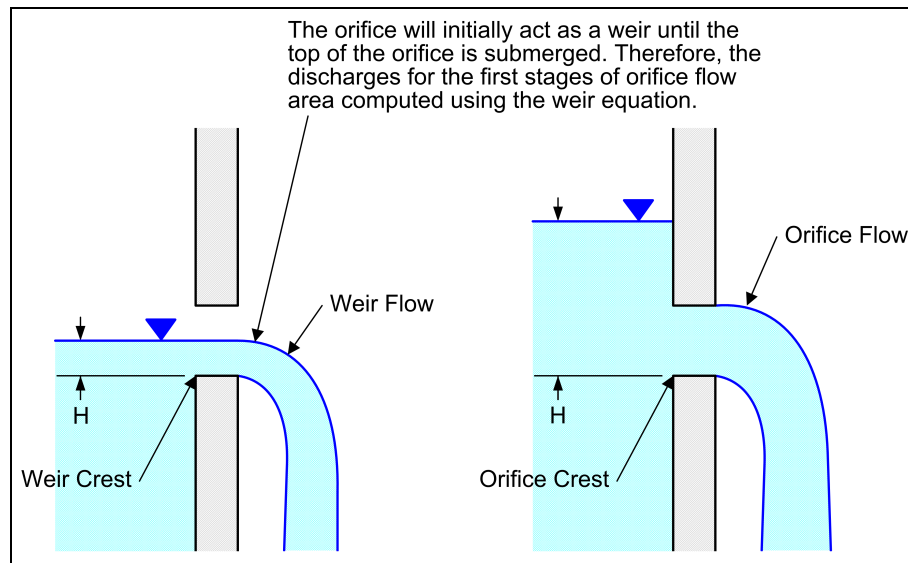

Figure 8.18 Orifice flow as computed by the software

Orifices can be used as storage node (e.g., detention pond) outlets under all types of flow routing. If not attached to a storage node, they can only be used in drainage networks that are analyzed with Hydrodynamic Routing. The orifice flow computed by the software can account for tailwater submergence effects.

As shown in Figure 8.18, an orifice will initially act as a weir until the top of the orifice is submerged. The discharge through the orifice for unsubmerged orifice

flow is computed using the weir equation. The flow then transitions to a fully submerged orifice flow. The flow through a fully submerged orifice is computed as:

$$Q = CA\sqrt{2gh}$$

where:

- Q = flow rate
- C = discharge coefficient
- A = orifice area
- g = acceleration of gravity
- h = head difference across the orifice

The area of an orifice's opening can be controlled dynamically through user-defined control rules. This feature can be used to model rule-based controlled gate openings and closings. See the section titled *Control Rules* on page 442 for more information.

The principal input parameters for an orifice include:

- Inlet and outlet nodes
- Configuration (bottom or side)
- Orifice shape (circular or rectangular)
- Height above the inlet node invert
- Discharge coefficient
- Time to open or close (optional)

The Orifices dialog box, as shown in the following figure, is displayed when an existing orifice is selected for editing by double-clicking it in the Plan View using the **SELECT ELEMENT** tool. Also, you can choose **INPUT > ORIFICES** or double-click the **ORIFICES** icon from the data tree to display the Orifices dialog box.

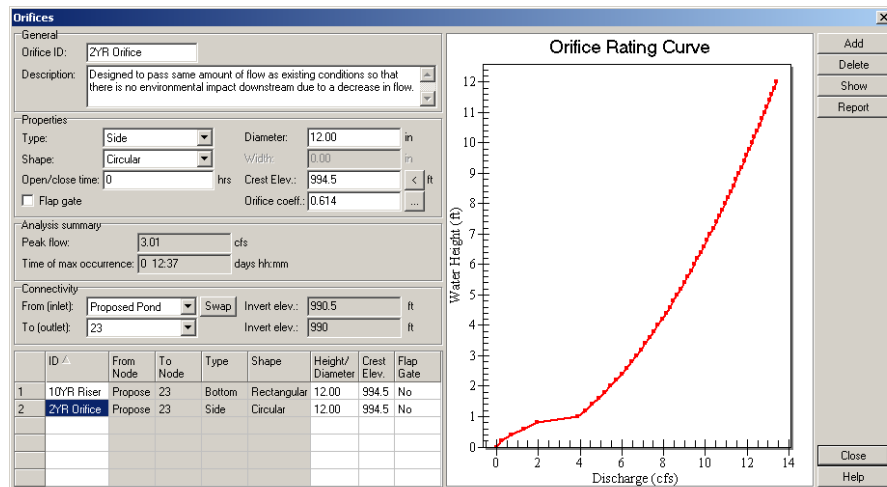



Figure 8.19 The Orifices dialog box

To select an orifice, scroll through the displayed table and click the row containing the orifice of interest. The provided data entry fields will then display information describing the selected orifice. In addition, a rating curve graphical plot of water height above inlet invert elevation versus discharge is displayed, showing the hydraulic discharge capacity of the selected orifice. This graphical plot can be

printed or exported, if desired. Right-click the graph and a context menu will be displayed, allowing you to print or export the graphic, as well as adjust the graphical plot.

To add a new orifice, it is recommended that the orifice be added interactively on the Plan View using the **ADD ORIFICE**  tool. However, a new orifice can be manually added by clicking the Add button and then entering the appropriate information in the provided data entry fields. To delete an existing orifice, select the orifice from the table and then click the Delete button. Click the Show button to zoom to a region around the currently selected orifice in the Plan View, and then highlight the orifice. Click the Report button to generate a Microsoft Excel report detailing all currently defined orifice input data and any corresponding analysis results.

The following data are used to define an orifice:

Orifice ID

Enter the unique name (or ID) that is to be assigned to the orifice being defined. This name can be alphanumeric (i.e., contain both numbers and letters), can contain spaces, is case insensitive (e.g., $ABC = abc$), and can be up to 128 characters in length. Therefore, the assigned name can be very descriptive, to assist you in identifying different orifices.

A new orifice ID is automatically defined by the software when a new orifice is added. However, the orifice ID can be changed within this field.

When importing (or merging) multiple stormwater or sanitary sewer network models into a single model, the software will check for collisions between identical orifice IDs and can automatically assign a new orifice ID for any orifices being imported that contain the same orifice ID as already exist in the network model. See the section titled *Merging Network Models* on page 494 for more information.

Description (optional)

Enter an optional description that describes the orifice being defined.

Type

This drop-down list allows you to select the type of orifice being defined. The following orifice types are supported:

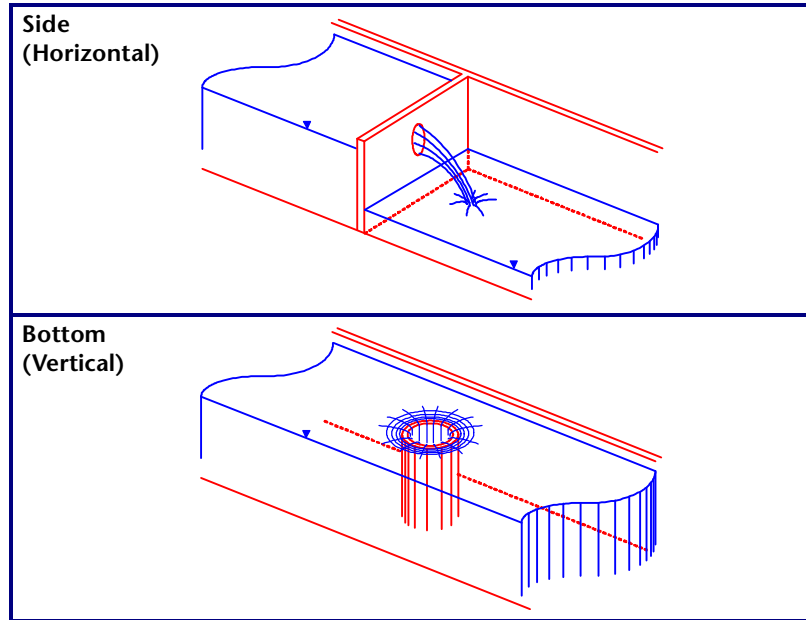
**Shape**

This drop-down list allows you to select the shape of orifice being defined. The following orifice shapes are available:

- Circular
- Rectangular

Open/Close Time (optional)

This entry is used to simulate the real-time operation of a gate opening and closing. This entry defines the time it takes to open a closed (or close an opened) gated orifice in decimal hours. Enter 0 or leave blank if timed openings/closings do not apply. Control rules are used to adjust the gate open/closed position, and are described in detail on page 442.

Flap Gate

This check box is used to denote whether a flap gate exists to prevent backflow through the orifice. By default, no flap gate is defined.

Height (or Diameter)

Height of a rectangular orifice or diameter of a circular orifice when fully opened (ft or m).

Width

Width of a rectangular orifice when fully opened (ft or m). This entry is grayed out (i.e., not available) when defining a circular orifice.

Crest Elevation (or Crest Height)

Elevation of the orifice crest bottom (or height of the orifice crest bottom above the inlet node invert) in ft or m. Clicking the  button will cause the orifice crest bottom elevation to be set equal to the inlet node invert elevation.

Discharge Coefficient

Orifice discharge coefficient (unitless) for defined orifice. A typical value for a circular orifice is 0.614. Clicking the (...) browse button will display the Orifice Coefficients reference dialog box, as shown in the following figure, which lists typical orifice discharge coefficients based upon orifice shape.

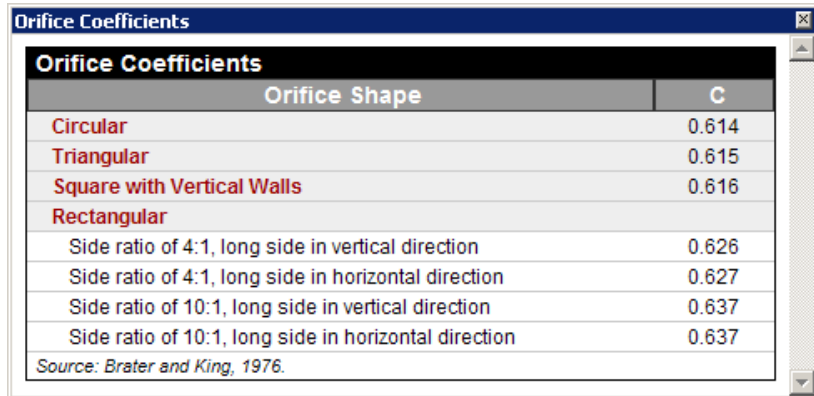

Orifice Shape	C
Circular	0.614
Triangular	0.615
Square with Vertical Walls	0.616
Rectangular	
Side ratio of 4:1, long side in vertical direction	0.626
Side ratio of 4:1, long side in horizontal direction	0.627
Side ratio of 10:1, long side in vertical direction	0.637
Side ratio of 10:1, long side in horizontal direction	0.637

Source: Brater and King, 1976.

Figure 8.20 The Orifices Coefficients reference dialog box

From (Inlet)

Node ID on the inlet (upstream) side of the orifice. Clicking the Swap button will switch the inlet and outlet nodes.

To (Outlet)

Node ID on the outlet (downstream) side of the orifice. Clicking the Swap button will switch the inlet and outlet nodes.

Analysis Summary Section

The Orifices dialog box provides a section titled **ANALYSIS SUMMARY** that provides a brief summary of the simulation results for the selected orifice, as shown in the following figure.

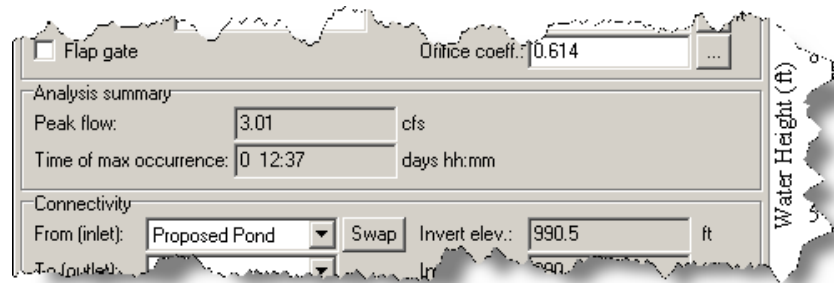

Figure 8.21 The Analysis Summary section of the Orifices dialog box

A description of the available analysis result fields is provided below:

Peak Flow

This analysis output field provides the peak flow rate that occurred at the orifice during the simulation period.

Time of Max Occurrence

This analysis output field provides the date and time that the peak flow rate occurred at the orifice during the simulation period.

Controllable Gates and Valves

An orifice's opening height can be controlled dynamically through user-defined control rules. This feature can be used to simulate real-time operation of gate and valve openings and closings. Control rules are described in detail on page 442.

Complex Discharge Structures

If you are needing to define a more complex discharge structure than can be represented using an orifice element, then use an outlet element. An outlet can define discharge using a head versus discharge rating curve, thereby allowing any type of discharge relationship to be defined. Outlet structures are described in detail in the next section.

Flow Reversals



If the orifice you are defining will experience a flow reversal as part of its normal operation, you may need to redefine the orifice as a pipe. The orifice equation is not meant to be run in a flow reversal fashion, and may cause some strange behavior in the model results.

Outlets

Outlets are flow control devices that are typically used to control outflows from storage nodes (e.g., detention ponds). They are used to model special head versus discharge relationships that cannot be characterized by pumps, orifices, or weirs.

For example, perhaps you are needing to design a detention pond outlet structure that meets stormwater regulations requiring specific discharges for different design storms. Designing the outlet structure might be too complex to be defined by simple orifice and weir structures, and might lend itself to an iterative design using a spreadsheet. Once the structure has been designed, the head versus discharge rating curve can be defined within the software using an outlet.

Outlets attached to storage nodes are active under all types of flow routing. If not attached to a storage node, they can only be used in drainage networks analyzed with Hydrodynamic Routing.



Outlets are internally represented as a link connecting two nodes. An outlet can also have a flap gate that restricts flow to only one direction.

A user-defined function or rating curve table can be used to define the outlet's discharge. The outlet's discharge can be referenced using either the freeboard depth above the outlet's opening or the head difference across the outlet structure.

Control Rules can be used to dynamically adjust this flow when certain conditions exist. See the section titled *Control Rules* on page 442 for more information.

The principal input parameters for an outlet include:

- Inlet and outlet nodes
- Height above the inlet node invert
- Function or table containing its head-discharge relationship

The Outlets dialog box, as shown in the following figure, is displayed when an existing outlet is selected for editing by double-clicking it in the Plan View using the **SELECT ELEMENT**  tool. Also, you can choose **INPUT > OUTLETS** or double-click the **OUTLETS**  icon from the data tree to display the Outlets dialog box.

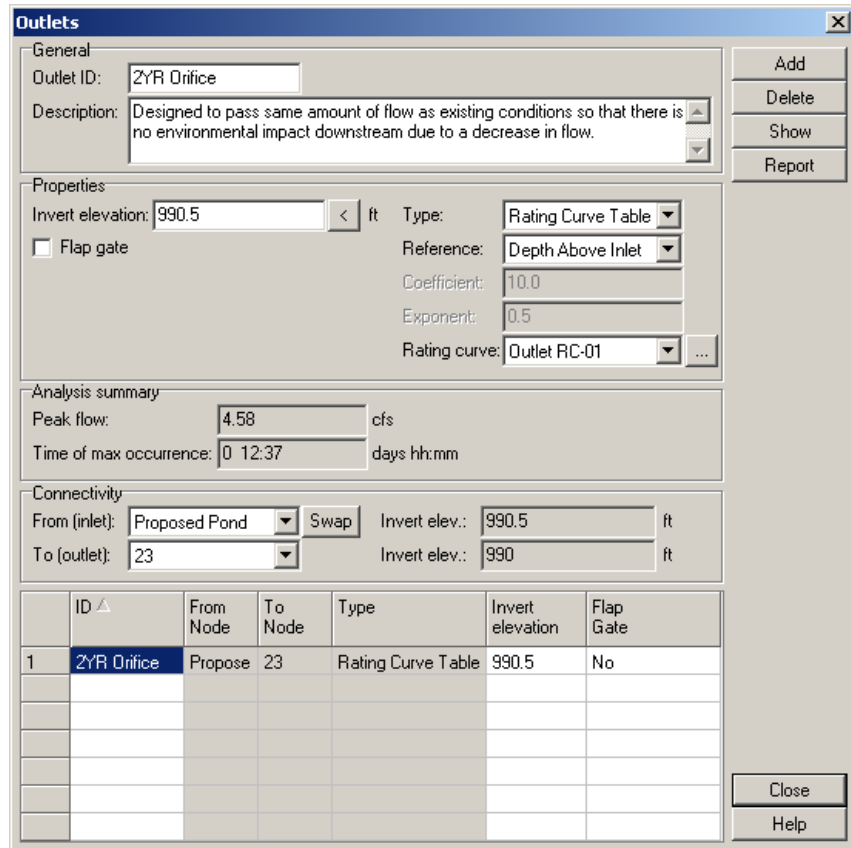



Figure 8.22 The Outlets dialog box

To select an outlet, scroll through the displayed table and click the row containing the outlet of interest. The provided data entry fields will then display information describing the selected outlet.

To add a new outlet, it is recommended that the outlet be added interactively on the Plan View using the **ADD OUTLET**  tool. However, a new outlet can be manually added by clicking the Add button and then entering the appropriate information in the provided data entry fields. To delete an existing outlet, select the outlet from the table and then click the Delete button. Click the Show button to zoom to a region around the currently selected outlet in the Plan View, and then highlight the outlet. Click the Report button to generate a Microsoft Excel report detailing all currently defined outlet input data and any corresponding analysis results.

The following data are used to define an outlet:

Outlet ID

Enter the unique name (or ID) that is to be assigned to the outlet being defined. This name can be alphanumeric (i.e., contain both numbers and letters), can contain spaces, is case insensitive (e.g., ABC = abc), and can be up to 128 characters in length. Therefore, the assigned name can be very descriptive, to assist you in identifying different outlets.

A new outlet ID is automatically defined by the software when a new outlet is added. However, the outlet ID can be changed within this field.

When importing (or merging) multiple stormwater or sanitary sewer network models into a single model, the software will check for collisions between identical outlet IDs and can automatically assign a new outlet ID for any outlets being imported that contain the same outlet ID as already exist in the network model. See the section titled *Merging Network Models* on page 494 for more information.

Description (optional)

Enter an optional description that describes the outlet being defined.

Invert Elevation (or Height)

Elevation of the outlet bottom (or height of the outlet bottom above the inlet node invert) in ft or m. Clicking the  button will cause the outlet bottom elevation to be set equal to the inlet node invert elevation.

Flap Gate

This check box is used to denote whether a flap gate exists to prevent backflow through the outlet. By default, no flap gate is defined.

Type

A user-defined function or rating curve table can be used to define the outlet's discharge. This drop-down list allows you to select the type of outlet structure to be defined:

Rating Curve Table This option specifies that the outlet discharge will be defined by a rating curve table. This option is commonly used to define the outlet discharge for a detention pond.

From the Rating Curve drop-down list, select the outlet rating curve that contains the tabular data can be referenced using either the freeboard depth above the outlet's opening or the head difference across the outlet structure.

Click the  button to display the Outlet Rating Curves dialog box, described in the next section, to define a new rating curve.

Discharge Function This option specifies that the outlet discharge will be defined by a discharge function.

Specify the coefficient (A) and exponent (B) that describes the functional relationship between freeboard depth above the outlet's opening (or the head difference across the outlet structure) and flow rate based upon the following expression:

$$Head = A * Discharge^B$$

Note that this method can be used to define a constant flow rate (i.e., throttle valve) discharge structure. For these discharge structures, only the Coefficient entry is specified—corresponding to the maximum flow rate in cfs or cms. The exponent B value then needs to remain blank (or entered as 0).

Reference

The outlet's discharge can be referenced using either the freeboard depth above the outlet's opening or the head difference across the outlet structure. This drop-down list allows you to select the type of reference to be used:

Depth Above Inlet	This option defines the discharge relationship based upon the depth of water above the outlet's opening at the inlet node. Note that this option cannot account for tailwater backwater effects.
Head Differential	This option defines the discharge relationship based upon the difference in head across the outlet's inlet and outlet nodes. Note that this option can account for tailwater backwater effects.

Coefficient

This is the coefficient, A , listed in the functional discharge expression described above.

Note that this entry can be used to define a constant flow rate (i.e., throttle valve) discharge structure, such as vortex-type throttle valve. For example, if a vortex-type throttle valve is rated at a maximum flow of 5 cfs, then 5 should be entered in this field and the exponent B value should remain blank (or entered as 0).

Exponent

This is the exponent, B , listed in the functional discharge expression described above.

Rating Curve

This drop-down list allows you to select an already defined rating curve that contains the tabular data of head versus outflow (cfs or cms) for the outlet structure. Click the browse button to display the Outlet Rating Curves dialog box, described in the next section, to define a new rating curve.

From (Inlet)

Node ID on the inlet (upstream) side of the outlet. Clicking the Swap button will switch the inlet and outlet nodes.

To (Outlet)

Node ID on the outlet (downstream) side of the outlet. Clicking the Swap button will switch the inlet and outlet nodes.

Analysis Summary Section

The Orifices dialog box provides a section titled **ANALYSIS SUMMARY** that provides a brief summary of the simulation results for the selected outlet, as shown in the following figure.



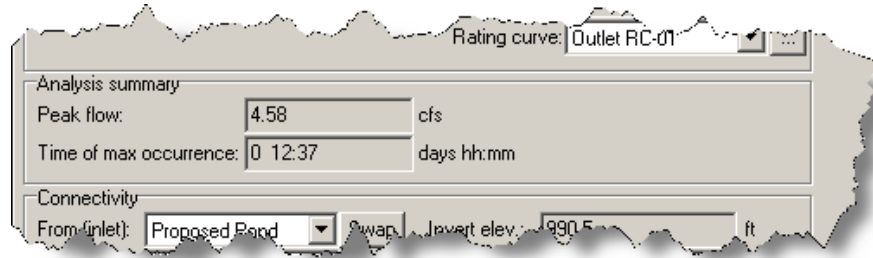

Figure 8.23 The Analysis Summary section of the Outlets dialog box

A description of the available analysis result fields is provided below:

Peak Flow

This analysis output field provides the peak flow rate that occurred at the outlet during the simulation period.

Time of Max Occurrence

This analysis output field provides the date and time that the peak flow rate occurred at the outlet during the simulation period.

Tailwater Submergence Effects



Unlike orifice and weir elements, outlet elements cannot directly account for tailwater submergence effects. However, if the head differential option is used, then the discharge relationship is based upon the difference in head across the outlet’s inlet and outlet nodes and can account for tailwater backwater.

Therefore, if tailwater submergence effects are likely to be dominate effect at an outflow structure, outlet elements should not be used to define the structure.

Controllable Outlets

Control Rules can be used to dynamically adjust the outlet flow when certain conditions exist. This feature can be used to simulate real-time operation of a gate, and other hydraulic control structures. Control rules are described in detail on page 442.

Vortex Flow Control Devices

For new site developments, flow controls and an underground or surface storage structure are typically used to limit stormwater discharge rates to no more than pre-development runoff rates. In designing such a detention structure, the discharge from the structure must be restricted to particular flow rates for different size storms.

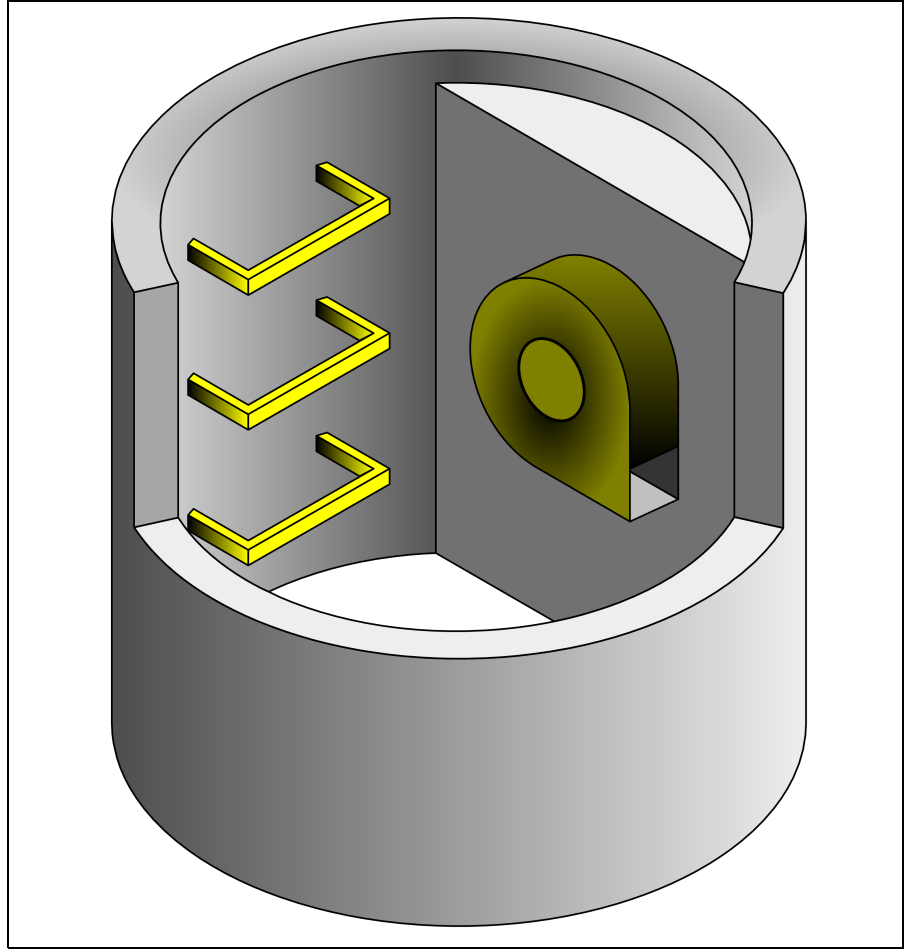

Figure 8.24 Cutaway of a manhole showing a typical vortex flow control device

A vortex flow control device has an advantage over a standard orifice plate, since it tends to throttle the peak flow to a maximum flow rate for a range of different head values. As shown in the following figure, this allows some reduction in the total required storage volume necessary for the detention structure since a constant outflow is discharged from a structure. An outlet structure can be used to represent a vortex flow control device, by defining an outlet rating curve that matches the head vs. discharge curve for the vortex device.

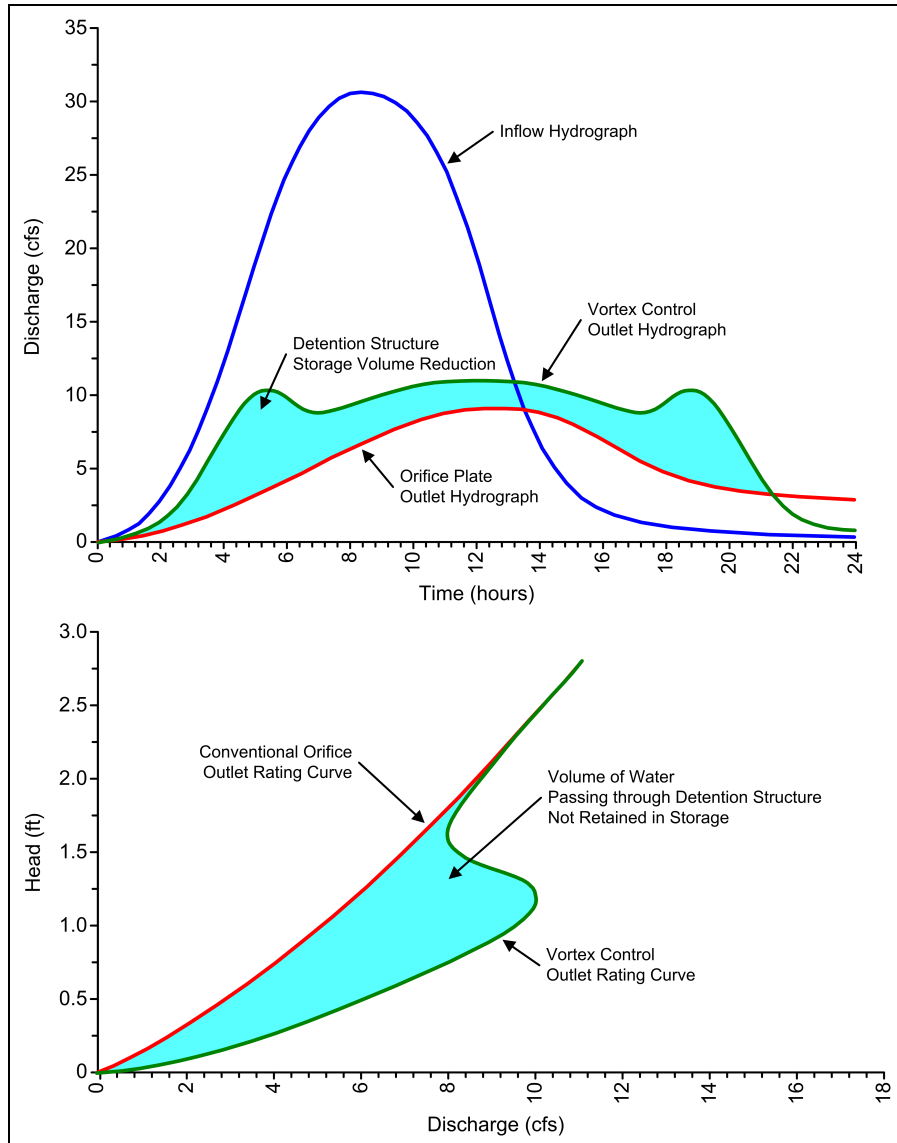



Figure 8.25 Comparison of conventional orifice and vortex flow control device

Outlet Rating Curves

The Outlet Rating Curves dialog box, as shown in the following figure, is displayed when a new outlet rating curve is created or an existing outlet rating curve is selected for editing. This curve relates freeboard depth above the outlet's opening (or the head difference across the outlet structure) and flow rate.

Select **INPUT** ► **OUTLET RATING CURVES** or double-click the **OUTLET RATING CURVES**  icon from the data tree to display the Outlet Rating Curves dialog box. This dialog box can also be displayed by clicking the  browse button from the **RATING CURVE** data field in the Outlets dialog box (see page 301) when defining an outlet structure.

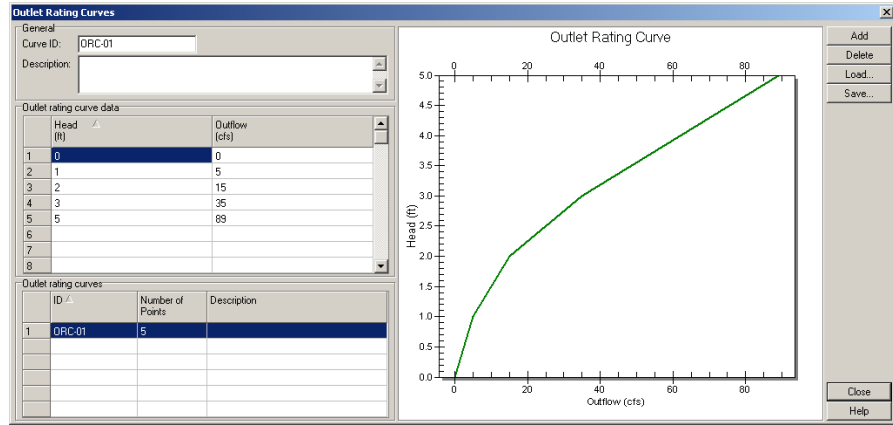

Figure 8.26 The Outlet Rating Curves dialog box

To select an existing outlet rating curve, scroll through the outlet rating curve table and click the row containing the outlet rating curve of interest. The provided data definition table will then display the head versus outflow data describing the selected outlet rating curve. In addition, a rating curve graphical plot of water freeboard depth above the outlet's opening (or the head difference across the outlet structure) versus discharge is displayed, showing the hydraulic discharge capacity of the selected outlet. This graphical plot can be printed or exported, if desired. Right-click the graph and a context menu will be displayed, allowing you to print or export the graphic, as well as adjust the graphical plot.

To add a new outlet rating curve, click the Add button and then enter the curve data in the data definition table. To delete an outlet rating curve, select the outlet rating curve from the outlet rating curve table and then click the Delete button.

The following data are used to define an outlet rating curve:

Rating Curve ID

Enter the unique name (or ID) that is to be assigned to the rating curve being defined. This name can be alphanumeric (i.e., contain both numbers and letters), can contain spaces, is case insensitive (e.g., *ABC = abc*), and can be up to 128 characters in length. Therefore, the assigned name can be very descriptive, to assist you in identifying different rating curves.

Description (optional)

Enter an optional comment or description of the rating curve.

Depth / Head

Enter the rating curve's freeboard depth (ft or m) above the outlet's opening (or the head difference across the outlet structure) data.

Head / Outflow

Enter the rating curve's corresponding outflow (cfs or cms) curve data.

Right-Click Context Menu

Right-click the data table to display a context menu. This menu contains commands to cut, copy, insert, and paste selected cells in the table as well as options to insert or delete rows. The table values can be highlighted and copied to the clipboard for pasting into Microsoft Excel. Similarly, Excel data can be pasted into the table of head versus outflow.

Importing and Exporting Outlet Rating Curve Data

Click the Load button to import an outlet rating curve that was previously saved to an external file or click the Save button to export the current outlet rating curve data to an external file.

Unit Conversion Problems



Note that changing the flow units of an existing network model (even within the same unit system, i.e., metric) can create conversion problems. This is due to the change in the units used to define outlet rating curves. For example, changing the flow units from CMS to LPS in the Project Options dialog box (see page 163), will cause the outlet rating curve input data requirements change from CMS to LPS. However, previously entered input data in CMS units will not automatically convert to LPS units. Therefore, the hydraulic response of any previously defined outlet structures will change due to the flow unit change, and will make this change difficult to pinpoint in troubleshooting the model.

Spillways and Weirs

Spillways and weirs, like orifices, are used to model outlet and diversion structures in a drainage system. Weirs are typically located in a manhole, along the side of a channel, or at the outlet for a storage node (e.g., detention pond). They are internally represented as a link connecting two nodes, where the weir itself is placed at the upstream node. A flap gate can be included to prevent backflow.

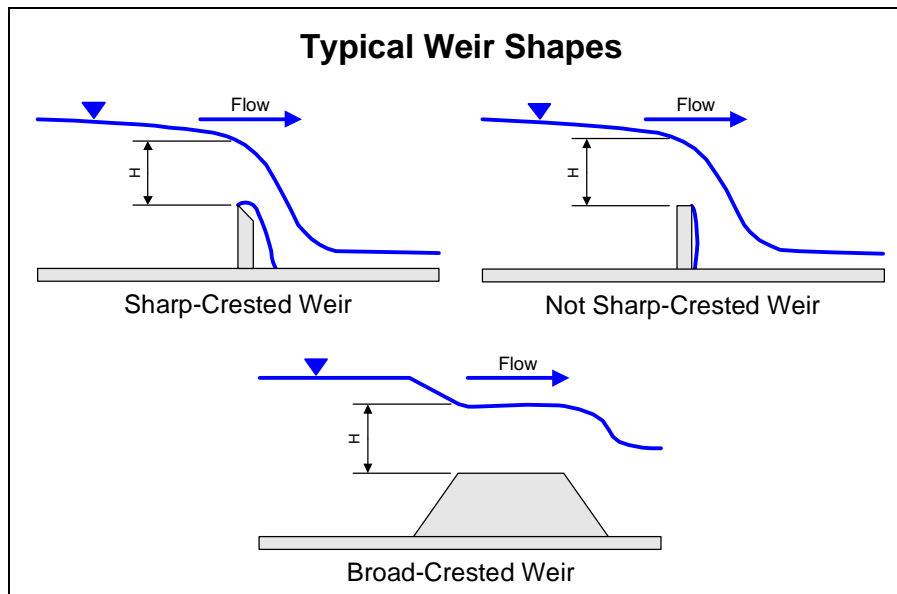

Figure 8.27 Weir types (Source: US DOT Federal Highway Administration, August 2001, Hydraulic Design Series No. 4, Introduction to Highway Design)

A weir is typically a notch of regular shape (rectangular, square, or triangular), with a free surface. The edge or surface over which the water flows is called the crest. As shown in Figure 8.27, a weir with a crest where the water springs free of the crest at the upstream side is called a *sharp-crested weir*. If the water flowing over the weir does not spring free and the crest length is short, the weir is called a *not sharp-crested weir*, *round edge weir*, or *suppressed weir*. If the weir has a horizontal or sloping crest sufficiently long in the direction of flow that the flow pressure distribution is hydrostatic, it is called a *broad crested weir*. As with orifices, weirs can be used to

measure water flow. If a sharp crested weir is to be used for measurement purposes, then the weir flow must be aerated on the downstream side and the pressure on the nape downstream be atmospheric.

Four different types of weirs are available in the software, each incorporating a different formula for computing weir flow, as listed in Table 8.1. These different weirs also include the effect of flow having to change direction, such as a transverse and side flow weir. Weir flow computed by the software can account for tailwater submergence effects.

Table 8.1 Available weir types, cross section shapes, and corresponding weir flow equation

Weir Type	Shape	Flow Formula
Transverse	Rectangular	$C_w L h^{3/2}$
Side Flow	Rectangular	$C_w L h^{5/3}$
V-Notch	Triangular	$C_w S h^{5/2}$
Trapezoidal	Trapezoidal	$C_w L h^{3/2} + C_{ws} S h^{5/2}$

C_w = weir discharge coefficient

L = weir length

S = side slope of V-notch or trapezoidal weir

h = head difference across the weir



C_{ws} = discharge coefficient through sides of trapezoidal weir

The principal input parameters for a weir definition include:

- Inlet and outlet nodes
- Shape and geometry
- Crest height above the inlet node invert
- Discharge coefficient

Weirs can be used as storage node outlets under all types of flow routing. If not attached to a storage node, they can only be used in drainage networks that are analyzed with Hydrodynamic Routing.

The height of the weir crest above the inlet node invert can be controlled dynamically through user-defined control rules. This feature can be used to model inflatable dams. See the section titled *Control Rules* on page 442 for more information.

The Weirs dialog box, as shown in the following figure, is displayed when an existing weir is selected for editing by double-clicking it in the Plan View using the **SELECT ELEMENT**  tool. Also, you can choose **INPUT**  **WEIRS** or double-click the **WEIRS**  icon from the data tree to display the Weirs dialog box.

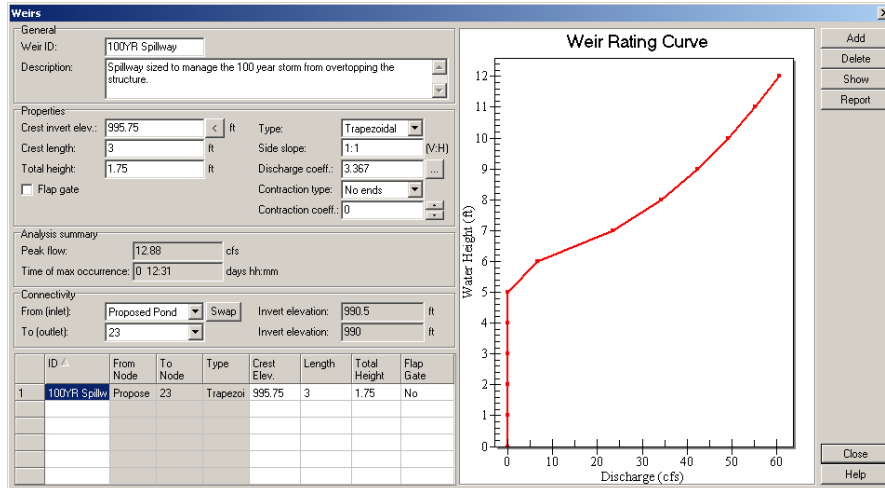



Figure 8.28 The Weirs dialog box

To select a weir, scroll through the displayed table and click the row containing the weir of interest. The provided data entry fields will then display information describing the selected weir. In addition, a rating curve graphical plot of water height above weir crest versus discharge is displayed, showing the hydraulic discharge capacity of the selected weir. This graphical plot can be printed or exported, if desired. Right-click the graph and a context menu will be displayed, allowing you to print or export the graphic, as well as adjust the graphical plot.

To add a new weir, it is recommended that the weir be added interactively on the Plan View using the **ADD WEIR**  tool. However, a new weir can be manually added by clicking the Add button and then entering the appropriate information in the provided data entry fields. To delete an existing weir, select the weir from the table and then click the Delete button. Click the Show button to zoom to a region around the currently selected weir in the Plan View, and then highlight the weir. Click the Report button to generate a Microsoft Excel report detailing all currently defined weir input data and any corresponding analysis results.

The following data are used to define a weir:

Weir ID

Enter the unique name (or ID) that is to be assigned to the weir structure being defined. This name can be alphanumeric (i.e., contain both numbers and letters), can contain spaces, is case insensitive (e.g., *ABC = abc*), and can be up to 128 characters in length. Therefore, the assigned name can be very descriptive, to assist you in identifying different weir structures.

A new weir ID is automatically defined by the software when a new weir is added. However, the weir ID can be changed within this field.

When importing (or merging) multiple stormwater or sanitary sewer network models into a single model, the software will check for collisions between identical weir IDs and can automatically assign a new weir ID for any weirs being imported that contain the same weir ID as already exist in the network model. See the section titled *Merging Network Models* on page 494 for more information.

Description (optional)

Enter an optional description that describes the weir structure being defined.

Crest Invert Elevation (or Crest Invert Offset)

Elevation of the weir crest (or height of the weir crest bottom above the inlet node invert) in ft or m. Clicking the  button will cause the weir crest elevation to be set equal to the inlet node invert elevation.

The weir crest elevation (or height) can also be controlled dynamically through user-defined control rules. This feature can be used to model inflatable weirs and rubber dams. See the section titled *Control Rules* on page 442 for more information.

Crest Length

Horizontal crest length of the weir opening (except for v-notch weirs), measured perpendicular to the direction flow (ft or m). Note that this field is only displayed when a v-notched weir is not selected.

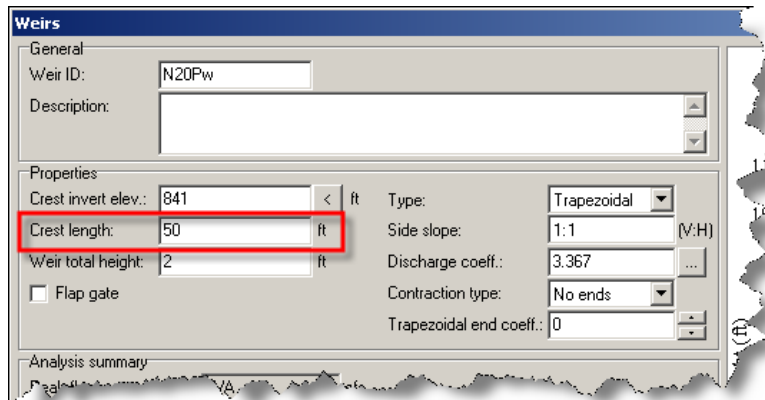

Figure 8.29 The Crest Length entry is typically provided, except for v-notched weirs

Crown Length

Horizontal length of the v-notch weir opening at the top of the weir, measured perpendicular to the direction flow (ft or m). Note that this field is only displayed when a v-notched weir is selected.

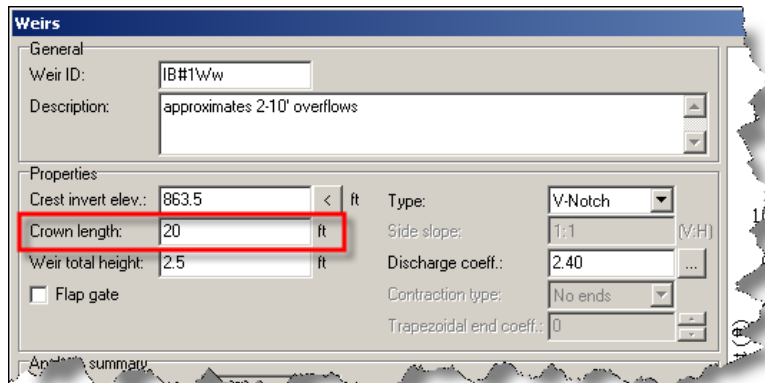

Figure 8.30 The Crown Length entry is only available for v-notched weirs

Weir Total Height

Vertical height of the weir opening above the weir crest (ft or m).

Note that this vertical height should be sufficiently high for any flow going over the weir crest, in order for the weir flow to maintain a free surface. If not, then the weir will essentially begin to function as a weir and sluice gate,

essentially restricting the amount of flow through the weir when the upstream water surface elevation exceeds this value. Flow through the structure will then be computed using the orifice equation.

Flap Gate

This check box is used to denote whether a flap gate exists to prevent backflow through the weir structure. By default, no flap gate is defined.

Type

Five different types of weirs are available, each incorporating a different formula for computing flow across the weir. This drop-down list allows you to select the type of weir structure being defined. The following types of weir structures are supported:

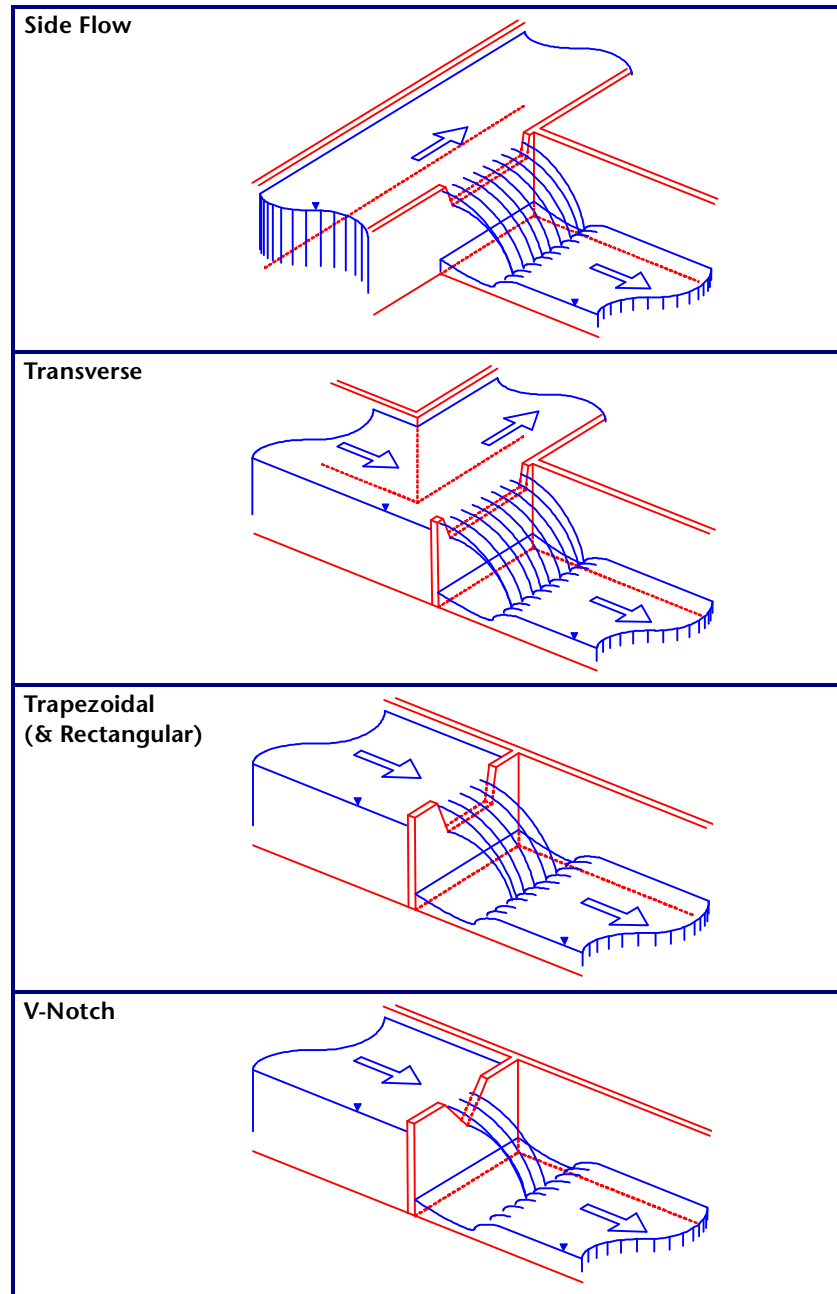

Side Slope

Slope (width to height) of the side walls for trapezoidal weirs. When modeling trapezoidal weirs with vertical sides, either enter a value of 1:0 or select a rectangular weir. Note that for v-notch weirs, the **CROWN LENGTH** entry is used to define the size of the v-notch.

Discharge Coefficient

Weir discharge coefficient for flow through the central portion of the weir (cfs or cms).

Clicking the browse button will display the Weir Discharge Coefficients reference dialog box, as shown in the following figure, which lists typical weir discharge coefficients based upon weir shape.

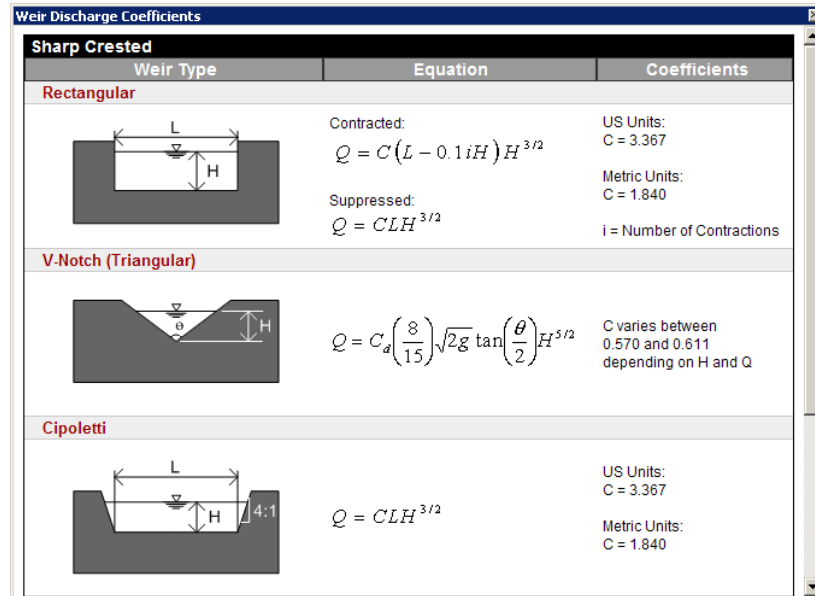

Figure 8.31 The Weir Discharge Coefficients reference dialog box

Contraction Type

This drop-down list denotes the number of end contractions for a transverse or trapezoidal weir whose length is shorter than the channel it is placed in. Available options are **NO ENDS**, **ONE END**, and **BOTH ENDS** depending upon how the weir contracts the flow on the upstream side of the weir.

As shown in the following figure, when the distances from the sides of the weir notch to the sides of the upstream weir pool are greater than two measurement heads, the water will flow relatively slowly along the bulkhead face toward the overflow opening. As the water from the sides of the channel nears the notch, it accelerates and has to turn to pass through the opening. This turning cannot occur instantaneously, so a curved flow path or side contraction results in which the water springs free to form a jet narrower than the overflow opening width. This effect is known as an end contraction. The more contraction of flow that occurs, the greater the head loss will be due to the weir.

The discharge equation from a sharp-crested rectangular weir with end contractions is shown in Figure 8.31. An examination of that equation shows that it is possible, under certain conditions, to calculate a negative discharge for an end contracted weir. This occurs when the head over the weir crest is large when compared to the weir length. The result is a negative effective weir length. Although this situation rarely occurs, the software will not calculate a negative effective weir length or negative discharges and will therefore set the effective weir flow length equal to 0.

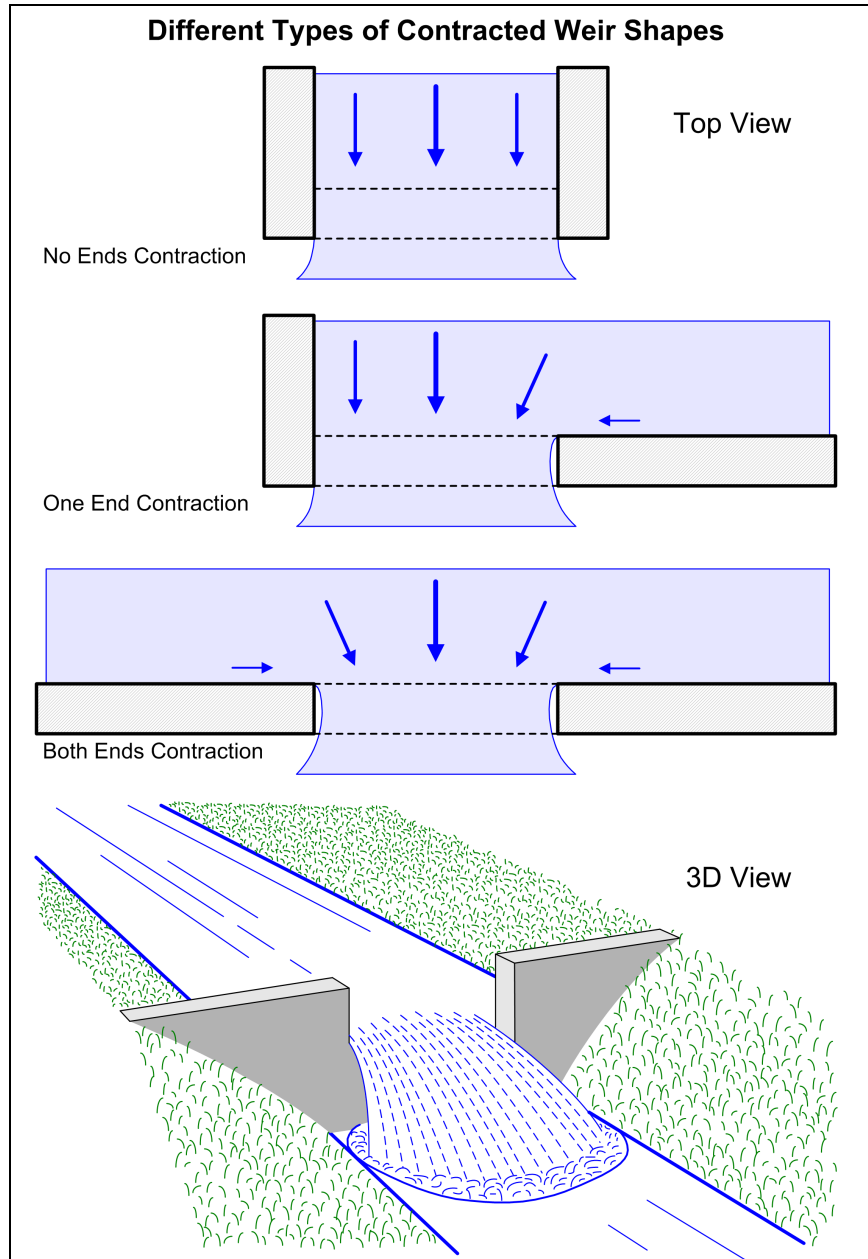

Figure 8.32 Different types of contracted weir shapes, where weir contractions are defined based upon if part of the flow is obstructed on one side, both sides, or no sides

Trapezoidal End Coefficient

This value represents the discharge coefficient for flow through the triangular ends of a trapezoidal weir. Typical values range from 2.4 to 2.8 for US units, and 1.35 to 1.55 for SI metric units. Note that this data entry field will be grayed out (e.g., unavailable) when defining other weir types other than a trapezoidal weir.

The weir flow equation for a trapezoidal weir is the combination of the rectangular and v-notch weir equations (see the Weir Discharge Coefficients reference dialog box, as shown in Figure 8.31). This formulation requires two

discharge coefficients—a discharge coefficient for the rectangular, central portion of the weir notch and a discharge coefficient for the triangular, side portions of the weir notch.

From (Inlet)

Node ID on the inlet (upstream) side of the weir structure. Clicking the Swap button will switch the inlet and outlet nodes.

To (Outlet)

Node ID on the outlet (downstream) side of the weir structure. Clicking the Swap button will switch the inlet and outlet nodes.

Analysis Summary Section

The Weirs dialog box provides a section titled **ANALYSIS SUMMARY** that provides a brief summary of the simulation results for the selected weir, as shown in the following figure.

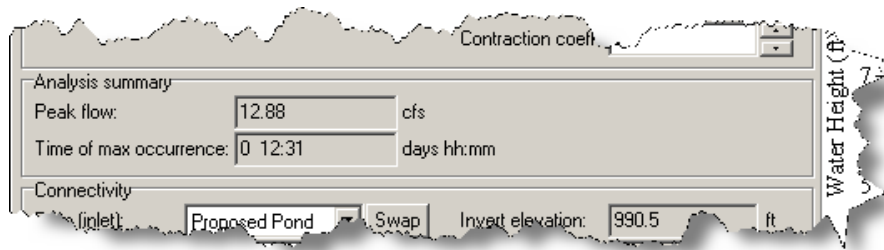

Figure 8.33 The Analysis Summary section of the Weirs dialog box

A description of the available analysis result fields is provided below:

Peak Flow

This analysis output field provides the peak flow rate that occurred at the weir during the simulation period.

Time of Max Occurrence

This analysis output field provides the date and time that the peak flow rate occurred at the weir during the simulation period.

Submerged Weir Flow

When the weir is highly submerged due to high tailwater conditions, the flow over the weir structure no longer acts like weir flow and the carrying capacity is reduced. In this situation, the analysis automatically switches to the Villemonte equation for submerged weirs.

Roadway Overflow Routing

For modeling overflow across a roadway, from either a culvert-bridge roadway crossing or a storm drain inlet overflow, a weir element can connect the upstream side of the roadway with the downstream side for routing the overflow. The weir crest elevation should be defined to match that of the roadway crown.

For example, for a culvert-bridge roadway crossing, a storage node is defined at the upstream side of the roadway to define the storage effects of the backwater upstream of the bridge-culvert. Then, a pipe link element is used to define the conveyance link of the culvert-bridge to a junction node at the downstream side of the roadway. In addition, a weir link element is defined to route overflow over

the roadway crown from the upstream storage node to the downstream junction node.

Similarly, a weir link element can be defined to model the roadway overflow from an on-sag storm drain inlet located on the upstream side of the roadway to a junction or another storm drain inlet at the downstream side of the roadway. If the water level for the overflow route at the downstream node is greater than the weir crest level, the weir discharge will be reduced using the submerged weir equation.

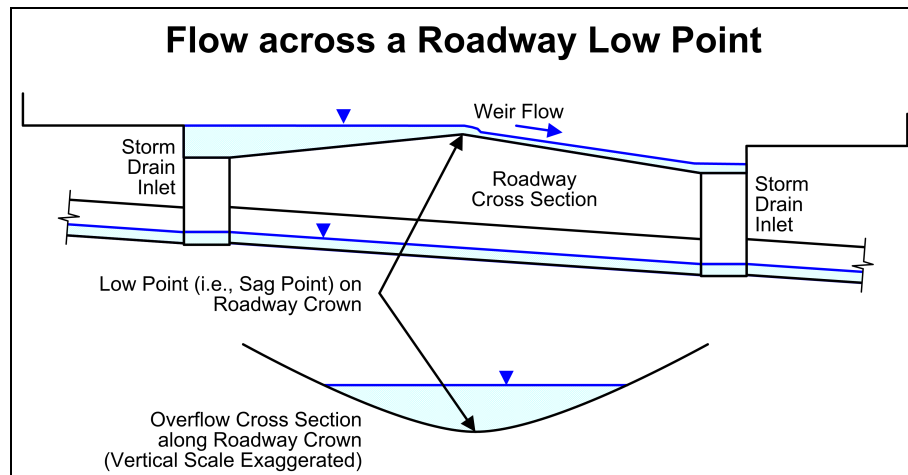

Figure 8.34 Roadway overflow routing

Controllable Inflatable Weirs and Rubber Dams

An inflatable weir (sometimes called a rubber dam) is used to control the amount of flow over a spillway by quickly adjusting the spillway crest elevation. These structures inflate and deflate rapidly with virtually no maintenance, and allow sophisticated control of stormwater discharge from a storage structure. A spillway crest elevation can be controlled dynamically through user-defined control rules. This feature can be used to simulate real-time operation of an inflatable weir. Control rules are described in detail on page 442.

Composite Weir Structures

To represent a composite weir structure, break the weir into its component parts as shown in the following figure. When defining each component weir section, make certain not to stack the weir sections vertically on top of each other. Each component weir section should have its own free surface. Then, define each component weir as an individual link from the storage node (i.e., detention pond) to the downstream node.

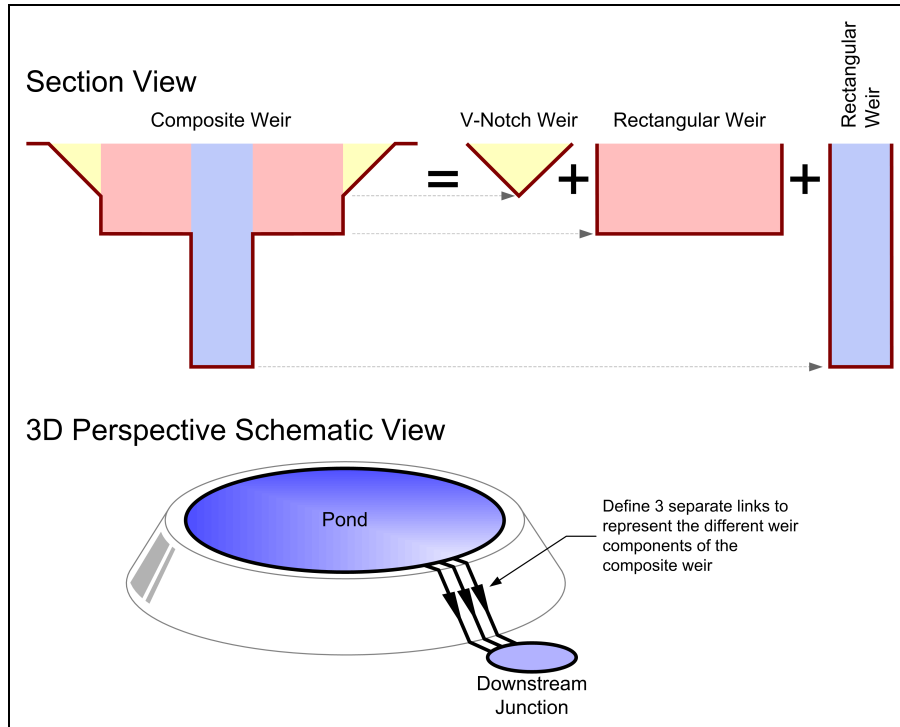

Figure 8.35 Composite weir definition

Complex Discharge Structures

If you are needing to define a more complex discharge structure than can be represented using a weir structure, then use an outlet element. An outlet can define discharge using a head versus discharge rating curve, thereby allowing any type of discharge relationship to be defined. Outlet structures are described in detail on page 298.

Subbasin Element Data

9

This chapter describes drainage subbasin (i.e., catchment or watershed) related data used to define a stormwater model.

Subbasins

Subbasins are hydrologic drainage subareas whose topography and drainage system elements direct surface runoff to a single discharge point. You are responsible for dividing a study area into an appropriate number of subbasins, and for identifying the outlet point of each subbasin. Discharge outlet points can be either nodes of the drainage system (or other subbasins if the EPA SWMM Hydrology Method is used).

Autodesk Storm and Sanitary Analysis supports a variety of hydrology methods that allow you to select the appropriate method to be used for the area being studied. For example, if performing a stormwater analysis of a small parking lot, the Rational Method is generally the most applicable since it is meant to model the peak runoff that would be expected from the site. However, if designing the drainage system for a site development, then it may be more appropriate to use the NRCS (SCS) TR-20 or TR-55 method, since this can then account for a 24 hour storm and can include the effects of attenuation and storage in the routing of the stormwater through the sewer system. For large urban master planning stormwater studies, EPA SWMM might be most appropriate method since it was developed for large, complex urban drainage areas including the effects of water quality.

The following different hydrology methods are provided:

- DeKalb Rational Method
- EPA SWMM
- Modified Rational Method
- Rational Method
- Santa Barbara Unit Hydrograph Method
- SCS TR-20
- SCS TR-55
- US Army Corps HEC-1

The drop-down entry **HYDROLOGY METHOD** in the Project Options dialog box, General tab, described on page 166, allows you to select the hydrology method to use to model subbasin runoff. Note that changing the hydrology method mid-way through defining a model may require re-entering some values for the hydrology runoff parameters for each subbasin.

In addition to selecting the hydrology method, you will need to select the time of concentration (Tc) method for modeling the travel time for the subbasin runoff. As with hydrology methods, there are many ways of estimating time of concentration.



The following Tc methods are supported:

- Carter
- Eagleson
- FAA
- Harris County, TX
- Kinematic Wave (EPA SWMM only)
- Kirpich
- Papadakis-Kazan (Maricopa & Pima Counties, AZ)
- SCS TR-55
- User-defined

The drop-down entry **TIME OF CONCENTRATION (TOC) METHOD** in the Project Options dialog box, General tab, described on page 167, allows you to select the Tc method to use to model subbasin runoff travel time. Note that changing the Tc method mid-way through defining a model may require re-entering some values for the Tc parameters for each subbasin.

Subbasins Dialog Box

Due to the variety of different hydrology and time of concentration methods that are supported by the software, the Subbasins dialog box will change the tabs and input data fields that are displayed. As such, some of the provided screen captures may not exactly match what your version of the software displays. In addition, some data entry fields will be grayed out (e.g., unavailable) since they are not applicable for a particular method. To assist in this regard, additional sections have been provided (following this section) to discuss various aspects of the Subbasins dialog box based upon the hydrology and time of concentration methods selected.

The Subbasins dialog box, as shown in the following figure, is displayed when an existing subbasin is selected for editing by double-clicking it in the Plan View using the **SELECT ELEMENT**  tool. Also, you can choose **INPUT**  **SUBBASINS** or double-click the **SUBBASINS**  icon from the data tree to display the Subbasins dialog box.

Subbasins

General
Subbasin ID: 1

Connectivity
Rain gage: Design Storm
Outlet node: 9

Description:

Physical Properties | SCS TR-55 TOC | Curve Number

Physical properties
Area: 11.280 ac
Equivalent width: 600 ft
Average slope: 0.5 %
Time of concentration: 46.74 min
Weighted curve number: 74.00

Impervious area
Area: 0 %
No depression: 25 %
Manning's roughness: 0.015
Curve number: 98

Pervious area
Curve number: 76
Manning's roughness: 0.1

Analysis summary
Peak runoff: 7.700 cfs
Total precipitation: 3.300 in
Total runoff: 1.104 in

	Subbasin ID ▲	Area	Wt. CN	TOC	Rain Gage ID
1	1	11.280	74.00	46.74	Design Storm
2	2	8.970	79.00	46.89	Design Storm
3	3	5.280	74.00	41.92	Design Storm
4	4	3.960	74.00	41.92	Design Storm
5	5	14.100	74.00	48.20	Design Storm
6	6	9.670	84.80	42.65	Design Storm

Buttons: Delete, Show, Report, Close, Help

Figure 9.1 The Subbasins dialog box is used to define data for watershed subbasins

To select a subbasin, scroll through the displayed table and click the row containing the subbasin of interest. The provided data entry fields will then display information describing the selected subbasin.

A new subbasin is added interactively on the Plan View using the **ADD SUBBASIN**  tool. To delete an existing subbasin, select the subbasin from the table and then click the Delete button. Click the Show button to zoom to a region around the currently selected subbasin in the Plan View, and then highlight the subbasin. Click the Report button to generate a Microsoft Excel report detailing all currently defined subbasin input data and any corresponding analysis results.

The following data are used to define a subbasin:

Subbasin ID

Enter the unique name (or ID) that is to be assigned to the subbasin being defined. This name can be alphanumeric (i.e., contain both numbers and letters), can contain spaces, is case insensitive (e.g., *ABC = abc*), and can be up to 128 characters in length. Therefore, the assigned name can be very descriptive, to assist you in identifying different subbasins.

A new subbasin ID is automatically defined by the software when a new subbasin is added. However, the subbasin ID can be changed within this field.

When importing (or merging) multiple stormwater network models into a single model, the software will check for collisions between identical subbasin IDs and can automatically assign a new subbasin ID for any subbasins being imported that contain the same subbasin ID as already exist in the network model. See the section titled *Merging Network Models* on page 494 for more information.

Description (optional)

Enter an optional description that describes the subbasin being defined.

Rain Gage

This drop-down list allows you to select an already defined rain gage that is to be associated with the subbasin. The rain gage defines the rainfall precipitation and storm distribution to be applied to the subbasin. Click the  browse button to display the Rain Gages dialog box, as described on page 388, to define a new rain gage.

Note that you can globally assign a rain gage to all subbasins by right-clicking a rain gage from the Plan View and selecting **ASSIGN TO ALL SUBBASINS** from the displayed context menu. Alternatively, within the Rain Gages dialog box you can click the Assign button to assign all of the model's subbasins to a rain gage. This is described in the Rain Gages dialog box section on page 388.

Directly Assigning Storm Precipitation

Instead of defining a rain gage and assigning it to the subbasins in a model, you can directly assign the storm to be analyzed using the Analysis Options dialog box. See the section titled *Storm Selection* on page 76 for more information.

Rational Method, Modified Rational, DeKalb Rational Method

Note that when you are using the Rational Method, DeKalb Rational Method, or Modified Rational hydrology method, then a rain gage is not used to define the precipitation for the model. Instead, an Intensity Duration Frequency (IDF) distribution (or equivalent method) is used to specify the rainfall intensity and duration to be modeled. This is described in detail in the section titled *IDF Curves* on page 398.

Outlet Node

This drop-down list allows you to select the outlet node or subbasin that is to receive the runoff from the subbasin. Note that any node type (i.e., junction, outfall, storage node, and flow diversion) can be assigned as the outlet node for the subbasin. If the EPA SWMM Hydrology Method is used, then the subbasin outlet node can be another subbasin.

Note that you can easily assign the subbasin outlet node from the Plan View. Right-click the subbasin and select **CONNECT TO** from the displayed context menu. The software will then rubber-band a line from the subbasin centroid to the cursor. Click the outlet node (or another subbasin) to use for receiving runoff from the current subbasin.

Physical Properties Tab

To make the Subbasins dialog box easier to use, the dialog box has been broken into separate tabs. The Physical Properties tab, shown in the following figure, defines the physical data for subbasins. Note that some of the data entry fields provided in this section may be grayed out (or unavailable) since some data fields are applicable to only certain hydrology methods.

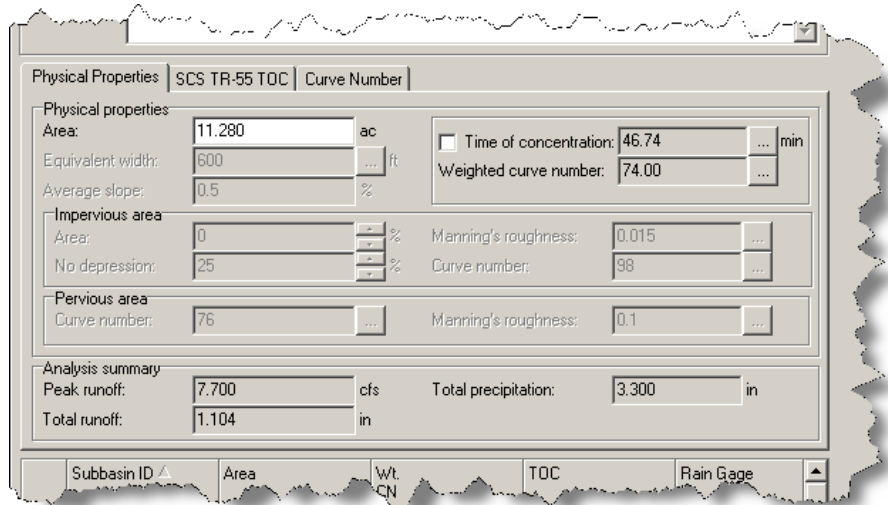

Figure 9.2 The Subbasins dialog box Physical Properties tab

Area

Specify the drainage area (acres/ft² or hectares/m²) for the subbasin being defined. Note that the drainage units (acres/ft² or hectares/m²) is defined by the entry **SUBBASIN AREA UNITS** in the Project Options dialog box, Elements Prototype tab, described on page 183.

Note that the drainage area is automatically determined as you digitize it on the Plan View. However, you can over-ride this area by entering a different value in this field. If you want to have the software recompute all of the drainage areas based upon what is currently digitized in the Plan View, select **DESIGN ► RECOMPUTE AREAS**.



Minimum Areas

Note that the TR-20 and TR-55 hydrology methods can model drainage area as small as 0.0064 acres, but not smaller. This is because the analysis engine for the SCS (NRCS) TR-20 and TR-55 hydrology methods internally represent drainage areas in terms of square miles with a 5 decimal digit precision. This corresponds to a drainage area equal to 0.00001 mi² (i.e., 0.00640 acres, 279 ft², or 0.00259 hectares). Any drainage area smaller than this will cause an error message to be generated during the analysis.

Similarly, the HEC-1 hydrology method can model drainage area as small as 0.064 acres, but not smaller. This is because the analysis engine for the US Army Corps HEC-1 hydrology method internally represents drainage areas in terms of square miles with a 4 decimal digit precision. This corresponds to a drainage area equal to 0.0001 mi² (i.e., 0.0640 acres, 2790 ft², or 0.0259 hectares). Any drainage area smaller than this will cause an error message to be generated during the analysis.

Equivalent Width

Some time of concentration methods, such as Kinematic Wave as is used for the EPA SWMM hydrology method, require that an equivalent, rectangular subbasin (or *drainage flow plane*) be determined from the actual subbasin. As shown in the following figure, the hydrologic runoff response of this equivalent rectangular subbasin should closely match that of the actual subbasin.

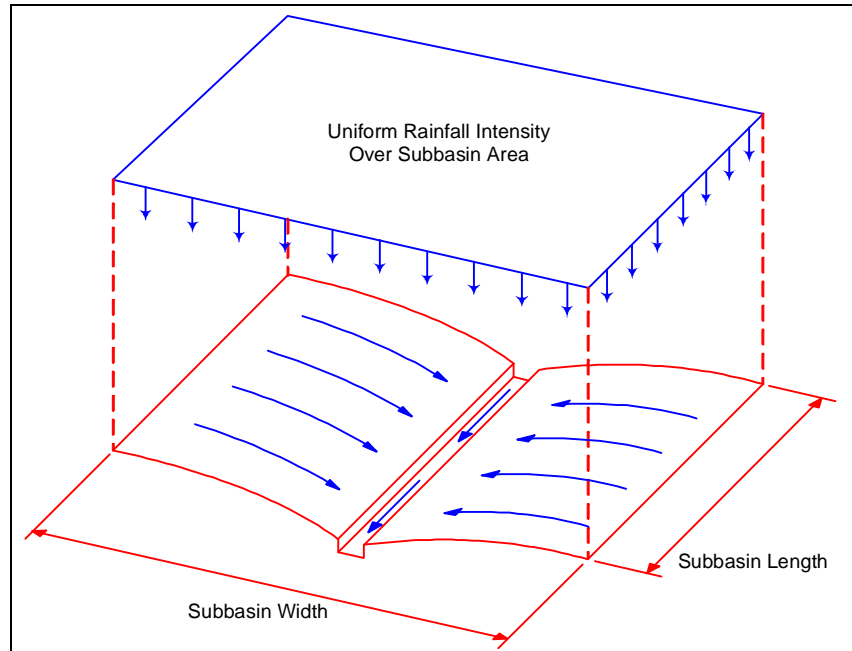
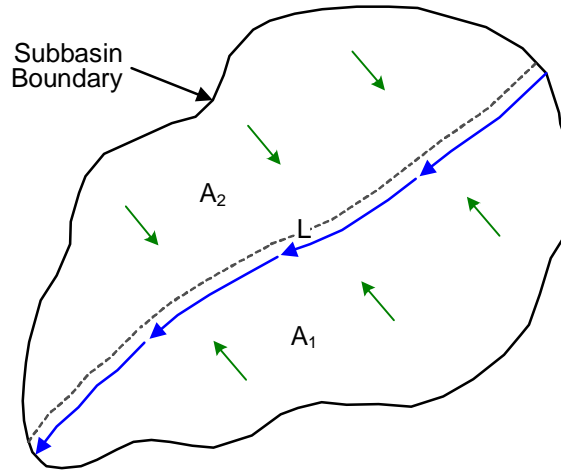

Figure 9.3 The constructed equivalent subbasin, used to determine the time of concentration, T_c , for certain T_c methods

In order to develop this equivalent rectangular subbasin, these methods use an equivalent (or sometimes called *characteristic*) width of the assumed rectangular subbasin in order to internally compute the overland flow path and the corresponding time of concentration. An initial estimate of the characteristic width is given by the subbasin area divided by the average maximum overland flow length, as shown in the following figure.

Subbasin Equivalent Width Computation

The following method can be used to compute the subbasin equivalent width



Subbasin Equivalent Width

$$W = (2 - S_k) \times L$$

Where:

$$S_k = \text{Skew factor } (0 = S_k = 1) = (A_2 - A_1) / (A_1 + A_2)$$

A_1 = Area on one side of the subbasin channel

A_2 = Area on other side of the subbasin channel

L = Length of subbasin channel

Figure 9.4 Method for computing an equivalent subbasin width for determining the time of concentration (T_c) for some T_c methods

Using the method as described in Figure 9.4 to compute an equivalent width, the software then develops a rectangular subbasin in which overland flow contributions from both pervious and impervious areas are idealized as running down-slope off the subbasin, as shown in Figure 9.3, to the subbasin outlet.

The maximum overland flow length is the length of the flow path from the inlet to the furthest drainage point (sometimes called a *concentration point* or *spill point*) of the subbasin. Maximum lengths from several different possible flow paths should be averaged. These paths should reflect slow flow, such as over pervious surfaces, more than rapid flow over pavement, for example.

Adjustments should be made to this width parameter to produce a good fit to measured runoff hydrographs. This value is generally a key parameter in calibrating peak flow and total runoff volume.

Average Slope

Specify the average slope (in percent) for the subbasin, for sheet flow and shallow concentrated flow. This value is used to compute the time of concentration for some T_c methods. The default average slope defined in the software is 0.5 % which is equivalent to 0.05 ft/ft.

Time of Concentration

Depending upon the time of concentration (Tc) method selected, this field may be a read-only field or allow you to specify a user-defined Tc. If the field is read-only, then the software uses other data to compute the Tc, and displays the computed Tc in this field. If *User Defined* was selected for the **TIME OF CONCENTRATION METHOD** in the Program Options dialog box (see page 167), then this field is used to define the Tc.

If this field is read-only, then click the browse button to display a summary report on the time of concentration computations, as shown in the following figure.

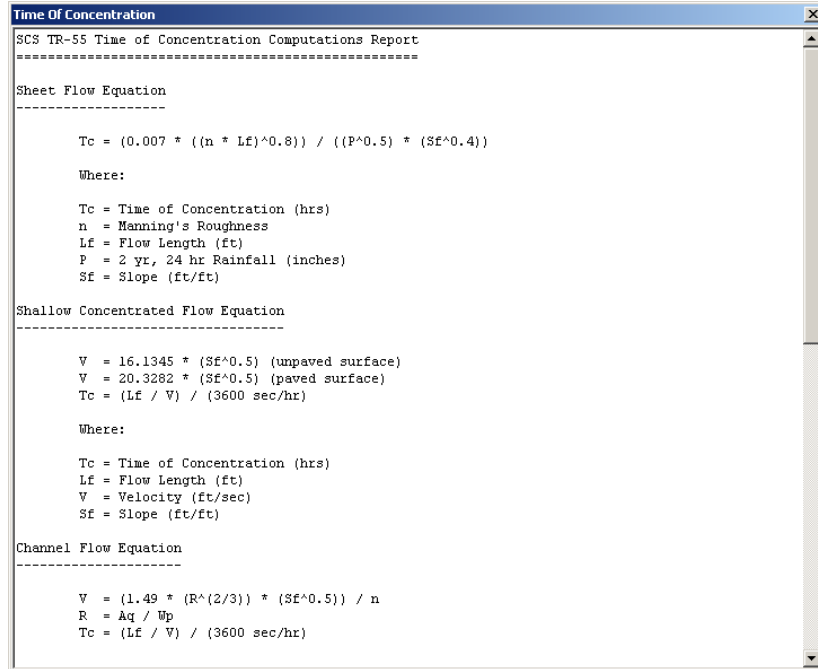

Figure 9.5 The summary report showing the time of concentration number computations for the current subbasin

As shown in the following figure, if this field is read-only (meaning that a Tc method other than user-defined has been selected), enabling the check box in front of this field allows you to override the Tc that is computed. The read-only field will change to an editable field, allowing you to define the Tc value to use. This allows you to override, on a subbasin-by-subbasin basis, the Tc that is computed with a user-defined Tc.

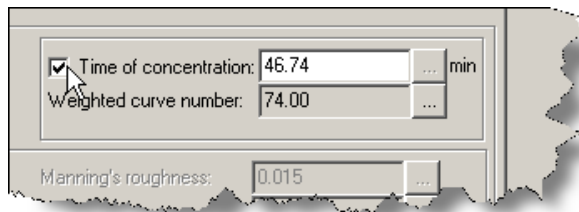

Figure 9.6 The check box allows you to override the computed Tc with a user-defined Tc value

Impervious Area

Specify the percentage of subbasin area that is impervious (i.e., roofs, asphalt or concrete roadways and sidewalks, etc.).

Impervious No Depression

Specify the percentage of the impervious area that has no depression storage.

Impervious Manning's Roughness

Specify the Manning's roughness coefficient for overland flow over the impervious portion of the subbasin. The Manning's roughness value for overland flow is an effective roughness coefficient that includes the effect of raindrop impact; drag over the plane surface; obstacles such as litter, crop ridges, and rocks; and erosion and transportation of sediment. These roughness values are for very shallow flow depths of about 0.1 foot or less.

Clicking the (...) browse button will display the Manning's Roughness reference dialog box, as shown in the following figure, which lists typical overland flow Manning's roughness values based upon land surface type (i.e., grassy or open soil, etc.).

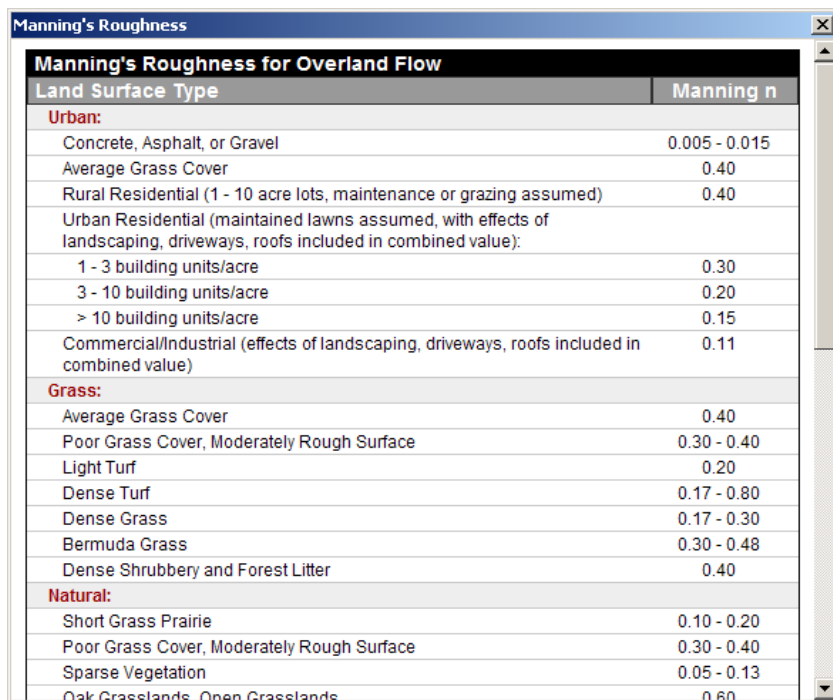

Land Surface Type	Manning n
Urban:	
Concrete, Asphalt, or Gravel	0.005 - 0.015
Average Grass Cover	0.40
Rural Residential (1 - 10 acre lots, maintenance or grazing assumed)	0.40
Urban Residential (maintained lawns assumed, with effects of landscaping, driveways, roofs included in combined value):	
1 - 3 building units/acre	0.30
3 - 10 building units/acre	0.20
> 10 building units/acre	0.15
Commercial/Industrial (effects of landscaping, driveways, roofs included in combined value)	0.11
Grass:	
Average Grass Cover	0.40
Poor Grass Cover, Moderately Rough Surface	0.30 - 0.40
Light Turf	0.20
Dense Turf	0.17 - 0.80
Dense Grass	0.17 - 0.30
Bermuda Grass	0.30 - 0.48
Dense Shrubbery and Forest Litter	0.40
Natural:	
Short Grass Prairie	0.10 - 0.20
Poor Grass Cover, Moderately Rough Surface	0.30 - 0.40
Sparse Vegetation	0.05 - 0.13
Oak Grasslands, Open Grasslands	0.60

Figure 9.7 The Manning's Roughness reference dialog box provides a listing of typical overland flow Manning's roughness values based upon land surface type

Impervious Depression Depth

Specify the depth of depression storage on the impervious portion of the subbasin (inches or mm). Surface storage is represented by a surface depression depth, such as localized depressions and other areas that will trap stormwater runoff, which must be satisfied before runoff from impervious surfaces can begin.

Note that this value is meant to account for "localized ponding" that one will see after a rainstorm, where there are little puddles scattered about. This field is only available with the EPA SWMM hydrology method.

Clicking the (...) browse button will display the Depression Depth reference dialog box, as shown in the following figure, which lists typical depression depth values based upon land surface type.

Typical Depression Storage Values		
Land Cover	Depression Storage	
	(inches)	(mm)
Impervious Surfaces	0.05 - 0.10	1.25 - 2.50
Lawns	0.10 - 0.20	2.50 - 5.00
Pasture	0.20	5.00
Forest Litter	0.30	7.50

Source: ASCE, (1992), Design & Construction of Urban Stormwater Management Systems, New York, NY.

Figure 9.8 The Depression Depth reference dialog box provides a listing of typical depression depth values based upon land surface type

Pervious Area Depression Depth

Specify the depth of depression storage on the pervious portion of the subbasin (inches or mm). Surface storage is represented by a surface depression depth, such as localized depressions and other areas that will trap stormwater runoff, which must be satisfied before runoff from impervious surfaces can begin. Generally, surface storage (and the equivalent depression depth) is greater for pervious areas than impervious areas, as represented by a higher degree of surface irregularity.

Note that this value is meant to account for “localized ponding” that one will see after a rainstorm, where there are little puddles scattered about. This field is only available with the EPA SWMM hydrology method.

Clicking the browse button will display the Depression Depth reference dialog box, as shown above in Figure 9.8, which lists typical depression depth values based upon land surface type.

Pervious Area Manning’s Roughness

Specify the Manning’s roughness coefficient for overland flow over the pervious portion of the subbasin (i.e., grassy or open soil, etc.). The Manning’s roughness value for overland flow is an effective roughness coefficient that includes the effect of raindrop impact; drag over the plane surface; obstacles such as litter, crop ridges, and rocks; and erosion and transportation of sediment. These roughness values are for very shallow flow depths of about 0.1 foot or less.

Clicking the browse button will display the Manning’s Roughness reference dialog box, as shown above in Figure 9.7, which lists typical overland flow Manning’s roughness values based upon land surface type (i.e., grassy or open soil, etc.).

Analysis Summary Section

The Subbasins dialog box provides a section titled **ANALYSIS SUMMARY** that provides a brief summary of the simulation results for the selected subbasin, as shown in the following figures. The simulation results that are provided vary depending upon the hydrology method being analyzed.

Analysis summary			
Peak runoff:	12.280	cfs	Rainfall intensity:
Total runoff:	1.016	in	Accumulated precipitation:
			2.420
			in

Figure 9.9 The Analysis Summary section of the Subbasins dialog box using Rational Method, Modified Rational, and DeKalb Rational hydrology methods

Analysis summary			
Peak runoff:	7.170	cfs	Total precipitation:
Total runoff:	2.298	in	Total infiltration:
			2.832
			in

Figure 9.10 The Analysis Summary section of the Subbasins dialog box using the SCS TR-20, SCS TR-55, and Santa Barbara Unit Hydrograph hydrology methods

Analysis summary			
Peak runoff:	0.52	cfs	TOC (days hh:mm:ss):
Total runoff:	0.722	in	Total infiltration:
			1.979
			in

Figure 9.11 The Analysis Summary section of the Subbasins dialog box using the EPA SWMM hydrology method

Analysis summary			
Peak runoff:	21.917	cfs	Total precipitation:
Total runoff:	1.927	in	Total infiltration:
			1.373
			in

Figure 9.12 The Analysis Summary section of the Subbasins dialog box using the US Army Corps hydrology method

A description of the available analysis result fields is provided below, listed in alphabetical order:

Accumulated Precipitation

This analysis output field provides the total amount of precipitation that fell on the selected subbasin based upon the time of concentration or storm duration, whichever was longer.

The software computes the rainfall intensity by reading the IDF curve data, using a duration that is the longer value of either:

- Time of concentration for the individual subbasin
- Storm duration, as defined in Project Options dialog

The software then computes the rainfall depth by dividing this intensity value by 60 (minutes into hours) and multiplying this value by the selected higher duration value.

Peak Runoff

This analysis output field provides the maximum runoff flow rate for the selected subbasin during the simulation period.

Rainfall Intensity

When using the Rational Method, Modified Rational, and DeKalb Rational hydrology methods, this analysis output field provides rainfall intensity computed for the selected subbasin based upon the storm duration and frequency.

TOC

When using the EPA SWMM hydrology method, this analysis output field provides the computed time of concentration that the software uses for the selected subbasin.

Total Infiltration

This analysis output field provides the total rainfall infiltration for the selected subbasin.

Total Precipitation

This analysis output field provides the total amount of precipitation that fell on the selected subbasin for the simulation period or storm duration, whichever was shorter.

Total Runoff

This analysis output field provides the total amount of precipitation that translates into stormwater runoff for the selected subbasin for the simulation period.

SCS TR-55 Curve Numbers

The SCS TR-55 Curve Number (CN) is a simple, widely used, and efficient method for determining the fraction of the precipitation depth that will translate into subbasin runoff. The curve number is based on the drainage area's hydrologic soil group, land use, and hydrologic condition. A high CN value (as high as 98 for paved roadways, roofs, and other impervious surfaces) causes nearly all of the precipitation to translate into runoff, where as a low CN value (as low as 30 for some conditions) causes most of the precipitation to be captured as infiltration and not translate into runoff.

Many of the hydrology methods provided in the software, such as SCS TR-20, SCS TR-55, EPA SWMM, and US Army Corps HEC-1, use SCS TR-55 Curve Number method.

Curve Number Tab

The Curve Number tab in the Subbasins dialog box, as shown in the following figure, defines the drainage area, land use, and soil property data for computing the

composite SCS curve number for the subbasin. Note that Curve Number tab may not be available (not displayed) based upon the **HYDROLOGY METHOD** selected in the Project Options dialog box, General tab, described on page 166. Note that up to 20 different subareas within the current subbasin can be defined, and the weighted (or composite) curve number will be computed and displayed at the bottom of the tab. In addition, the output report will contain the computations used to determine the weighted curve number for each subbasin.

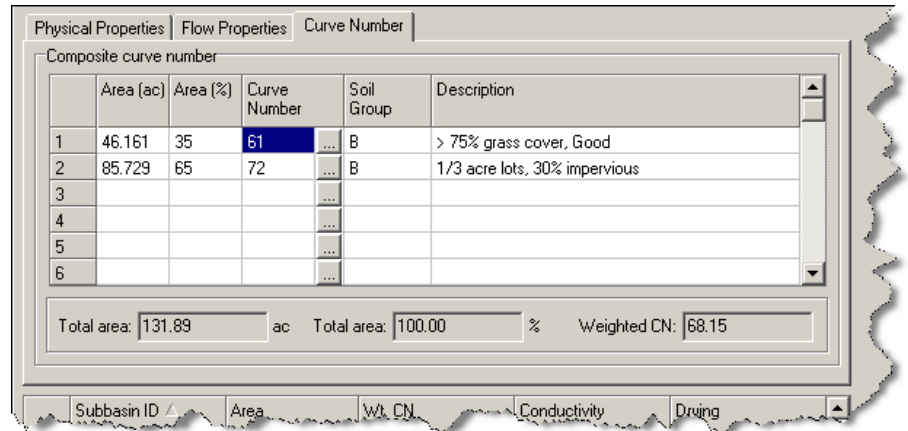

Figure 9.13 The Subbasins dialog box Curve Number tab

Area

These two columns define the drainage area (in acres, ft², hectares, or m², as well as %) for a subarea within the subbasin corresponding to a particular soil group and land use type. As the area is defined within one column, the corresponding area value is automatically computed in the other column based upon what was defined as the total subbasin area in the Physical Properties tab. For example, entering a value of 40% in the **AREA (%)** column for a 14.2 acre subbasin will cause a corresponding value of 5.68 acres to be automatically be computed and displayed in the **AREA (AC)** column.

Curve Number

This column defines the SCS curve number for the subarea within the subbasin corresponding to a particular soil group and land use type. Clicking the (...) browse button will display the Select Curve Number reference dialog box, as shown in the following figure. From the Select Curve Number reference dialog box, you can then select the appropriate curve number from the listing of

various soil groups and land uses. The software will then place the corresponding curve number, soil group, and description in the adjacent fields in the Curve Number tab.

Select Curve Number							
Select curve number from table							
	Description	Condition	A	B	C	D	Condensed Description
1	FULLY DEVELOPED URBAN AREAS	Vegetation					
2	Open space (lawns, parks, etc.)						
3	grass cover < 50%	Poor	68	79	86	89	< 50% grass cover, Poor
4	grass cover 50% to 75%	Fair	49	69	79	84	50 - 75% grass cover, Fair
5	grass cover > 75%	Good	39	61	74	80	> 75% grass cover, Good
6	Impervious Areas						
7	Paved parking lots, roofs, driveways		98	98	98	98	Paved parking & roofs
8	Streets and roads						
9	Paved: curbs and storm sewers		98	98	98	98	Paved roads with curbs & sewers
10	Paved: open ditches (with right-of-way)	50% imp	83	89	92	93	Paved roads with open ditches, 50% imp
11	Gravel (with right-of-way)		76	85	89	91	Gravel roads
12	Dirt (with right-of-way)		72	82	87	89	Dirt roads
13	Urban Districts	impervious					
14	Commercial & business	85% imp	89	92	94	95	Urban commercial, 85% imp
15	Industrial	72% imp	81	88	91	93	Urban industrial, 72% imp
16	Residential Districts						
17	(by average lot size)	impervious					
18	1/8 acre (town houses)	65% impervious	77	85	90	92	1/8 acre lots, 65% impervious
19	1/4 acre	38% impervious	61	75	83	87	1/4 acre lots, 38% impervious
20	1/3 acre	30% impervious	57	72	81	86	1/3 acre lots, 30% impervious
21	1/2 acre	25% impervious	54	70	80	85	1/2 acre lots, 25% impervious
22	1 acre	20% impervious	51	68	79	84	1 acre lots, 20% impervious
23	2 acre	12% impervious	46	65	77	82	2 acre lots, 12% impervious
24	Western Desert Urban Areas						
25	Natural desert (pervious areas only)		63	77	85	88	Natural western desert
26	Artificial desert landscaping		96	96	96	96	Artificial desert landscape
27	DEVELOPING URBAN AREA	(No Vegetation)					
28	Newly graded area (pervious only)		77	86	91	94	Newly graded area
29	CULTIVATED AGRICULTURAL LAND						
30	Fallow						
31	Bare soil		77	86	91	94	Fallow, bare soil
32	Crop residue (CR)	Poor	76	85	90	93	Fallow, crop residue, Poor

Figure 9.14 The Select Curve Number dialog box

Soil Group

This column references the soil group for the subarea within the subbasin corresponding to the selected curve number. This value is simply used as reference data when reporting the weighted curve number computations in the analysis output.

Description

This column describes the soil group and land use for the subarea within the subbasin corresponding to the selected curve number. This description is included as reference data when reporting the weighted curve number computations in the analysis output.

Editing & Customizing the Curve Number Table

The curve number table, as shown above in Figure 9.14, can be edited to customize the table for local regulations. From the Select Curve Number dialog box, click the Edit button and the Edit Curve Number Table dialog box will be presented, as shown in the following figure. Alternatively, select **DESIGN ► EDIT CURVE NUMBER TABLE** to display this dialog box. This dialog box allows you to edit the curve number table, change land type descriptions and corresponding values, as well as add or remove table rows.

Edit Curve Number Table							
Edit curve number table							
	Description	Condition	A	B	C	D	Condensed Description
1	FULLY DEVELOPED URBAN AREAS	Vegetation					
2	Open space (lawns, parks, etc.)						
3	grass cover < 50%	Poor	68	79	86	89	< 50% grass cover
4	grass cover 50% to 75%	Fair	49	69	79	84	50 - 75% grass cover
5	grass cover > 75%	Good	39	61	74	80	> 75% grass cover
6	Impervious Areas						
7	Paved parking lots, roofs, driveways		98	98	98	98	Paved parking & roofs
8	Streets and roads						
9	Paved: curbs and storm sewers		98	98	98	98	Paved roads with curbs & sewers
10	Paved: open ditches (with right-of-way)	50% imp	83	89	92	93	Paved roads with open ditches
11	Gravel (with right-of-way)		76	85	89	91	Gravel roads
12	Dirt (with right-of-way)		72	82	87	89	Dirt roads
13	Urban Districts	impervious					
14	Commercial & business	85% imp	89	92	94	95	Urban commercial
15	Industrial	72% imp	81	88	91	93	Urban industrial
16	Residential Districts						
17	(by average lot size)	impervious					
18	1/8 acre (town houses)	65% impervious	77	85	90	92	1/8 acre lots
19	1/4 acre	38% impervious	61	75	83	87	1/4 acre lots
20	1/3 acre	30% impervious	57	72	81	86	1/3 acre lots
21	1/2 acre	25% impervious	54	70	80	85	1/2 acre lots
22	1 acre	20% impervious	51	68	79	84	1 acre lots
23	2 acre	12% impervious	46	65	77	82	2 acre lots
24	Western Desert Urban Areas						
25	Natural desert (pervious areas only)		63	77	85	88	Natural western desert
26	Artificial desert landscaping		96	96	96	96	Artificial desert landscape
27	DEVELOPING URBAN AREA	(No Vegetation)					
28	Newly graded area (pervious only)		77	86	91	94	Newly graded area
29	CULTIVATED AGRICULTURAL LAND						
30	Fallow						
31	Bare soil		77	86	91	94	Fallow, bare soil
32	Crop residue (CR)	Poor	76	85	90	93	Fallow, crop residue

Figure 9.15 The Edit Curve Number Table dialog box allows you to customize the curve number table for local regulations

The entries within the Edit Curve Number Table dialog box can be interactively edited. In addition, this table can be edited in Microsoft Excel. To export this table to Excel, click the Save button. Once the Excel curve number spreadsheet has been edited, it can be reloaded back into the software by clicking the Load button.

Once the curve number table has been edited, all subsequent uses of the software will use the new table. However, previously created models will continue to use the originally defined curve numbers specified for the model subbasins.

To reset the edited curve number table back to its default state, click the Default button. The software will confirm that you want to restore this table back to its default state.

Runoff Coefficients

The Rational Method equation is the simplest method to determine peak discharge from drainage basin runoff. It is not as sophisticated as other hydrology methods, but is commonly used for determining peak flows for sizing sewer pipes, storm inlets, culverts, and small open channels. However, since the Rational Method was developed primarily for predicting peak flows, its use is not advised for volume-sensitive routing calculations (e.g., detention pond sizing).

The Rational Method (and Modified Rational Method) uses runoff coefficients in a similar fashion as the SCS TR-55 Method uses curve numbers estimating runoff. These runoff coefficients have been determined over the years and are a function of the soil type and drainage basin slope.

Runoff Coefficient Tab

The Runoff Coefficient tab, as shown in the following figure, defines the drainage area, land use, and soil property data for computing the composite runoff coefficient for the subbasin. Note that Runoff Coefficient tab may not be available (not displayed) based upon the **HYDROLOGY METHOD** selected in the Project Options dialog box, General tab, described on page 166. Note that up to 20 different subareas within the current subbasin can be defined, and the weighted (or composite) runoff coefficient will be computed and displayed at the bottom of the tab. In addition, the output report will contain the computations used to determine the weighted runoff coefficient for each subbasin.

Subbasin ID	Area (ac)	Area (%)	Runoff Coefficient	Soil Group	Description
1	46.161	35	0.24	B (0-2%)	Residential Lot Size 1/4 Acre, less than 25 years
2	85.729	65	0.08	B (0-2%)	Open Space, less than 25 years
3					
4					
5					
6					

Total area: 131.89 ac Total area: 100.00 % Weighted coeff: 0.14

Figure 9.16 The Subbasins dialog box Runoff Coefficient tab

Area

These two columns define the drainage area (in acres, ft², hectares, or m², as well as %) for a subarea within the subbasin corresponding to a particular soil group and land use type. As the area is defined within one column, the corresponding area value is automatically computed in the other column based upon what was defined as the total subbasin area in the Physical Properties tab. For example, entering a value of 40% in the **AREA (%)** column for a 14.2 acre subbasin will cause a corresponding value of 5.68 acres to be automatically be computed and displayed in the **AREA (AC)** column.

Runoff Coefficient

This column defines the runoff coefficient for the subarea within the subbasin corresponding to a particular soil group and land use type. Clicking the (...) browse button will display the Select Runoff Coefficient reference dialog box, as shown in the following figure. From the Select Runoff Coefficient reference dialog box, you can then select the appropriate runoff coefficient from the

listing of various soil groups and land uses. The software will then place the corresponding runoff coefficient, soil group, and description in the adjacent fields in the Runoff Coefficient tab.

Land Use	Return Period	A (0.2%)	A (2.6%)	A (6%)	B (0.2%)	B (2.6%)	B (6%+)	C (0.2%)	C (2.6%)	C (6%+)	D (0.2%)	D (2.6%)	D (6%+)
1 Cultivated Land	less than 25 years	0.08	0.13	0.16	0.11	0.15	0.21	0.14	0.19	0.26	0.18	0.23	0.31
2 Cultivated Land	25 years or greater	0.14	0.18	0.22	0.16	0.21	0.28	0.2	0.25	0.34	0.24	0.29	0.41
3 Pasture	less than 25 years	0.12	0.2	0.3	0.18	0.28	0.37	0.24	0.34	0.44	0.3	0.4	0.5
4 Pasture	25 years or greater	0.15	0.25	0.37	0.23	0.34	0.45	0.3	0.42	0.52	0.37	0.5	0.62
5 Meadow	less than 25 years	0.1	0.16	0.25	0.14	0.22	0.3	0.2	0.28	0.36	0.24	0.3	0.4
6 Meadow	25 years or greater	0.14	0.22	0.3	0.2	0.28	0.37	0.26	0.35	0.44	0.3	0.4	0.5
7 Forest	less than 25 years	0.05	0.08	0.11	0.08	0.11	0.14	0.1	0.13	0.16	0.12	0.16	0.2
8 Forest	25 years or greater	0.08	0.11	0.14	0.1	0.14	0.18	0.12	0.16	0.2	0.15	0.2	0.25
9 Residential Lot Size 1/8 Acre	less than 25 years	0.25	0.28	0.31	0.27	0.3	0.35	0.3	0.33	0.38	0.33	0.36	0.42
10 Residential Lot Size 1/8 Acre	25 years or greater	0.33	0.37	0.4	0.35	0.39	0.44	0.38	0.42	0.49	0.41	0.45	0.54
11 Residential Lot Size 1/4 Acre	less than 25 years	0.22	0.26	0.29	0.24	0.29	0.33	0.27	0.31	0.36	0.3	0.34	0.4
12 Residential Lot Size 1/4 Acre	25 years or greater	0.3	0.34	0.37	0.33	0.37	0.42	0.36	0.4	0.47	0.38	0.42	0.52
13 Residential Lot Size 1/3 Acre	less than 25 years	0.19	0.23	0.26	0.22	0.26	0.3	0.25	0.29	0.34	0.28	0.32	0.39
14 Residential Lot Size 1/3 Acre	25 years or greater	0.28	0.32	0.35	0.3	0.35	0.39	0.33	0.38	0.45	0.36	0.4	0.5
15 Residential Lot Size 1/2 Acre	less than 25 years	0.16	0.2	0.24	0.19	0.23	0.28	0.22	0.27	0.32	0.26	0.3	0.37
16 Residential Lot Size 1/2 Acre	25 years or greater	0.25	0.29	0.32	0.28	0.32	0.36	0.31	0.35	0.42	0.34	0.38	0.48
17 Residential Lot Size 1 Acre	less than 25 years	0.14	0.19	0.22	0.17	0.21	0.26	0.2	0.25	0.31	0.24	0.29	0.35
18 Residential Lot Size 1 Acre	25 years or greater	0.22	0.26	0.29	0.24	0.28	0.34	0.28	0.32	0.4	0.31	0.35	0.46
19 Industrial	less than 25 years	0.67	0.68	0.68	0.68	0.68	0.69	0.68	0.69	0.69	0.69	0.69	0.7
20 Industrial	25 years or greater	0.85	0.85	0.86	0.85	0.86	0.86	0.86	0.86	0.87	0.86	0.86	0.88
21 Commercial	less than 25 years	0.71	0.71	0.72	0.71	0.72	0.72	0.72	0.72	0.72	0.72	0.72	0.72
22 Commercial	25 years or greater	0.88	0.88	0.89	0.89	0.89	0.89	0.89	0.89	0.89	0.89	0.89	0.9
23 Streets	less than 25 years	0.7	0.71	0.72	0.71	0.72	0.74	0.72	0.73	0.76	0.73	0.75	0.78
24 Streets	25 years or greater	0.76	0.77	0.79	0.8	0.82	0.84	0.84	0.85	0.89	0.89	0.91	0.95
25 Open Space	less than 25 years	0.05	0.1	0.14	0.08	0.13	0.19	0.12	0.17	0.24	0.16	0.21	0.28
26 Open Space	25 years or greater	0.11	0.16	0.2	0.14	0.19	0.26	0.18	0.23	0.32	0.22	0.27	0.39
27 Parking	less than 25 years	0.85	0.86	0.87	0.85	0.86	0.87	0.85	0.86	0.87	0.85	0.86	0.87
28 Parking	25 years or greater	0.95	0.96	0.97	0.95	0.96	0.97	0.95	0.96	0.97	0.95	0.96	0.97

Figure 9.17 The Select Runoff Coefficient dialog box

Soil Group

This column references the soil group for the subarea within the subbasin corresponding to the selected runoff coefficient. This value is simply used as reference data when reporting the weighted runoff coefficient computations in the analysis output.

Description

This column describes the soil group and land use for the subarea within the subbasin corresponding to the selected runoff coefficient. This description is included as reference data when reporting the weighted runoff coefficient computations in the analysis output.

Editing & Customizing the Runoff Coefficient Table

The runoff coefficient table, as shown above in Figure 9.17, can be edited to customize the table for local regulations. From the Select Runoff Coefficient dialog box, click the Edit button and the Edit Runoff Coefficient Table dialog box will be presented, as shown in the following figure. Alternatively, select **DESIGN ► EDIT RUNOFF COEFFICIENT TABLE** to display this dialog box. This dialog box allows you to edit the runoff coefficient table, change land type descriptions and corresponding values, as well as add or remove table rows.

Edit Runoff Coefficient Table														Default...
Edit runoff coefficient table														Load...
Land Use	Return Period	A (0-2%)	A (2-6%)	A (6%+)	B (0-2%)	B (2-6%)	B (6%+)	C (0-2%)	C (2-6%)	C (6%+)	D (0-2%)	D (2-6%)	D (6%+)	Save...
1	Cultivated Land	less than 25 years	0.08	0.13	0.16	0.11	0.15	0.21	0.14	0.19	0.26	0.18	0.23	0.31
2	Cultivated Land	25 years or greater	0.14	0.18	0.22	0.16	0.21	0.28	0.2	0.25	0.34	0.24	0.29	0.41
3	Pasture	less than 25 years	0.12	0.2	0.3	0.18	0.28	0.37	0.24	0.34	0.44	0.3	0.4	0.5
4	Pasture	25 years or greater	0.15	0.25	0.37	0.23	0.34	0.45	0.3	0.42	0.52	0.37	0.5	0.62
5	Meadow	less than 25 years	0.1	0.16	0.25	0.14	0.22	0.3	0.2	0.28	0.36	0.24	0.3	0.4
6	Meadow	25 years or greater	0.14	0.22	0.3	0.2	0.28	0.37	0.26	0.35	0.44	0.3	0.4	0.5
7	Forest	less than 25 years	0.05	0.08	0.11	0.08	0.11	0.14	0.1	0.13	0.16	0.12	0.16	0.2
8	Forest	25 years or greater	0.08	0.11	0.14	0.1	0.14	0.18	0.12	0.16	0.2	0.15	0.2	0.25
9	Residential Lot Size 1/8 Acre	less than 25 years	0.25	0.28	0.31	0.27	0.3	0.35	0.3	0.33	0.38	0.33	0.36	0.42
10	Residential Lot Size 1/8 Acre	25 years or greater	0.33	0.37	0.4	0.35	0.39	0.44	0.38	0.42	0.49	0.41	0.45	0.54
11	Residential Lot Size 1/4 Acre	less than 25 years	0.22	0.26	0.29	0.24	0.29	0.33	0.27	0.31	0.36	0.3	0.34	0.4
12	Residential Lot Size 1/4 Acre	25 years or greater	0.3	0.34	0.37	0.33	0.37	0.42	0.36	0.4	0.47	0.38	0.42	0.52
13	Residential Lot Size 1/3 Acre	less than 25 years	0.19	0.23	0.26	0.22	0.26	0.3	0.25	0.29	0.34	0.28	0.32	0.39
14	Residential Lot Size 1/3 Acre	25 years or greater	0.28	0.32	0.35	0.3	0.35	0.39	0.33	0.38	0.45	0.36	0.4	0.5
15	Residential Lot Size 1/2 Acre	less than 25 years	0.16	0.2	0.24	0.19	0.23	0.28	0.22	0.27	0.32	0.26	0.3	0.37
16	Residential Lot Size 1/2 Acre	25 years or greater	0.25	0.29	0.32	0.28	0.32	0.36	0.31	0.35	0.42	0.34	0.38	0.48
17	Residential Lot Size 1 Acre	less than 25 years	0.14	0.19	0.22	0.17	0.21	0.26	0.2	0.25	0.31	0.24	0.29	0.35
18	Residential Lot Size 1 Acre	25 years or greater	0.22	0.26	0.29	0.24	0.28	0.34	0.28	0.32	0.4	0.31	0.35	0.46
19	Industrial	less than 25 years	0.67	0.68	0.68	0.68	0.68	0.69	0.68	0.69	0.69	0.69	0.69	0.7
20	Industrial	25 years or greater	0.85	0.85	0.86	0.85	0.86	0.86	0.86	0.86	0.87	0.86	0.86	0.88
21	Commercial	less than 25 years	0.71	0.71	0.72	0.71	0.72	0.72	0.72	0.72	0.72	0.72	0.72	0.72
22	Commercial	25 years or greater	0.88	0.88	0.89	0.89	0.89	0.89	0.89	0.89	0.9	0.89	0.89	0.9
23	Streets	less than 25 years	0.7	0.71	0.72	0.71	0.72	0.74	0.72	0.73	0.76	0.73	0.75	0.78
24	Streets	25 years or greater	0.76	0.77	0.79	0.8	0.82	0.84	0.84	0.85	0.89	0.89	0.91	0.95
25	Open Space	less than 25 years	0.05	0.1	0.14	0.08	0.13	0.19	0.12	0.17	0.24	0.16	0.21	0.28
26	Open Space	25 years or greater	0.11	0.16	0.2	0.14	0.19	0.26	0.18	0.23	0.32	0.22	0.27	0.39
27	Parking	less than 25 years	0.85	0.86	0.87	0.85	0.86	0.87	0.85	0.86	0.87	0.85	0.86	0.87
28	Parking	25 years or greater	0.95	0.96	0.97	0.95	0.96	0.97	0.95	0.96	0.97	0.95	0.96	0.97

Figure 9.18 The Edit Runoff Coefficient Table dialog box allows you to customize the runoff coefficient table for local regulations

The entries within the Edit Runoff Coefficient Table dialog box can be interactively edited. In addition, this table can be edited in Microsoft Excel. To export this table to Excel, click the Save button. Once the Excel runoff coefficient spreadsheet has been edited, it can be reloaded back into the software by clicking the Load button.

Once the runoff coefficient table has been edited, all subsequent uses of the software will use the new table. However, previously created models will continue to use the originally defined runoff coefficients specified for the model subbasins.

To reset the edited runoff coefficient table back to its default state, click the Default button. The software will confirm that you want to restore this table back to its default state.

SCS TR-55 TOC Method

The time of concentration (T_c) is defined as the time required for runoff to travel from the hydraulically most distant point of the subbasin to where the runoff leaves the subbasin (*concentration point* or *spill point*). Runoff moves through the subbasin as sheet flow, shallow concentrated flow, open channel flow, or some combination of these. The type of runoff flow that occurs is a function of the subbasin conveyance system and is best determined by field inspection. The time of concentration is determined by summing together all of the individual runoff travel times within the subbasin.

SCS TR-55 TOC Tab

Note that SCS TR-55 TOC tab is only available if the **SCS TR-55 TOC** method is selected from the **TIME OF CONCENTRATION (TOC) METHOD** drop-down list in the Project Options dialog box, General tab, described on page 167. As shown in the following figure, the software provides three sub-tabs within the SCS TR-55 TOC tab for defining the different components (i.e., sheet flow, shallow concentrated flow, and open channel flow) of runoff flow. In addition, the software allows three subareas within each subbasin to further refine the computation of runoff travel time and the corresponding time of concentration.

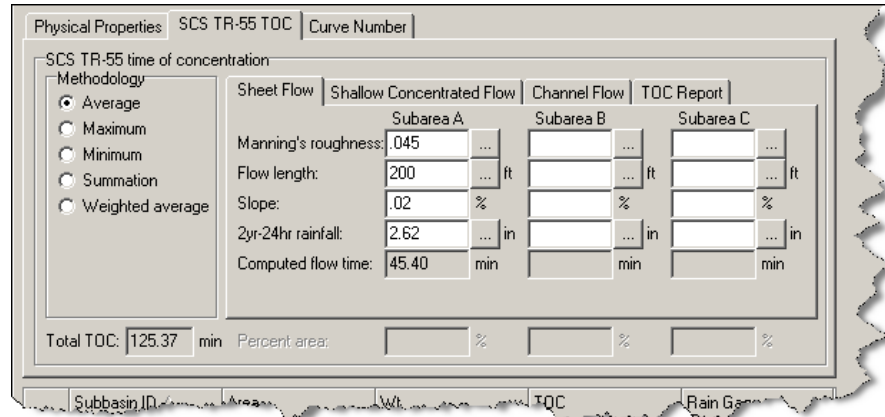

Figure 9.19 The Subbasins dialog box SCS TR-55 TOC tab

Note that not each sub-tab nor subarea needs to be completed with data in order to compute the time of concentration for a subbasin. For example, a small parking lot subbasin might only contain sheet flow runoff. For larger subbasins, there might be up to three subareas that drain in series to each other, and by using the **SUMMATION** methodology, you can define the TOC components for each subarea and determine a very accurate time of concentration for the entire subbasin.

Methodology

Note that up to 3 different subareas within the current subbasin can be defined, and the time of concentration (TOC) computed based upon the methodology selected as detailed below. It will consider the summation of

sheet flow, shallow concentrated flow, and channel flow as the total TOC for a subarea. If there is only one subbasin subarea defined, then whatever option is selected is ignored.

- Average** Computes an average TOC for up to three subareas within the same subbasin. For example, if the TOC for the subareas are 12:32, 9:56, and 7:47 min:sec, the resultant subbasin TOC is $(12:32 + 9:56 + 7:47) / 3 = 10:05$ min:sec.
- Maximum** Selects the maximum TOC for up to three subareas within the same subbasin. For example, if the TOC for the subareas are 12:32, 9:56, and 7:47 min:sec, the resultant subbasin TOC is 12:32 min:sec. This method is good for determining the most hydraulically distant TOC flow path.
- Minimum** Selects the minimum TOC for up to three subareas within the same subbasin. For example, if the TOC for the subareas are 12:32, 9:56, and 7:47 min:sec, the resultant subbasin TOC is 7:47 min:sec.
- Summation** Sums the TOC for up to three subareas within the same subbasin. This is commonly used for different subareas that flow into each other in sequence (or series).

For example, a subarea sheet flow and shallow concentrated flow might have a combined TOC of 6:43 min:sec, which then flows into another subarea with a sheet flow, shallow concentrated flow, and channel flow combined TOC of 12:32 min:sec, which flows into another subarea with only a channel flow TOC of 2:12 min:sec. This methodology option would have a summed TOC of $6:43 + 12:32 + 2:12 = 21:27$ min:sec.

Another common situation where this method can be applied is when there is a significant change in the TOC flow path (i.e., ground cover or slope). You may need to use multiple segments to represent the separate TOC computations (e.g., Sheet Flow A -> Shallow Flow A -> Shallow Flow B -> Channel Flow A).

- Weighted Average** Computes a weighted average TOC (based upon percentage area) for up to three subareas within the same subbasin. For example, if the TOC for the subareas are 12:32, 9:56, and 7:47 min:sec for percentage areas of 72, 18, and 10%, the resultant subbasin TOC is $[(12:32 \times 72\%) + (9:56 \times 18\%) + (7:47 \times 10\%)] / 100\% = 11:35$ min:sec.

As you enter data into each of the tabs, the software automatically computes the time of concentration for each runoff component as well as the total time of concentration for the entire subbasin and displays this at the bottom of the tab. To see a complete report of the computed SCS TR-55 time of concentration, click the **TOC REPORT** tab. As shown in the following figure, you can right-click the computed report in the **TOC REPORT** tab and select to export the report to Microsoft Word, Excel, or to other output sources. In addition, the output report will contain the computations used to determine the SCS TR-55 time of concentration for each subbasin.

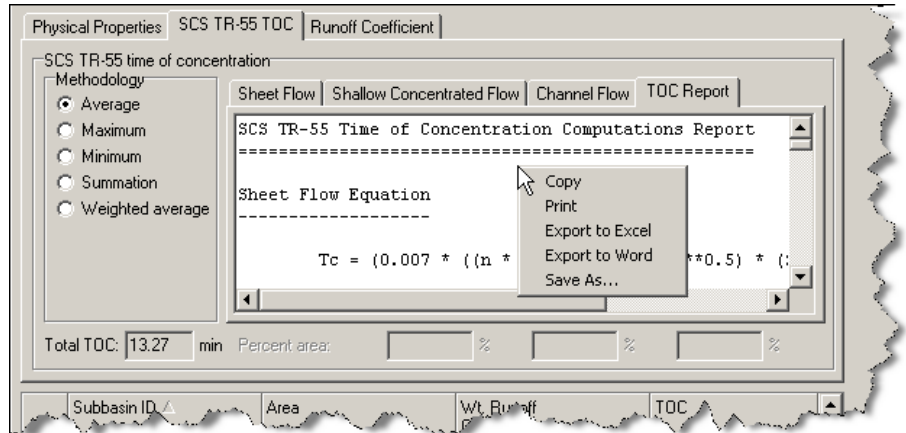

Figure 9.20 The SCS TR-55 TOC Report tab allows you to review the TOC computations, as well as export the report to Microsoft Word or Excel

SCS TR-55 TOC Sheet Flow Tab

The SCS TR-55 TOC Sheet Flow sub-tab, as shown in the following figure, defines the data for computing the contributing sheet flow runoff time of concentration (TOC) for a subbasin. Sheet flow is runoff that flows over the ground as a thin, even layer rather than concentrated flow, and occurs at the headwater of a subbasin. After a maximum of 300 feet, sheet flow usually becomes shallow concentrated flow.

Note that the TOC is automatically computed as data are entered into the sheet flow tab, displayed at the bottom of the tab. In addition, the **TOC REPORT** tab and the output report will contain the computations used to determine the TOC for each subbasin. If there is no sheet flow for the current subbasin, then this tab should remain blank.

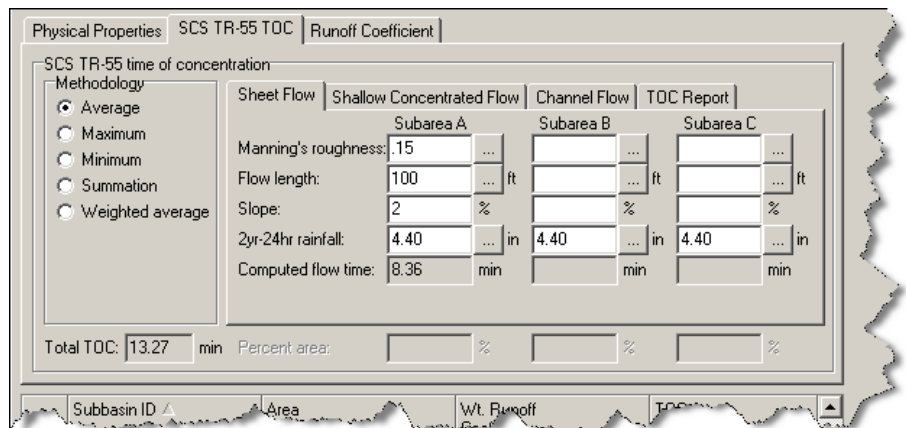

Figure 9.21 The SCS TR-55 TOC Sheet Flow tab

Manning's Roughness

Specify the Manning's roughness coefficient for the sheet flow portion of the subarea. The Manning's roughness value for sheet flow is an effective roughness coefficient that includes the effect of raindrop impact; drag over the plane surface; obstacles such as litter, crop ridges, and rocks; and erosion and transportation of sediment. These roughness values are for very shallow flow depths of about 0.1 foot or less.

Clicking the browse button will display the Manning's Roughness reference dialog box, as shown previously in Figure 9.7 on page 325, which lists typical overland flow Manning's roughness values based upon land surface type (i.e., grassy or open soil, etc.).

Flow Length

Specify the flow length for the sheet runoff flow. Click the browse button in order to measure this distance from the Plan View. The software will temporarily hide the Subbasin dialog box while you trace the sheet runoff flow path on the subbasin. When completed measuring this distance, right-click or press Enter and the measured distance will be placed in the **FLOW LENGTH** field.

Generally, runoff sheet flow should not be longer than 300 ft. In addition, local stormwater regulations may limit this flow length to an even shorter distance. The NRCS has determined that sheet flow will not occur for more than 300 ft regardless of the evenness of the runoff surface, and recommends a maximum sheet flow length of 100 ft. Regardless, when sheet flow ends, the remainder of the runoff flow path can be defined using shallow concentrated flow and/or channel flow lengths.

Slope

Specify the average slope (in percent) for the sheet flow.

2yr-24hr Rainfall

Specify the 2-year 24-hour rainfall amount in inches. Click the browse button to display the 2yr-24hr Rainfall lookup dialog box, as shown in the following figure. This dialog box allows you to lookup rainfall amounts of all counties and major metropolitan areas within the USA using a comprehensive rainfall database that comes along with the software. Note that the rainfall values retrieved using the dialog box should be cross-checked with local available data. If you find that the data provided with the software is not up-to-date for your area, please provide us with the correct rainfall data so that we can update the rainfall database for the next release of the software.

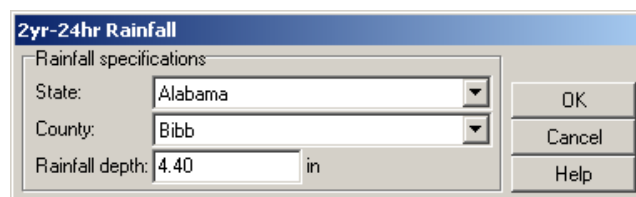

Figure 9.22 The 2yr-24hr Rainfall lookup dialog box provides rainfall data for the entire USA for all counties and major metro areas

Percent Area

When using the **WEIGHTED AVERAGE** SCS TR-55 TOC Method (see page 335), then these fields are available and are used to specify the percentage area for up to three subareas within the subbasin for computing a weighted average time of concentration for the subbasin.

SCS TR-55 TOC Shallow Concentrated Flow Tab

The SCS TR-55 TOC Shallow Concentrated Flow sub-tab, as shown in the following figure, defines the data for computing the contributing shallow concentrated flow runoff time of concentration (TOC) for a subbasin. Generally, after a maximum of 300 feet, sheet flow usually becomes shallow concentrated overland flow. Tillage can affect the direction of shallow concentrated flow. Flow may not always be directly down the watershed slope if tillage runs across the slope. For an urban

subbasin where flow is mainly in streets and no primary channels exist, an average flow path should be selected—such as a line parallel to grade from the subbasin outlet to the watershed’s upper boundary.

Note that the TOC is automatically computed as data are entered into the shallow concentrated flow tab, displayed at the bottom of the tab. In addition, the **TOC REPORT** tab and the output report will contain the computations used to determine the TOC for each subbasin. If there is no shallow concentrated flow for the current subbasin, then this tab should remain blank.

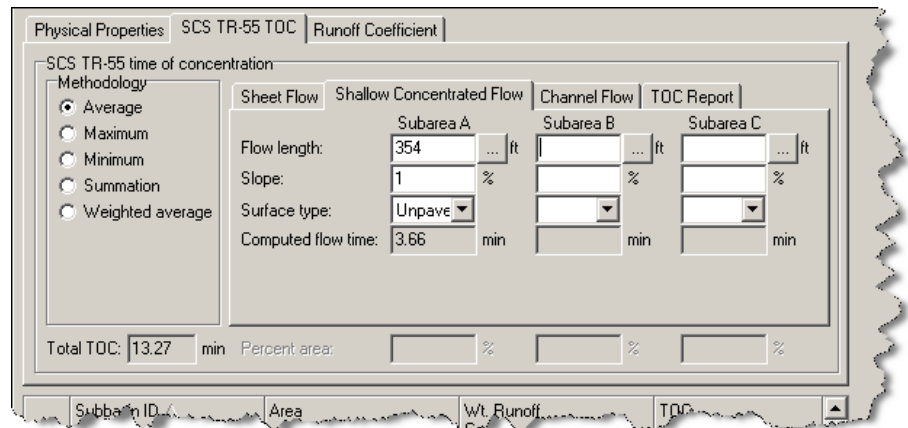

Figure 9.23 The SCS TR-55 TOC Shallow Concentrated Flow tab

Flow Length

Specify the flow length for the shallow concentrated runoff flow. Click the browse button in order to measure this distance from the Plan View. The software will temporarily hide the Subbasin dialog box while you trace the shallow concentrated runoff flow path on the subbasin. When completed measuring this distance, right-click or press Enter and the measured distance will be placed in the **FLOW LENGTH** field.

Slope

Specify the average slope (in percent) for the shallow concentrated flow.

Surface Type

From the drop-down list, select the appropriate conditions for computing the shallow concentrated flow travel time. The surface types and corresponding velocity factors (K_v) are provided:

Surface Type	K_v (ft/sec)	K_v (m/sec)
Paved	20.33	6.20
Unpaved	16.13	4.92
Grassed Waterway	15.0	4.57
Nearly Bare & Untilled	10.0	3.05
Cultivated Straight Rows	9.0	2.74
Short Grass Pasture	7.0	2.13
Woodland	5.0	1.52
Forest w/ Heavy Litter	2.5	0.76

The SCS TR-55 Shallow Concentrated Flow computational procedure is of the same mathematical form as is used in the NRCS Upland Method (*USDA NRCS NEH National Engineering Handbook, Chapter 15, Travel Time, Time of*

Concentration and Lag, August 1972). The basic difference between the two methods is that the SCS TR-55 Shallow Concentrated Flow methodology utilizes only two surface types, paved and unpaved. Due to the similarity between these two methods, the software includes the capabilities in the NRCS Upland Method in order to provide you additional flexibility in computing the shallow concentrated flow time of concentration.

The NRCS Upland Method is designed for the computation of TOC of a watershed headwaters, including overland flow, grassed waterways, paved segments, and small upland gullies, and is applicable for watershed subbasins of 2000 acres or less. The NRCS Upland Method was published with a log-log graph of velocities versus slope for various surface types. The method is based upon the following equation, and is applicable to both US units and SI metric units as long as the correct velocity factor (or direct velocity) is used.

$$T_t = \frac{L}{V}$$

$$V = K_v \sqrt{S}$$

where:

- T_t = travel time
- L = flow length
- V = average velocity
- K_v = velocity factor (see previous table)
- S = land slope, along flow path (rise/run)

Velocity

Specify the velocity of the shallow concentrated flow (ft/sec or m/sec).

Selecting the surface type from the **SURFACE TYPE** drop-down list will cause the software to automatically compute the shallow concentrated flow velocity based upon what was specified for **SLOPE**. However, to provide additional flexibility, you can directly enter the shallow concentrated flow velocity (overwriting the value that was automatically computed) for the specific conditions present in the subbasin.

Clicking the browse button will display the NRCS Velocity Chart reference dialog box, similar to the chart shown in the following figure. This dialog box will allow you to determine the appropriate velocity based upon surface type and slope.

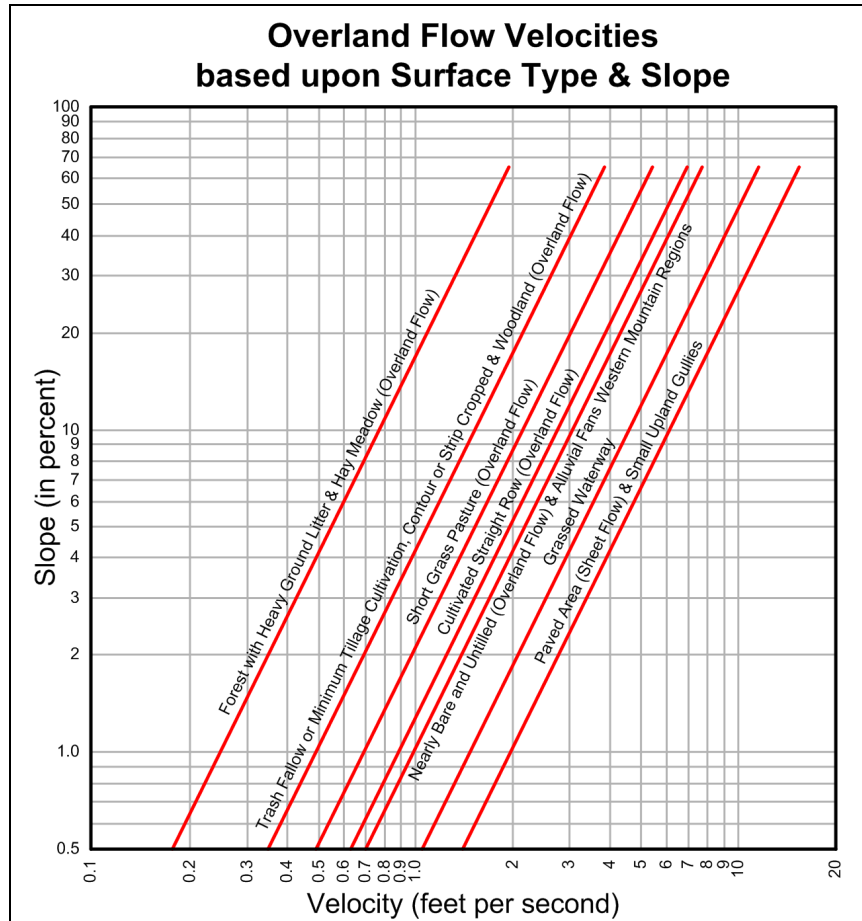

Figure 9.24 Chart showing how to determine overland flow velocities based upon surface type and slope

SCS TR-55 TOC Channel Flow Tab

The SCS TR-55 TOC Channel Flow sub-tab, as shown in the following figure, defines the data for computing the contributing runoff channelized flow time of concentration (TOC) for a subbasin. Channelized flow is assumed to begin where surveyed cross section information has been obtained, where channels are visible on aerial photographs, or where blue lines (indicating streams) appear on United States Geological Survey (USGS) quadrangle sheets.

Note that the channel flow segment used to compute the SCS TR-55 TOC should be an actual stream channel. Keep in mind that the flow velocity and travel time for channel flow are relatively insensitive to the exact flow depth. Hence, an exact cross section area and wetted perimeter are generally not required. Furthermore, the channel flow segment is usually a small fraction of the overall TOC and therefore the overall sensitivity to flow depth is reduced even further.

If the channel travel time is a significant portion of the overall TOC, such as would occur in a large subbasin, it may be necessary to further subdivide the subbasin and then define a separate routing reach rather than including the channel flow segment in the TOC calculations.

Note that the TOC is automatically computed as data are entered into the channel flow tab, displayed at the bottom of the tab. In addition, the **TOC REPORT** tab and the output report will contain the computations used to determine the TOC for

each subbasin. If there is no channel flow for the current subbasin, then this tab should remain blank.

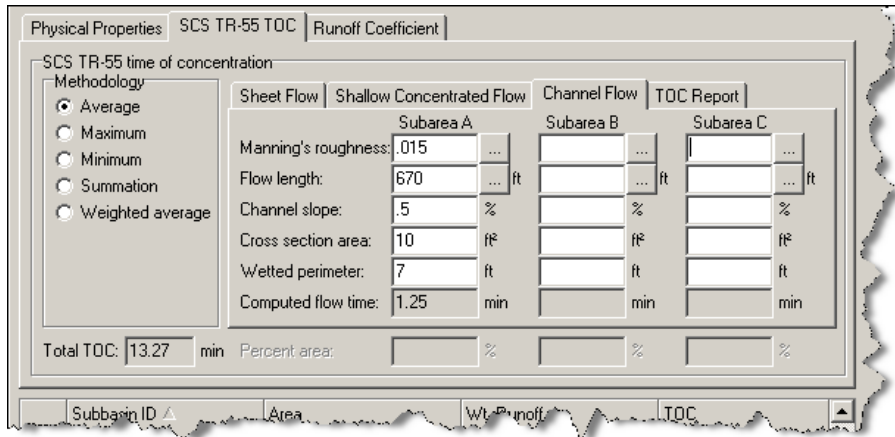

Figure 9.25 The SCS TR-55 TOC Channel Flow tab

Manning's Roughness

Specify the Manning's roughness coefficient for the channelized flow portion of the subarea. Clicking the (...) browse button will display the Manning's Roughness reference dialog box, as shown in the following figure, which lists typical channelized flow Manning's roughness values based upon channel type (i.e., lined, excavated, or natural channel, etc.).

Manning's Roughness n for Open Channels			
Channel Type	Manning n		
	Minimum	Normal	Maximum
1. Lined or Constructed Channels			
a. Cement:			
1. Neat, surface	0.010	0.011	0.013
2. Mortar	0.011	0.013	0.015
b. Concrete:			
1. Trowel finish	0.011	0.013	0.015
2. Float finish	0.013	0.015	0.016
3. Finished, with gravel on bottom	0.015	0.017	0.020
4. Unfinished	0.014	0.017	0.020
5. Gunite, good section	0.016	0.019	0.023
6. Gunite, wavy section	0.018	0.022	0.025
7. On good excavated rock	0.017	0.020	-
8. On irregular excavated rock	0.022	0.027	-
c. Concrete Bottom Float Finish with sides of:			
1. Dressed stone in mortar	0.015	0.017	0.020
2. Random stone in mortar	0.017	0.020	0.024
3. Cement rubble masonry, plastered	0.016	0.020	0.024
4. Cement rubble masonry	0.020	0.025	0.030
5. Dry rubble or riprap	0.020	0.030	0.035
d. Gravel Bottom with sides of:			
1. Formed concrete	0.017	0.020	0.025
2. Random stone mortar	0.020	0.022	0.026

Figure 9.26 The Manning's Roughness reference dialog box for channelized runoff flow

Flow Length

Specify the flow length for the channelized runoff flow. Click the (...) browse button in order to measure this distance from the Plan View. The software will temporarily hide the Subbasin dialog box while you trace the channelized

runoff flow path from the subbasin. When completed measuring this distance, right-click or press Enter and the measured distance will be placed in the **FLOW LENGTH** field.

Channel Slope

Specify the average channel bed slope (in percent) for the channelized flow.

Cross Section Area

Specify the cross section area, in ft^2 or m^2 , of the channel experiencing bankfull conditions. An approximate value can be entered to estimate the time of concentration.

Wetted Perimeter

Specify the cross section wetted perimeter, in ft or m, of the channel experiencing bankfull conditions. An approximate value can be entered to estimate the time of concentration.

EPA SWMM Hydrology Method

The EPA SWMM hydrology method can be used for single storm events to long-term (continuous) simulation of the surface runoff/subsurface runoff quantity and water quality. The EPA SWMM hydrology method is used primarily for urban/suburban areas, and operates on a collection of subcatchment areas within a subbasin that receive precipitation and generate runoff and pollutant loads after simulation of evaporation and infiltration losses from the subcatchments.

Flow Properties Tab

The Flow Properties tab, as shown in Figures 9.27 through 9.29, defines additional flow data specific to subbasins when using the EPA SWMM hydrology method, as defined in the Project Options dialog box, General tab, described on page 166. Note that some of the data entry fields provided in this section may be grayed out (or unavailable) since some data fields are applicable to only certain infiltration methods. Note that the Flow Properties tab is not displayed if a hydrology method other than the EPA SWMM method is selected.

The screenshot shows the 'Flow Properties' tab of the 'Subbasins' dialog box. The tab is divided into two columns of input fields. The left column includes: 'Curve number' (80.00), 'Conductivity' (0.15 in/hr), 'Drying time' (7 days), 'Decay constant' (1/hr), 'Max volume' (in), and 'Internal runoff routed' (100%). The right column includes: 'Land types' (2), 'Initial pollutants' (NONE), 'Curb & gutter length' (0 ft), 'Groundwater aquifer' (NO), 'Snow pack' (dropdown), and 'Internal routing' (Direct to outlet dropdown). At the bottom, there are summary fields for 'Subbasin ID', 'Area', 'Wt. CN', 'Conductivity', and 'Drying'.

Figure 9.27 The Subbasins dialog box Flow Properties tab for EPA SWMM hydrology method and SCS Curve Number infiltration method

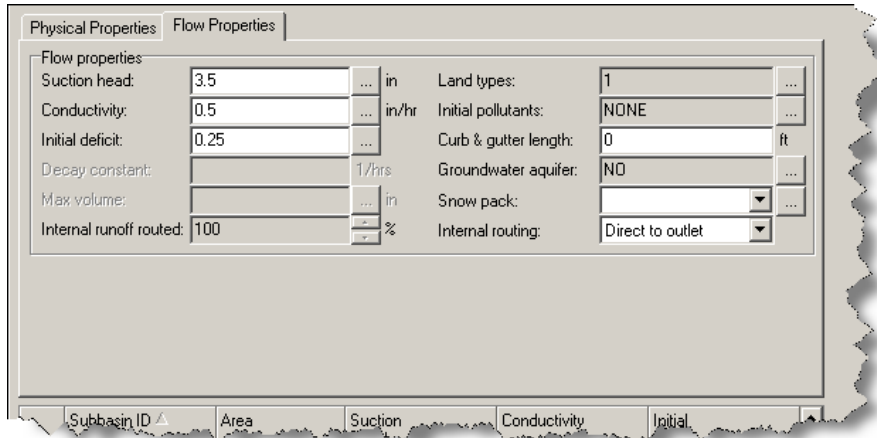

Figure 9.28 The Subbasins dialog box Flow Properties tab for EPA SWMM hydrology method and Green Ampt infiltration method

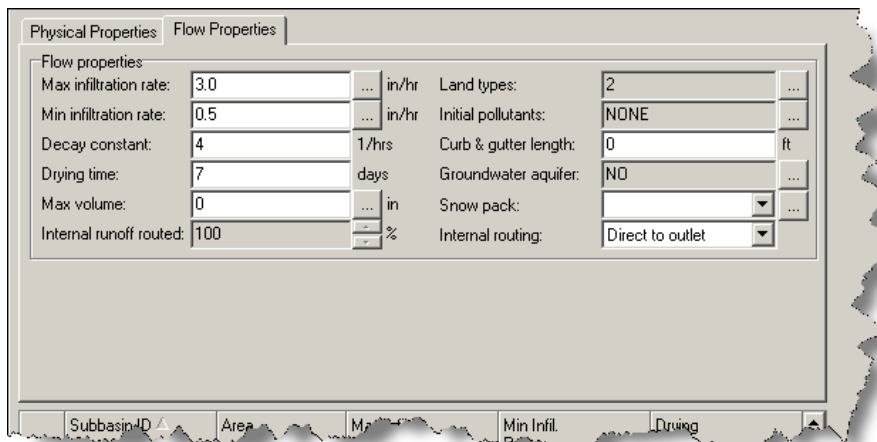

Figure 9.29 The Subbasins dialog box Flow Properties tab for EPA SWMM hydrology method and Horton infiltration method

Curve Number (SCS Infiltration only)

This field is read-only, and represents the composite SCS curve number that was computed from the Curve Number tab. Click the (...) browse button to display a summary report on the composite curve number computations, as shown in the following figure.

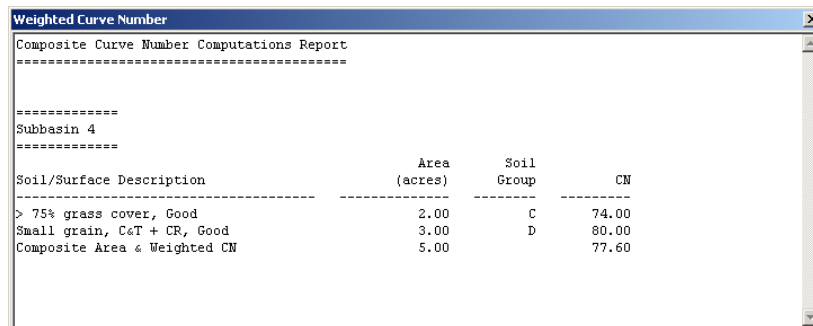

Figure 9.30 The summary report showing the composite curve number computations for the current subbasin

The curve number is based on the drainage area's hydrologic soil group, land use, and hydrologic condition. A high CN value (as high as 98 for paved roadways, roofs, and other impervious surfaces) causes nearly all of the precipitation to translate into runoff, where as a low CN value (as low as 30 for some conditions) causes most of the precipitation to be captured as infiltration and not translate into runoff. Further information on curve numbers is detailed in the section titled *SCS TR-55 Curve Numbers* on page 328.

Conductivity (Green-Ampt only)

This value denotes the soil's saturated hydraulic conductivity (in/hr or mm/hr). Clicking the (...) browse button will display the Soil Characteristics reference dialog box, as shown in the following figure, which lists typical saturated hydraulic conductivity values based upon soil group. Also, refer to Table 9.1, shown below, for a listing of typical hydraulic conductivity values for different soil types.

Soil Texture Class	Hydraulic Conductivity		Suction Head		Porosity (fraction)	Field Capacity (fraction)	Wilting Point (fraction)
	(in/hr)	(mm/hr)	(in)	(mm)			
Sand	4.74	120	1.93	49	0.437	0.062	0.024
Loamy Sand	1.18	30	2.40	61	0.437	0.105	0.047
Sandy Loam	0.43	11	4.33	110	0.453	0.190	0.085
Loam	0.13	3	3.50	89	0.463	0.232	0.116
Silt Loam	0.26	7	6.69	170	0.501	0.284	0.135
Sandy Clay Loam	0.06	2	8.66	220	0.398	0.244	0.136
Clay Loam	0.04	1	8.27	210	0.464	0.310	0.187
Silty Clay Loam	0.04	1	10.63	270	0.471	0.342	0.210
Sandy Clay	0.02	1	9.45	240	0.430	0.321	0.221
Silty Clay	0.02	1	11.42	290	0.479	0.371	0.251
Clay	0.01	0	12.60	320	0.475	0.378	0.265

Source: Rawls, W.J. et. al., (1983), *Journal of Hydraulic Engineering*, 109:1316.

Figure 9.31 The Soil Characteristics reference dialog box provides a listing of typical saturated hydraulic conductivity values based upon soil texture class

Table 9.1 Hydrologic Soil Group Definitions (SCS Urban Hydrology for Small Watersheds, 2nd Edition, TR-55, June 1986)

Soil Group	Description	Saturated Hydraulic Conductivity (in/hr)
A	Low runoff potential. Soils having high infiltration rates even when thoroughly wetted and consisting chiefly of deep, well to excessively drained sands or gravels.	0.30 - 0.45
B	Soils having moderate infiltration rates when thoroughly wetted and consisting chiefly of moderately deep to deep, moderately well to well-drained soils with moderately fine to moderately coarse textures. E.g., shallow loess, sandy loam.	0.15 - 0.30
C	Soils having slow infiltration rates when thoroughly wetted and consisting chiefly of soils with a layer that impedes downward movement of water, or soils with moderately fine to fine textures. E.g., clay loams, shallow sandy loam.	0.05 - 0.15
D	High runoff potential. Soils having very slow infiltration rates when thoroughly wetted and consisting chiefly of clay soils with a high swelling potential, soils with a permanent high water table, soils with a clay-pan or clay layer at or near the surface, and shallow soils over nearly impervious material.	0.00 - 0.05

Drying Time

Specifies the number of days it takes a fully saturated soil to dry. Typical values range between 2 and 14 days.

Maximum Infiltration Rate (Horton Infiltration only)

Specifies the maximum (or *initial*) infiltration rate (in/hr or mm/hr) at the start of the runoff simulation to be used in the Horton equation to compute the infiltration rate for each time step during the simulation. Singh (1992) recommends that the maximum infiltration rate be taken as roughly 5 times the minimum infiltration rate.

Clicking the browse button will display the Infiltration Rates reference dialog box, as shown in the following figure, which lists typical infiltration values based upon soil type and soil moisture. Maximum infiltration rate refers to dry soil (as compared with saturated soil).

Typical Infiltration Rates		
Surface	Infiltration	
	US Units	Metric Unit
Dry Soils (with Little or no Vegetation):		
Sandy Soils	5.00 in/hr	127 mm/hr
Loam Soils	3.00 in/hr	76 mm/hr
Clay Soils	1.00 in/hr	25 mm/hr
Dry Soils (with Dense Vegetation):		
Sandy Soils	10.00 in/hr	254 mm/hr
Loam Soils	6.00 in/hr	152 mm/hr
Clay Soils	2.00 in/hr	51 mm/hr
Moist Soils (with Little or no Vegetation, which have Drained but not Dried Out, i.e., Field Capacity):		
Sandy Soils	1.50 in/hr	38 mm/hr
Loam Soils	1.00 in/hr	25 mm/hr
Clay Soils	0.30 in/hr	8 mm/hr
Moist Soils (with Dense Vegetation, which have Drained but not Dried out, i.e., Field Capacity):		
Sandy Soils	3.50 in/hr	89 mm/hr
Loam Soils	2.00 in/hr	51 mm/hr
Clay Soils	0.70 in/hr	18 mm/hr
Moist Soils (Close to Saturation) :		
Use value close to Minimum Infiltration Rate (see below)		
Moist Soils (with Little or no Vegetation, which have Partially Dried Out, i.e., Field Capacity):		
Sandy Soils	2.00 - 3.30 in/hr	51 - 84 mm/hr
Loam Soils	1.20 - 2.00 in/hr	30 - 51 mm/hr
Clay Soils	0.40 - 0.70 in/hr	10 - 18 mm/hr
Moist Soils (with Dense Vegetation, which have Partially Dried Out, i.e., Field Capacity):		
Sandy Soils	4.00 - 6.50 in/hr	102 - 165 mm/hr
Loam Soils	2.50 - 4.00 in/hr	64 - 101 mm/hr
Clay Soils	0.80 - 1.30 in/hr	20 - 33 mm/hr

Figure 9.32 The Infiltration Rates reference dialog box provides a listing of typical infiltration values based upon soil type

Minimum Infiltration Rate (Horton Infiltration only)

Specifies the minimum (or *steady-state*) infiltration rate (in/hr or mm/hr) to be used in the Horton equation to compute the infiltration rate for each time step during the runoff simulation. The minimum infiltration rate on the Horton curve is equivalent to the soil's saturated hydraulic conductivity of the soil.

Clicking the (...) browse button will display the Infiltration Rates reference dialog box, as shown above in Figure 9.32, which lists typical infiltration values based upon soil type and soil moisture. Minimum infiltration rate refers to fully saturated soil (as compared with dry soil).

Decay Constant (Horton Infiltration only)

Specifies the infiltration rate decay constant (1/hours) to be used in the Horton equation to compute the infiltration rate for each time step during the runoff simulation. At time 0, the computed infiltration rate is equal to the defined **MAXIMUM INFILTRATION RATE**. As time progresses, the computed infiltration rate decreases until finally reaching the **MINIMUM INFILTRATION RATE**. Typical decay constants range between 2 and 7.

Maximum Volume (Horton Infiltration only)

Specifies the maximum infiltration volume possible (inches or mm, 0 if not applicable). Can be estimated as the difference between a soil's porosity and its wilting point times the depth of the infiltration zone. Clicking the (...) browse

button will display the Soil Characteristics reference dialog box, as shown above in Figure 9.31 on page 345, which lists typical soil porosity and wilting point values based upon soil group.

Suction Head (Green Ampt Infiltration only)

Specifies the average value of soil capillary suction along the wetting front (inches or mm). Clicking the browse button will display the Soil Characteristics reference dialog box, as shown above in Figure 9.31 on page 345, which lists typical suction head values.

Initial Deficit (Green Ampt Infiltration only)

Specifies the difference between soil porosity and initial moisture content (a decimal fraction). For a completely drained soil, it is the difference between the soil's porosity and its field capacity. Clicking the browse button will display the Soil Characteristics reference dialog box, as shown above in Figure 9.31 on page 345, which lists typical soil porosity and field capacity values based upon soil group.

Note that the initial deficit value may need to be reduced to account for antecedent moisture conditions due to recent rain storms. For example, to model saturated antecedent moisture conditions, an initial deficit of 0.0 should be specified.

Land Types (optional)

This entry is optional and only required for water quality simulations to compute the pollutant buildup and washoff characteristics for the subbasin.

Click the browse button to display the Pollutant Land Type Assignment dialog box, which is described in detail on page 460. From the displayed list of available land use categories, you can then specify the land use categories and corresponding percentages to be assigned to the subbasin. The percentages entered do not necessarily have to add up to 100%.

Initial Pollutants (optional)

This entry is optional and only required for water quality simulations to specify the amount of initial pollutant (sometimes called *buildup between storms*) existing over the subbasin at the start of the simulation.

Click the browse button to display the Initial Pollutants dialog box, which is described in detail on page 461.

Curb & Gutter Length (optional)

Specifies the total length of street curb and gutter in the subbasin (ft or m). This is generally two times the street length. This field is only used when pollutant buildup is normalized to curb length and water quality is being computed.

Groundwater Aquifer (optional)

This entry is optional and only required to model groundwater aquifer interaction.

Click the browse button to display the Groundwater Aquifer Assignment dialog box, which is described in detail on page 428. The Groundwater Aquifer Assignment dialog box is used to link a subbasin to both an aquifer and to a node of the drainage system that exchanges groundwater with the aquifer. The Groundwater Aquifer Assignment dialog box also specifies coefficients that determine the rate of groundwater flow between the aquifer and the node.

Snow Pack (optional)

This entry is optional and only required to model snow pack runoff. This drop-down list allows you to select an already defined snow pack that contains the data for modeling snow pack runoff. Click the browse button to display the Snow Packs dialog box, described on page 431, in order to define a new snow pack.

Internal Routing

From the drop-down list, select the method for routing runoff between pervious and impervious areas within the subbasin. The following internal routing methods are available:

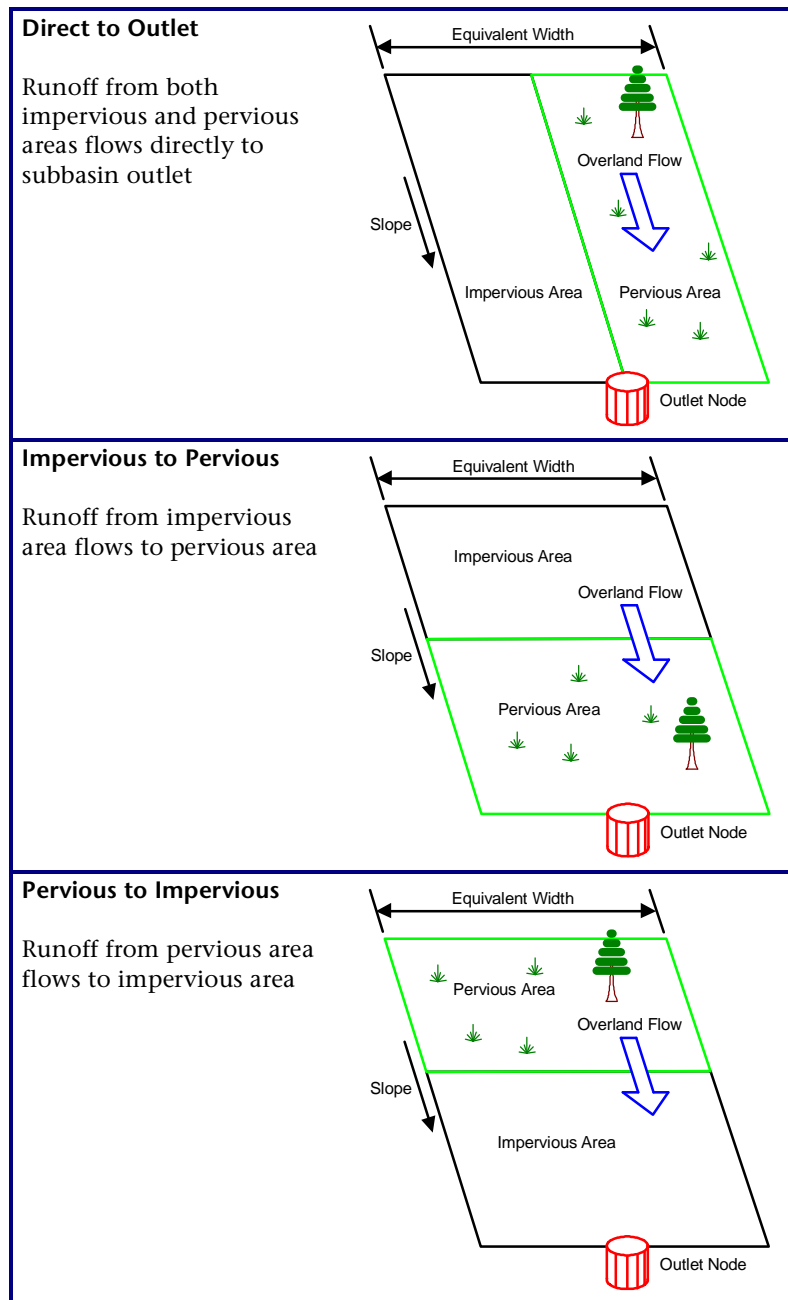

Figure 9.33 The software can account for internal routing of pervious and impervious subareas within a drainage subbasin to the subbasin outlet

Internal Runoff Routed

Specify the percent of runoff routed internally between pervious and impervious subareas (or vice versa) within the subbasin.

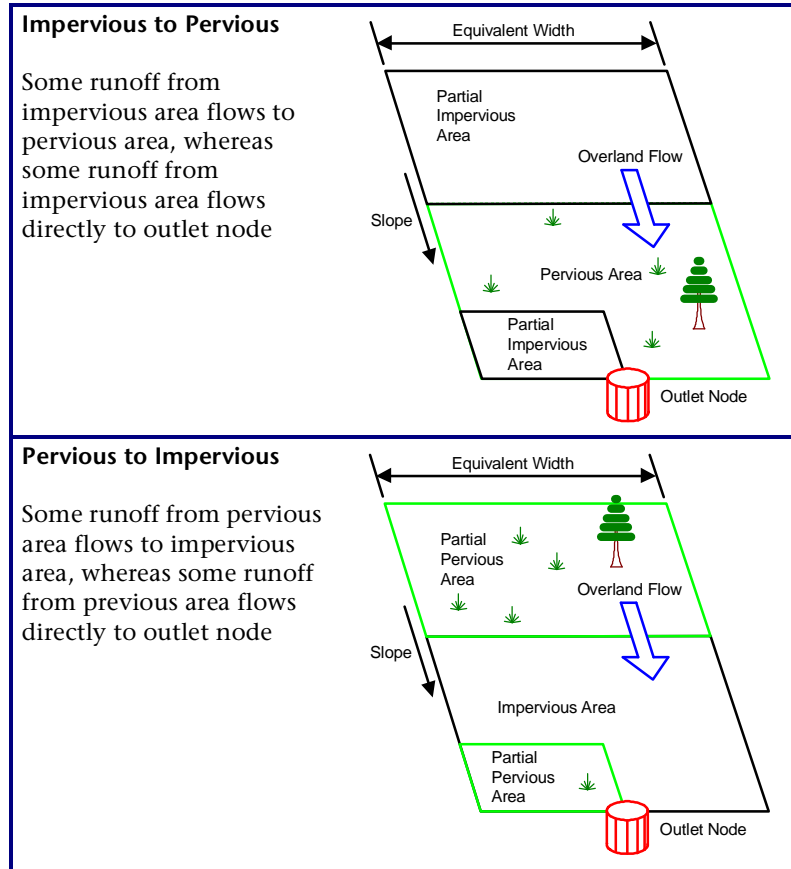

Figure 9.34 A portion of the impervious/pervious subarea can be modeled as run-on to the pervious/impervious subarea, while the remainder is directly connected to the subbasin outlet

EPA SWMM Time of Concentration Method

As shown in the following figure, the time of concentration, T_c , is generally considered the time required for rainfall runoff from the most hydraulically remote part of a drainage basin to reach the basin outlet. The definition of time of concentration is more understandable as the minimum time that must elapse for all portions of a drainage basin to contribute flow to the basin outlet due to rainfall.

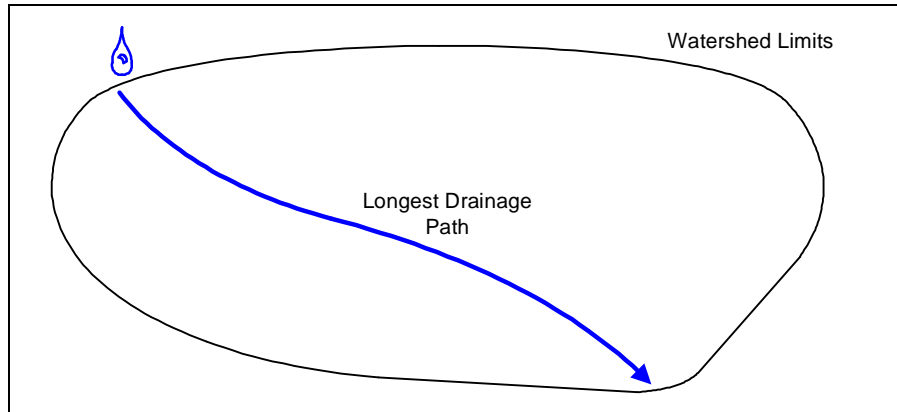

Figure 9.35 The time of concentration, T_c , is generally considered the time required for rainfall runoff from the most hydraulically remote part of a drainage basin to reach the basin outlet

While there are many methods for computing time of concentration, EPA SWMM uses the kinematic wave formulation which is dependent upon the subbasin length which is described below:

$$T_c = \left(\frac{L}{a \times i^{(m-1)}} \right)^{1/m}$$

where:

- T_c = time of concentration, seconds
- L = subbasin length, ft
- i = rainfall excess (rainfall minus losses), ft/sec
- a, m = kinematic wave parameters

Since the kinematic wave method computes the time of concentration using excess rainfall (rainfall less infiltration), this method is dependent upon the rainfall intensity. As intensity increases, T_c then decreases. In addition, time of concentration is dependent upon subbasin length.

EPA SWMM computes the time of concentration accounting for both pervious and impervious subareas. In its computations, it will account for the specified portion of the impervious (or pervious) subarea that may be directly connected to the subbasin outlet and the remaining portion modeled as run-on to the pervious (or impervious) subarea. The computed time of concentration for each subbasin is reported in the analysis output report.

In computing the time of concentration for a subbasin, note that the width and slope are the same for both pervious and impervious areas. Manning's roughness and relative area are the only parameters available to you to characterize the relative contributions of pervious and impervious areas to the outlet hydrograph.

In EPA SWMM hydrology, overland flow is idealized as running down-slope off an rectangular area, as shown in the following figure, corresponding to current subbasin.

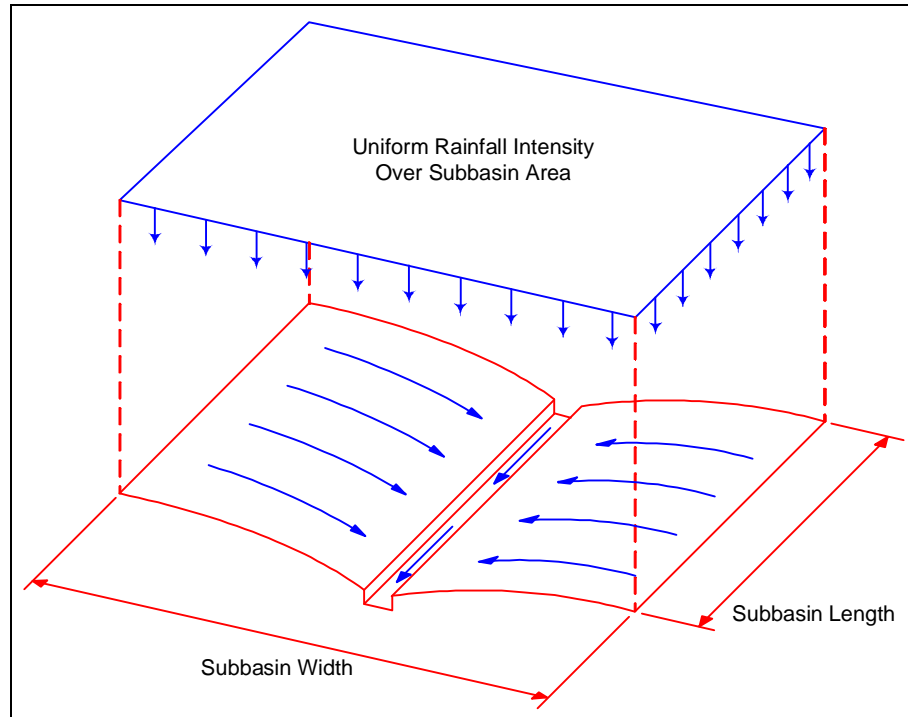

Figure 9.36 The Kinematic Wave time of concentration method, used within the EPA SWMM hydrology method, is idealized over a rectangular area representing the subbasin

EPA SWMM Hydrology

Subbasins can be divided into pervious and impervious subareas. Surface runoff can infiltrate into the upper soil zone of the pervious subarea, but not through the impervious subarea. Impervious areas are themselves divided into two subareas—one that contains depression storage and another that does not. Runoff flow from one subarea in a subbasin can be routed to the other subarea, or both subareas can drain to the subbasin outlet directly.

Infiltration of rainfall from the pervious area of a subbasin into the unsaturated upper soil zone can be described using one of three infiltration methods (selected in Project Options dialog box, General tab, see page 163):

- SCS Curve Number infiltration
- Horton infiltration
- Green-Ampt infiltration

To model the accumulation, redistribution, and melting of precipitation that falls as snow on a subbasin, a subbasin must be assigned a snow pack. To model groundwater flow between an aquifer underneath the subbasin and a node of the drainage system, the subbasin must be assigned to a groundwater aquifer. To model pollutant buildup and washoff in a subbasin, land types must be defined for the subbasin.

The conceptual view of surface runoff used by EPA SWMM is illustrated in the following figure. Subbasin areas are handled as nonlinear reservoirs. Inflow comes from precipitation and any designated upstream subbasins. Outflow can include infiltration, evaporation, and surface runoff. The storage capacity of a subbasin area is the maximum depression storage (the maximum surface storage provided by ponding, surface wetting, and interception). Surface runoff per unit area, Q ,

occurs only when the depth of water in the reservoir exceeds the maximum depression storage, d_p , in which case the outflow is provided by Manning's equation. Depth of water in the subbasin, d , is continuously updated with time (t in seconds) by solving a water balance equation for the subbasin.

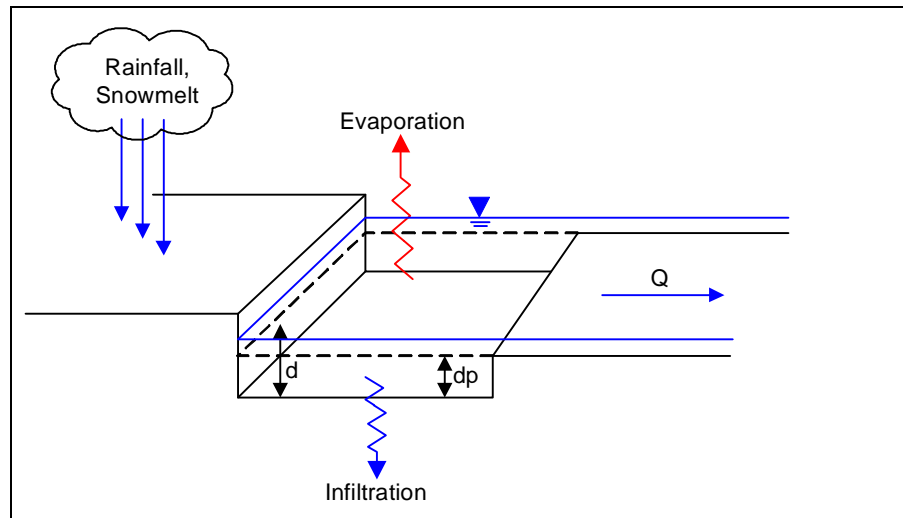

Figure 9.37 The conceptual view of EPA SWMM surface runoff hydrology

Note that the infiltration calculations apply only to the pervious portion of the defined subbasin area. The impervious portion of the subbasin area is assumed to translate entirely into runoff, less any initial abstraction due to specified depression depth for the impervious area as shown in the following figure. Therefore, any infiltration parameters, such as a composite curve number value, should be specified for the pervious portion of the subbasin. Impervious areas should be specified directly using the percent impervious parameter, and not be included in the composite curve number. In fact, defining a composite curve number that includes the impervious area and also defining the percentage impervious area will double count the effect of the impervious area.

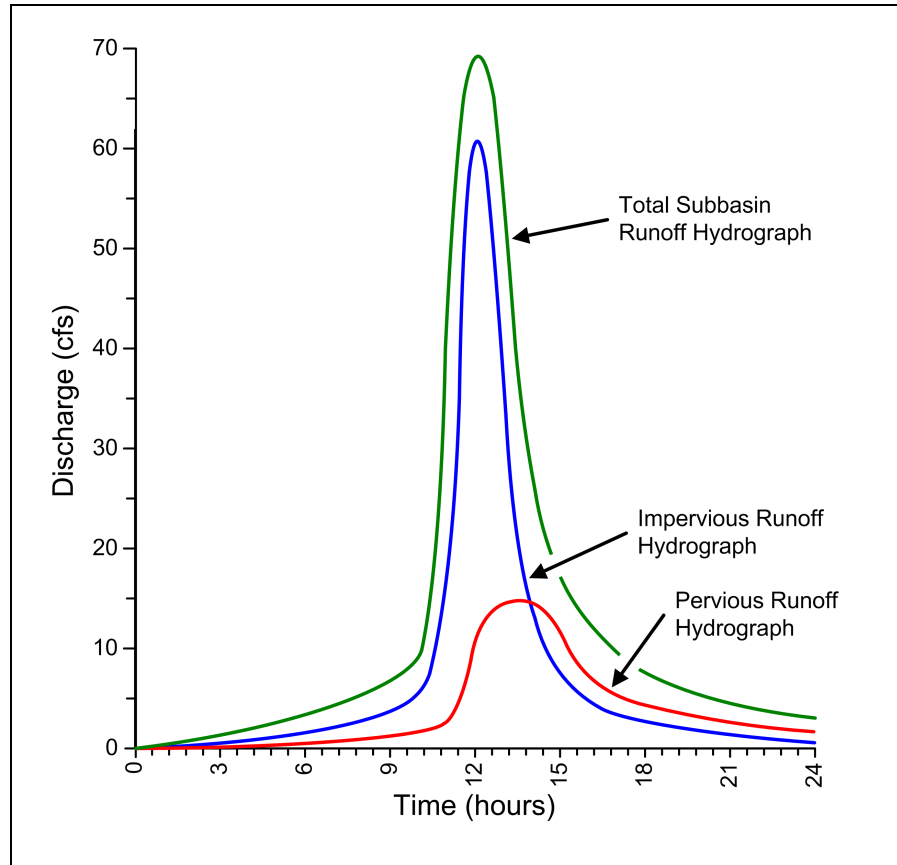

Figure 9.38 Breakdown of pervious, impervious, and total runoff from a single subbasin using EPA SWMM runoff hydrology

Furthermore, the urban runoff computational capabilities of SWMM will be lost if a composite curve number is used to account for impervious areas, rather than specifying the percent impervious area directly. This is because SWMM will not be able to realistically account for the dynamic response of the runoff process that occurs in urban areas where impervious areas generally govern the peak flows and, often, runoff volumes.

HEC-1 Hydrology Method

The HEC-1 hydrology method is limited to a single storm event since there is no provision to account for soil moisture recovery during periods of no precipitation. Precipitation excess is computed by subtracting infiltration and detention losses based on a soil water infiltration rate function. Rainfall and infiltration are assumed to be uniform over the subbasin. The resulting rainfall excesses are then routed to the subbasin outlet by the unit hydrograph or kinematic wave techniques, producing a runoff hydrograph.

If the unit hydrograph technique is used, the precipitation loss is considered to be uniformly distributed over the entire subbasin. If the kinematic wave technique is used, separate precipitation losses can be specified for each overland flow plane (if two are used). The losses are assumed to be uniformly distributed over each overland flow plane.

In some instances, there may be negligible precipitation losses for a portion of a subbasin. Examples of this could be an area containing a lake, reservoir, or impervious pavement. In these examples, precipitation losses will not be

computed for a specified percentage of the area labeled as impervious. The available Unit Hydrograph and Loss Methods for HEC-1 are defined in the Project Options dialog box, General tab, as described on page 163.

Physical Properties Tab

The Physical Properties tab defines general data used in computing the HEC-1 runoff, as shown in the following figure.

Section	Parameter	Value	Units
Basin data	Area	5,280	ac
	Initial base flow	0	cfs
	Recession base flow	0	cfs
	Recession constant	0	
Analysis summary	Peak runoff	12.195	cfs
	Total runoff	1.938	in

Figure 9.39 The Physical Properties tab defines general data for computing the HEC-1 runoff

Area

Specify the drainage area (acres/ft² or hectares/m²) for the subbasin being defined. Note that the drainage units (acres/ft² or hectares/m²) is defined by the entry **SUBBASIN AREA UNITS** in the Project Options dialog box, Elements Prototype tab, described on page 183.

Note that the drainage area is automatically determined as you digitize it on the Plan View. However, you can over-ride this area by entering a different value in this field. If you want to have the software recompute all of the drainage areas based upon what is currently digitized in the Plan View, select **DESIGN ► RECOMPUTE AREAS**.

Base Flow

In addition to direct runoff from precipitation, additional runoff can be contributed from base flow from the release of water from subsurface storage. The HEC-1 hydrology method can account for the contribution of base flow from subsurface storage, as shown in the following figure.

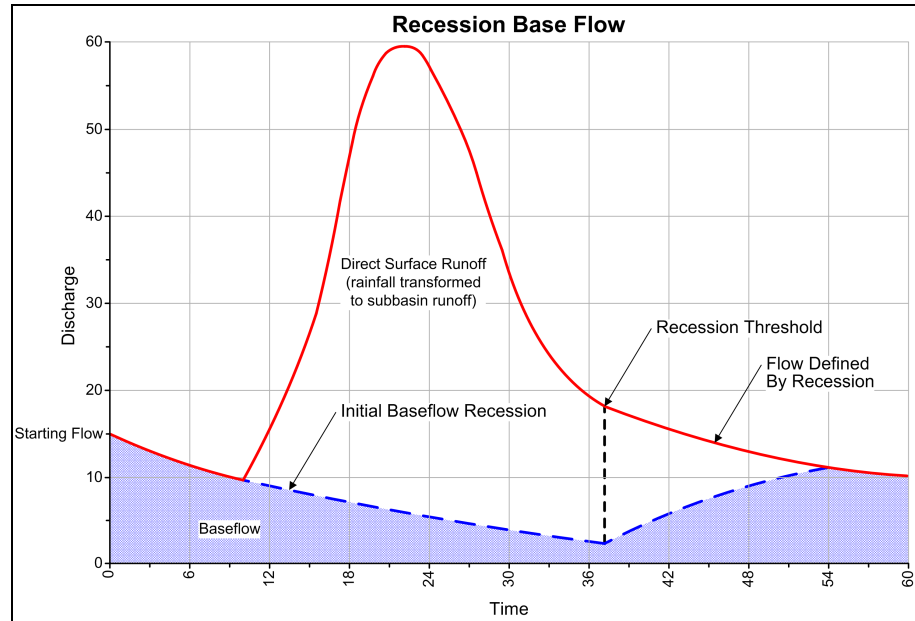

Figure 9.40 Base flow diagram, showing how HEC-1 can account for runoff from direct runoff and base flow from subsurface storage

HEC-1 uses an exponential recession model to represent watershed baseflow (Chow, Maidment, and Mays, 1988). The recession model has been used often to explain the drainage from natural storage in a watershed (Linsley et al, 1982). It defines the relationship of Q_t , the baseflow at any time t , to an initial value as:

$$Q_t = Q_0 k^t$$

where:

- Q_0 = initial baseflow (at time zero)
- t = time in hours since the recession was initiated
- k = recession constant

The baseflow that is then computed is illustrated above in Figure 9.40. The shaded region represents baseflow; the contribution decays exponentially from the starting flow. Total flow is the sum of the baseflow and the direct surface runoff.

As implemented in HEC-1, k is defined as the ratio of the baseflow at time t to the baseflow one day earlier. The starting baseflow value, Q_0 , is an initial condition of the model.

In HEC-1, the baseflow model is applied both at the start of simulation of a storm event, and later in the event as the delayed subsurface flow reaches the watershed channels, as illustrated above in Figure 9.40. Here, after the peak of the direct runoff, a user-specified threshold flow defines the time at which the recession model shown in the previous equation defines the total flow. That threshold may be specified as a flow rate or as a ratio to the computed peak flow. For example, if the threshold is specified as a ratio-to-peak of 0.10, and the computed peak is 1000 cfs, then the threshold flow is 100 cfs. Subsequent total flows are computed with the above equation, with Q_0 as the specified threshold value.

The rising limb of the streamflow hydrograph is adjusted for base flow by adding the recessed starting flow to the computed direct runoff flows. The falling limb of the streamflow hydrograph is determined in the same manner until the computed flow is determined to be less than the recession base flow. At this point, the time at which the recession base flow is reached is estimated from the computed hydrograph. From this time on, the streamflow hydrograph is computed using the recession equation unless the computed flow rises above the base flow recession. This is the case of a double peaked streamflow hydrograph where a rising limb of the second peak is computed by combining the starting flow recessed from the beginning of the simulation and the direct runoff.

The recession base flow and the recession constant can be obtained by plotting the log of observed flows versus time. The point at which the recession limb fits a straight line defines the recession base flow and the slope of the straight line represents the recession constant. The point along the straight line plot (on semilog paper) where the recession line deviates from the falling limb of the hydrograph represents the recession base flow.

At the threshold flow, baseflow is defined by the initial baseflow recession. Thereafter, baseflow is not computed directly, but is defined as the recession flow less the direct surface runoff. When the direct surface runoff eventually reaches zero (all rainfall has run off the subbasin), the total flow and baseflow are identical.

After the threshold flow occurs, the streamflow hydrograph ordinates are defined by the recession model alone, unless the direct runoff plus initial baseflow recession contribution exceeds the threshold. This may be the case if subsequent precipitation causes a second rise in the hydrograph, as illustrated in the following figure. In that case, ordinates on the second rising limb are computed by adding direct runoff to the initial recession, as illustrated.

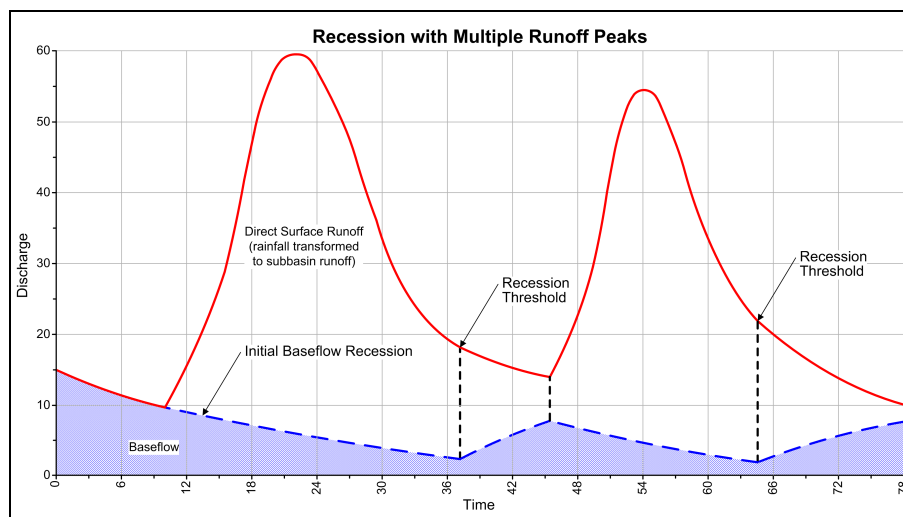

Figure 9.41 Base flow diagram, showing multiple runoff peaks due to subsequent precipitation

The following parameters define the data necessary for computing the contributing base flow.

Base Flow

This check box allows you to disable/enable base flow from subsurface storage. When this check box is disabled, the following fields are grayed out (not available).

Initial Base Flow

This field represents the initial flow in a river or stream (in cfs or cms). It is affected by the long term contribution of groundwater releases in the absence of precipitation and is a function of antecedent conditions (i.e., the time between the storm being modeled and the last occurrence of precipitation).

For analysis of hypothetical storm runoff, initial flow should be selected as a likely average flow that would occur at the start of the storm runoff. For frequent events, the initial flow might be the average annual flow in the channel. A field inspection may help establish this. As with the constant, monthly-varying baseflow, for most urban channels and for smaller streams in the western and southwestern USA this value may well be zero, as the baseflow contribution is negligible.

If this value is entered as a negative value, then it represents the cfs/mi² (or cms/km²) that will be multiplied by the basin area to determine the initial base flow.

Recession Base Flow

This field represents the flow in cfs (or cms) below which base flow recession occurs in accordance with the recession constant.

If this value is entered as a negative value, then it represents the ratio by which the peak discharge is multiplied to determine the recession base flow. For example, enter a value of -0.1 to specify that the exponential recession is to begin when the falling limb discharge drops to 0.1 of the calculated peak discharge.

Recession Constant

Recession of the initial base flow and the falling limb follow an exponential decay rate (recession constant) which is assumed to be a characteristic of the basin. This field represents the ratio of recession flow to that flow occurring one hour later. This value must be greater or equal to one.

The recession constant depends upon the source of baseflow. If the recession constant = 1.00, the baseflow contribution will be constant, with all $Q_t = Q_0$. Otherwise to model the exponential decay typical of natural undeveloped watersheds, the recession constant must be greater than 1.00. Table 9.2 below shows typical values proposed by Pilgrim and Cordery (1992) for basins ranging in size from 300 to 16,000 km² (120 to 6,500 square miles) in the USA, eastern Australia, and several other regions. Large watersheds generally have recession constant values at the lower end of the range, while smaller watersheds will have values at the upper end.

Table 9.2 Typical recession constant values (Pilgrim and Cordery 1992)

Flow Component	Recession Constant
Groundwater	1.05
Interflow	1.05 - 1.25
Surface runoff	1.25 - 3.30

The recession constant can be estimated if gaged flow data are available. Flows prior to the start of direct runoff can be plotted, and an average of ratios of ordinates spaced one day apart can be computed. This is simplified if a logarithmic axis is used to plot the flows, as the recession model will plot as a straight line.

The threshold value can be estimated also from an examination of a graph of observed flows versus time. The flow at which the recession limb is approximated by a straight line defines the threshold value.

Uniform Loss Method

The Uniform Loss Method is the default loss method for HEC-1. The Uniform Loss Method is simple in concept, but is generally appropriate for watersheds that lack detailed soil infiltration information. For this method, an initial loss and a constant loss rate are specified.

The initial loss specifies the amount of initial precipitation that will be infiltrated (or stored) in the subbasin before surface runoff begins. All initial rainfall is lost until the specified initial loss volume is satisfied. There is no recovery of the initial loss during later time periods.

The constant rate specifies the rate of infiltration that will occur after the initial loss is satisfied. After the initial loss is satisfied, rainfall is lost at the specified constant loss rate. The same rate is applied regardless of the length of the precipitation event.

When using the Kinematic Wave Method for modeling the subbasin runoff response, the Uniform Loss Method is defined in the Overland Flow Runoff tab as shown below in Figure 9.42. (For the Kinematic Wave Method, there is an option to have the subbasin broken into two separate subareas. Hence, there are two subarea columns provided. Two subareas are typically used to describe the pervious and impervious portions of a subbasin.)

For all other synthetic unit hydrograph methods, the Uniform Loss Method is defined in the Loss & UH Parameters tab as shown below in Figure 9.43.

The screenshot shows a software window with four tabs: 'Physical Properties', 'Subarea Properties', 'Overland Flow Runoff', and 'Channelized Runoff'. The 'Overland Flow Runoff' tab is active. Inside this tab, there is a section titled 'Uniform loss parameters' which is divided into two columns: 'Subarea A' and 'Subarea B'. Each column contains three input fields: 'Initial loss:' with a value of 1.0 and unit 'in'; 'Uniform loss:' with a value of 0.1 and unit 'in/hr'; and 'Impervious area:' with a value of 25 and a dropdown arrow. At the bottom of the window, there are labels for 'Subbasin ID', 'Area', and 'Gage'.

Figure 9.42 When using the Kinematic Wave Method for modeling the subbasin runoff response, then the Uniform Loss Method is defined in the Overland Flow Runoff tab

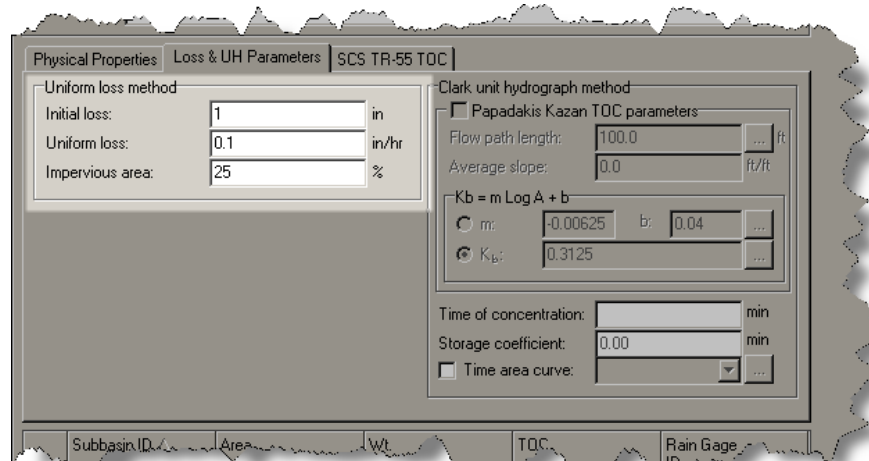

Figure 9.43 For all other synthetic unit hydrograph methods, the Uniform Loss Method is defined in the Loss & UH Parameters tab

Initial Loss

This field defines the initial loss (or initial abstraction) of precipitation (in inches or mm) that does not get transformed into subbasin runoff. All precipitation is lost until the volume of initial loss is satisfied.

Uniform Loss

This field defines a uniform or constant loss rate (in inches/hr or mm/hr). After the initial loss has been satisfied, precipitation is lost at this specified rate.

Impervious Area

Specify the percentage of subbasin area that is impervious (i.e., roofs, asphalt or concrete roadways and sidewalks, etc.).

SCS Curve Number Loss Method

The SCS Curve Number Loss Method is a commonly used loss method for HEC-1. The SCS Curve Number Loss Method is adapted from the NRCS (SCS) Curve Number method for estimating runoff. It assumes that the total infiltration capacity of a soil can be found from the soil's tabulated Curve Number. During a rain event, this capacity is depleted as a function of cumulative rainfall and remaining capacity. The input parameters for this method are the curve number, the soil's hydraulic conductivity (used to estimate a minimum separation time for distinct rain events), and a time it takes a fully saturated soil to completely dry. For more background information regarding this method, see page 169.

When using the Kinematic Wave Method for modeling the subbasin runoff response, then the SCS Curve Number Loss Method is defined in the Overland Flow Runoff tab as shown below in Figure 9.44. (For the Kinematic Wave Method, there is an option to have the subbasin broken into two separate subareas. Hence, there are two subarea columns provided. Two subareas are typically used to describe the pervious and impervious portions of a subbasin.)

For all other synthetic unit hydrograph methods, the SCS Curve Number Loss Method is defined in the Loss & UH Parameters tab as shown below in Figure 9.45.

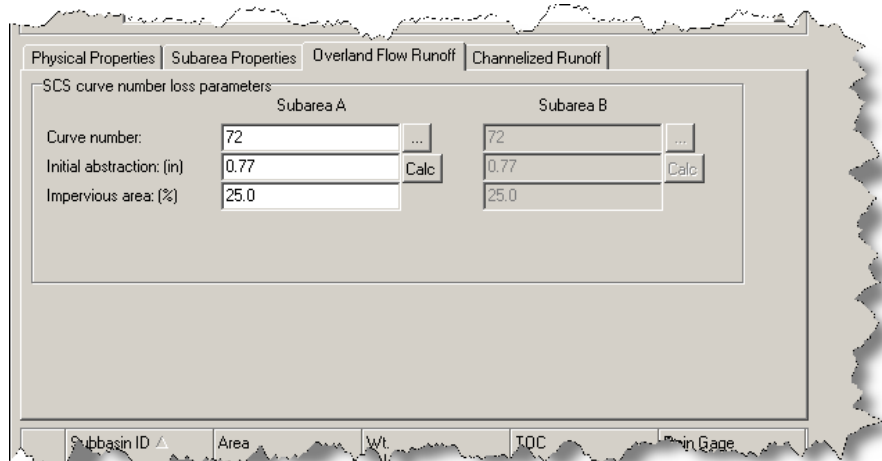

Figure 9.44 When using the Kinematic Wave Method for modeling the subbasin runoff response, then the SCS Curve Number Loss Method is defined in the Overland Flow Runoff tab

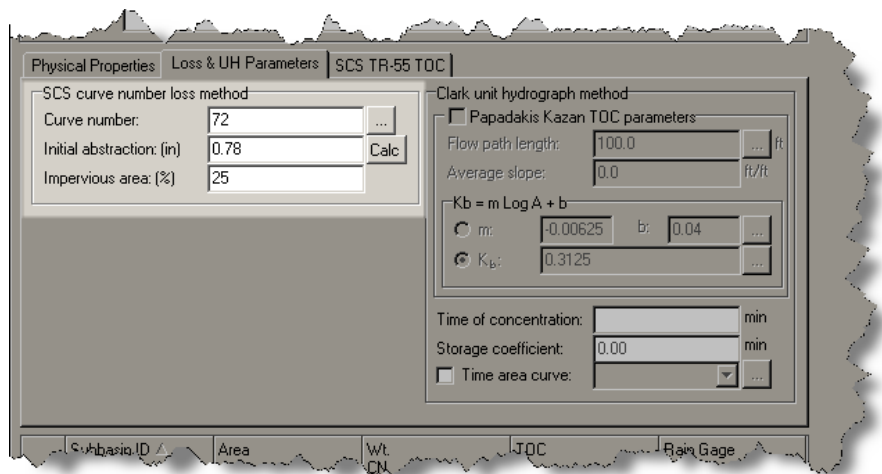

Figure 9.45 For all other synthetic unit hydrograph methods, the SCS Curve Number Loss Method is defined in the Loss & UH Parameters tab

Curve Number

This field is read-only, and represents the composite SCS curve number that was computed from the Curve Number tab. Click the (...) browse button to display a summary report on the composite curve number computations, as shown in the following figure.

Soil/Surface Description	Area (acres)	Soil Group	CN
> 75% grass cover, Good	2.00	C	74.00
Small grain, C&T + CR, Good	3.00	D	80.00
Composite Area & Weighted CN	5.00		77.60

Figure 9.46 The summary report showing the composite curve number computations for the current subbasin

The curve number is based on the drainage area's hydrologic soil group, land use, and hydrologic condition. A high CN value (as high as 98 for paved roadways, roofs, and other impervious surfaces) causes nearly all of the precipitation to translate into runoff, where as a low CN value (as low as 30 for some conditions) causes most of the precipitation to be captured as infiltration and not translate into runoff. Further information on curve numbers is detailed in the section titled *SCS TR-55 Curve Numbers* on page 328.

Initial Abstraction

Precipitation loss is calculated based on the defined curve number and initial abstraction value, where the initial abstraction is an initial surface moisture storage capacity in units of depth (inches or mm). Clicking the Calc button will cause the software to compute the initial abstraction value based upon the defined curve number, using the following relationship:

$$S = \frac{1000 - 10 \times CN}{CN}$$

$$IA = 0.2 \times S$$

where:

- S = potential maximum retention after runoff begins (inches)
- CN = curve number
- IA = initial abstraction (inches)

Impervious Area

Specify the percentage of subbasin area that is impervious (i.e., roofs, asphalt or concrete roadways and sidewalks, etc.).

Exponential Loss Method

The Exponential Loss Method is empirical and typically should not be used without calibration. It represents incremental infiltration as logarithmically decreasing with accumulated infiltration. It includes the option for increased initial infiltration when the soil is particularly dry before the arrival of a storm. Because it is a function of cumulative infiltration and does not include any type of recovery, it should not be used for continuous simulation studies.

When using the Kinematic Wave Method for modeling the subbasin runoff response, then the Exponential Loss Method is defined in the Overland Flow

Runoff tab as shown below in Figure 9.47. (For the Kinematic Wave Method, there is an option to have the subbasin broken into two separate subareas. Hence, there are two subarea columns provided. Two subareas are typically used to describe the pervious and impervious portions of a subbasin.)

For all other synthetic unit hydrograph methods, the Exponential Loss Method is defined in the Loss & UH Parameters tab as shown below in Figure 9.48.

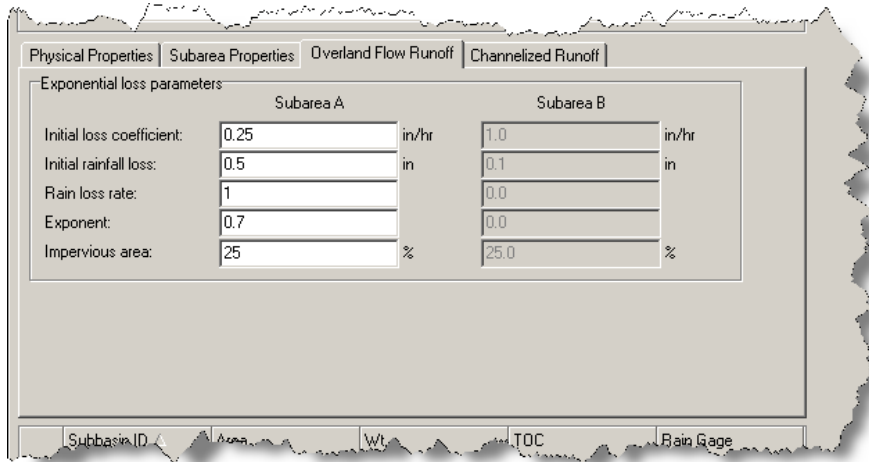

Figure 9.47 When using the Kinematic Wave Method for modeling the subbasin runoff response, then the Exponential Loss Method is defined in the Overland Flow Runoff tab

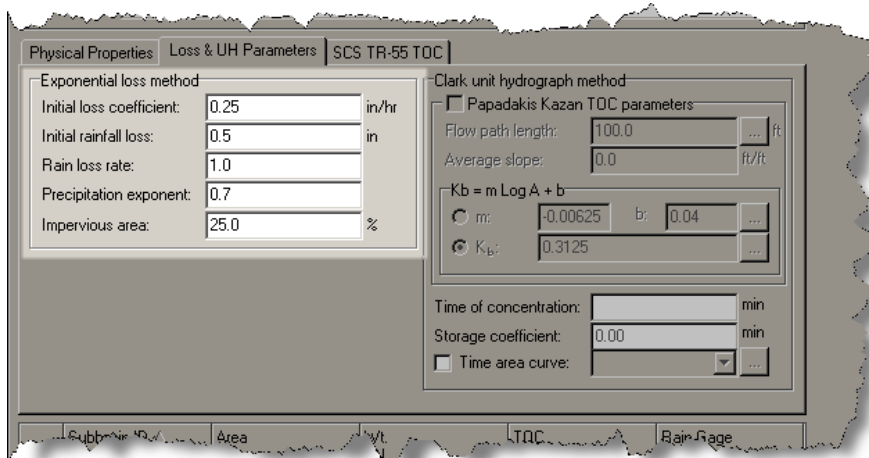

Figure 9.48 For all other synthetic unit hydrograph methods, the Exponential Loss Method is defined in the Loss & UH Parameters tab

Initial Loss Coefficient

This field defines the initial value for the HEC-1 exponential rain loss rate function for snow-free ground (in inches/hr or mm/hr). The starting value is considered a function of infiltration capacity and depends on such basin characteristics as soil type, land use, and vegetation cover.

Initial Rainfall Loss

This field defines the amount of initial rain loss during which the loss rate coefficient is increased (in inches or mm). This parameter is considered to be a function primarily of antecedent soil moisture deficiency and is usually storm dependent.

Rain Loss Rate

This field defines the ratio of rain loss coefficient on the exponential loss curve to that corresponding to 10 inches (10 mm) of accumulated loss. This variable may be considered a function of the ability of the basin surface to absorb precipitation and should be reasonably constant for large homogeneous areas.

Precipitation Exponent

This field defines the exponent of precipitation for the loss rate function.

Impervious Area

Specify the percentage of subbasin area that is impervious (i.e., roofs, asphalt or concrete roadways and sidewalks, etc.).

Under certain circumstances it may be more convenient to work with the exponential loss rate as a two parameter infiltration model. To obtain an initial and constant loss rate function, set the Precipitation Exponent = 0.0 and the Rain Loss Rate = 1.0. To obtain a loss rate function that decays exponentially with no initial loss, set the Precipitation Exponent = 0.0 and the Initial Rainfall Loss = 0.0.

Green Ampt Loss Method

The Green Ampt Loss Method assumes the soil is initially at a uniform moisture content, and infiltration takes place through a sharp wetting front. This wetting front exists in the soil column, separating the soil with an initial moisture content below from the saturated soil above, as shown in the following figure. This method automatically accounts for ponding on the surface.

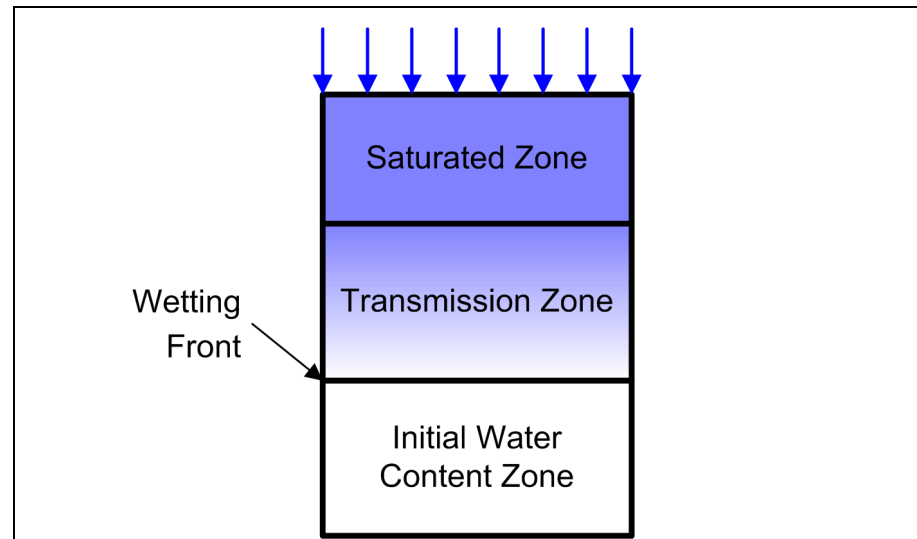

Figure 9.49 Illustration of the Green Ampt method, showing the upper saturated zone, transmission zone, wetting front, and soil with the initial moisture content

The key advantages and limitations of the Green Ampt loss method include:

- The parameters of the Green Ampt loss method can be related to soil properties that can be measured in the laboratory, such as porosity and hydraulic conductivity.
- The Green Ampt loss method assumes an overland flow type mechanism which is not entirely appropriate for forested areas where a subsurface mechanism tends to control direct runoff.

When using the Kinematic Wave Method for modeling the subbasin runoff response, the Green Ampt Loss Method is defined in the Overland Flow Runoff tab as shown below in Figure 9.50. (For the Kinematic Wave Method, there is an option to have the subbasin broken into two separate subareas. Hence, there are two subarea columns provided. Two subareas are typically used to describe the pervious and impervious portions of a subbasin.)

For all other synthetic unit hydrograph methods, the Green Ampt Loss Method is defined in the Loss & UH Parameters tab as shown below in Figure 9.51.

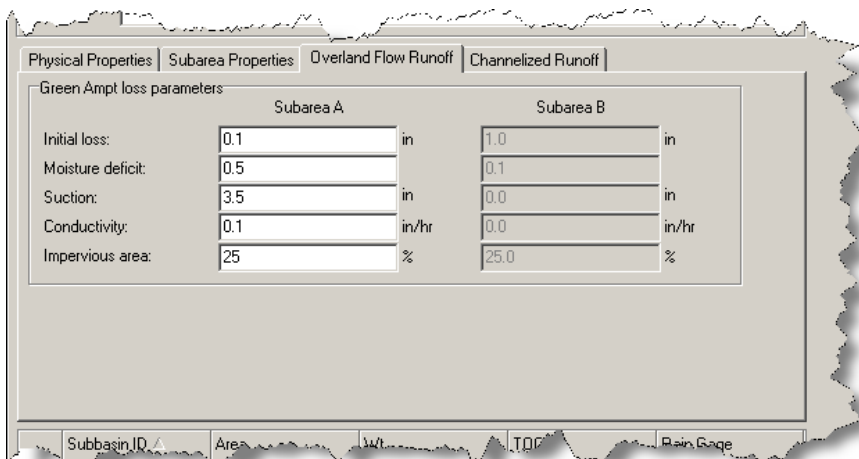

Figure 9.50 When using the Kinematic Wave Method for modeling the subbasin runoff response, the Green Ampt Loss Method is defined in the Overland Flow Runoff tab

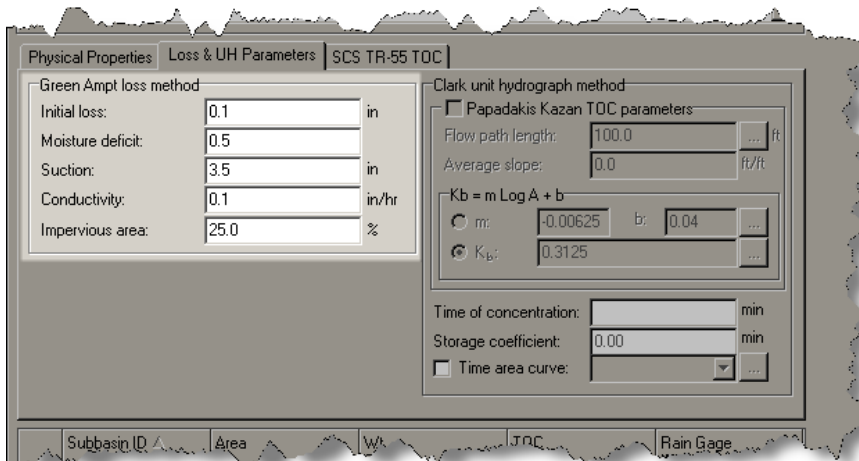

Figure 9.51 For all other synthetic unit hydrograph methods, the Green Ampt Loss Method is defined in the Loss & UH Parameters tab

Initial Loss

This field defines the initial loss (or initial abstraction) of precipitation (in inches or mm) that does not get transformed into subbasin runoff. All precipitation is lost until the volume of initial loss is satisfied.

Initial Deficit

Specifies the difference between soil porosity and initial moisture content (a decimal fraction). For a completely drained soil, it is the difference between the soil's porosity and its field capacity. Clicking the (...) browse button will

display the Soil Characteristics reference dialog box, as shown above in Figure 9.31 on page 345, which lists typical soil porosity and field capacity values based upon soil group.

Note that the initial deficit value may need to be reduced to account for antecedent moisture conditions due to recent rain storms. For example, to model saturated antecedent moisture conditions, an initial deficit of 0.0 should be specified.

Suction Head

Specifies the average value of soil capillary suction along the wetting front (inches or mm). Clicking the (...) browse button will display the Soil Characteristics reference dialog box, as shown above in Figure 9.31 on page 345, which lists typical suction head values.

Conductivity

This value denotes the soil's saturated hydraulic conductivity (in/hr or mm/hr). Clicking the (...) browse button will display the Soil Characteristics reference dialog box, as shown above in Figure 9.31 on page 345, which lists typical saturated hydraulic conductivity values based upon soil group. Also, refer to Table 9.1 on page 346, for a listing of typical hydraulic conductivity values for different soil types.

Impervious Area

Specify the percentage of subbasin area that is impervious (i.e., roofs, asphalt or concrete roadways and sidewalks, etc.).

Holtan Loss Method

The Holtan Loss Method was developed for agricultural watersheds. Infiltration is treated as a function of crop maturity, surface connected porosity, available storage in the surface layer, and soil infiltration rate.

When using the Kinematic Wave Method for modeling the subbasin runoff response, then the Holtan Loss Method is defined in the Overland Flow Runoff tab as shown below in Figure 9.50. (For the Kinematic Wave Method, there is an option to have the subbasin broken into two separate subareas. Hence, there are two subarea columns provided. Two subareas are typically used to describe the pervious and impervious portions of a subbasin.)

For all other synthetic unit hydrograph methods, the Holtan Loss Method is defined in the Loss & UH Parameters tab as shown below in Figure 9.51.

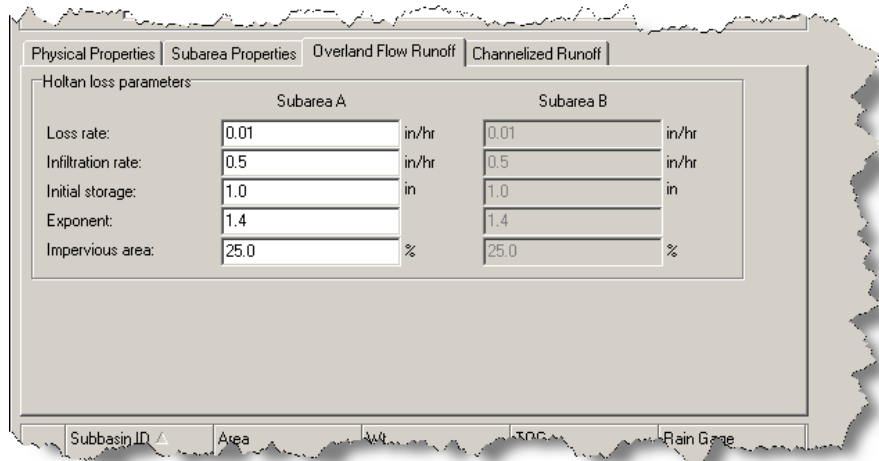

Figure 9.52 When using the Kinematic Wave Method for modeling the subbasin runoff response, then the Holtan Loss Method is defined in the Overland Flow Runoff tab

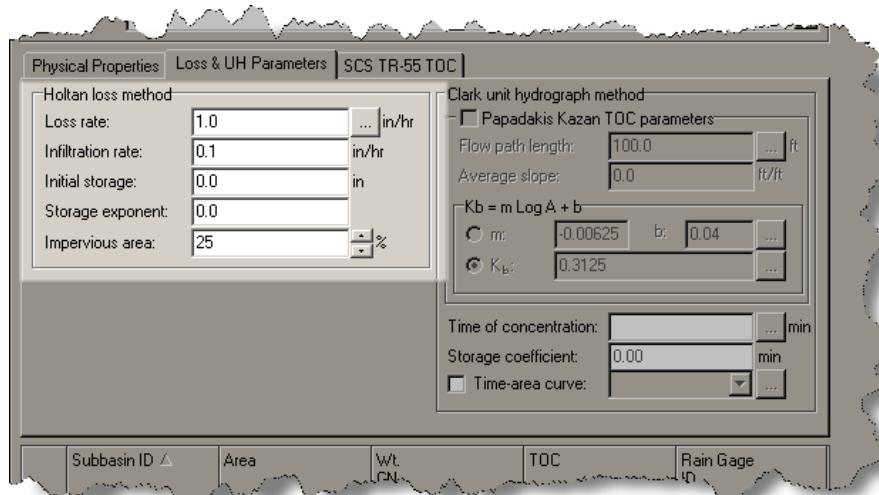

Figure 9.53 For all other synthetic unit hydrograph methods, the Holtan Loss Method is defined in the Loss & UH Parameters tab

Loss Rate

This field defines the Holtan long-term equilibrium loss rate (in inches/hr or mm/hr) for rainfall losses on snow-free ground, representing the constant rate of percolation of water through the soil profile below the surface layer.

Clicking the [...] browse button will display the Holtan Equilibrium Loss Rate reference dialog box, as shown in the following figure, which lists loss rates based upon hydrologic soil groups.

Holton Equilibrium Loss Rate	
Soil Group	Loss Rate
A	0.30 - 0.45
B	0.15 - 0.30
C	0.05 - 0.15
D	0.05 or less

Source: USACE, 1998, HEC-1 Flood Hydrograph Package User's Manual, Hydrologic Engineering Center, Davis, CA

Figure 9.54 The Holton Equilibrium Loss Rate reference dialog box based upon hydrologic soil groups

Infiltration Rate

This field represents the product of a “growth index” representing the relative maturity of the ground cover and the infiltration capacity.

Initial Storage

This field represents the initial value and upper limit of equivalent depth in inches (mm) or pore space in the surface layer of the soil which is available for storage of infiltrated water. The defined loss rate cannot cause the soil moisture capacity to grow above this value.

Storage Exponent

This value denotes an empirical exponent of available soil moisture storage, typically taken as 1.4.

Impervious Area

Specify the percentage of subbasin area that is impervious (i.e., roofs, asphalt or concrete roadways and sidewalks, etc.).

Clark Unit Hydrograph Method

The Clark unit hydrograph method is the default unit hydrograph method for HEC-1. The Clark unit hydrograph method is a synthetic unit hydrograph method. That is, you are not required to develop a unit hydrograph through the analysis of past observed hydrographs.

The Clark unit hydrograph method derives a watershed unit hydrograph by explicitly representing two critical processes in the transformation of excess precipitation to runoff:

- Translation or movement of the excess from its origin throughout the drainage to the watershed outlet.
- Attenuation or reduction of the magnitude of the discharge as the excess is stored throughout the watershed.

The Clark Unit Hydrograph procedure was developed from observed data that included both urban and natural (undeveloped) desert/rangeland watersheds. Its primary application is for urban watersheds, but is applicable to desert/rangeland watersheds also. In general, it should not be applied to agricultural fields or steep mountain watersheds.

The recommended maximum size limitation for a subbasin using the Clark Unit Hydrograph Method is 5 mi², with an absolute upper limit of 10 mi². In addition,

the computed time of concentration should not exceed the duration of rainfall excess. For example, if a 4 mi² subbasin is being analyzed for which the duration of rainfall excess is calculated to be 1 hr and the T_c is calculated as 1.5 hr, then the Clark UH method should not be used. In this situation, you have two options to choose from:

- Subdivide the subbasin into two or more smaller subbasins so that none of the T_c's exceed the duration of rainfall excess.
- Use a different unit hydrograph method.

The Loss & UH Parameters tab for the Clark Unit Hydrograph Method is shown in the following figure.

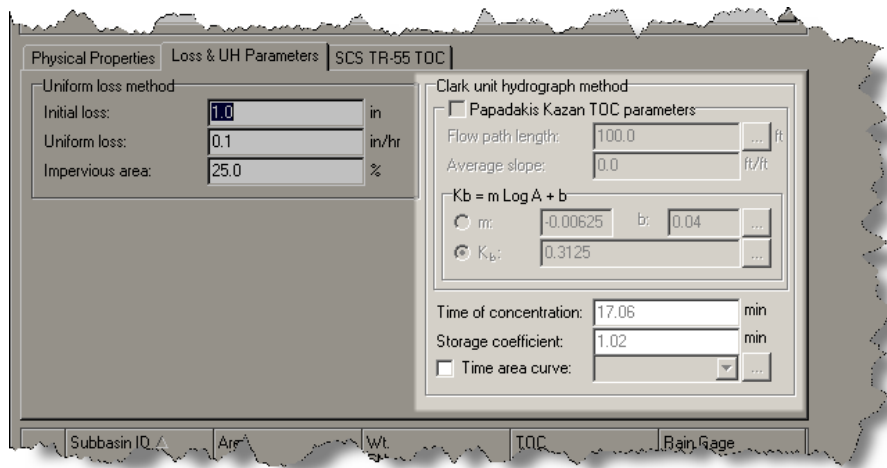

Figure 9.55 The Loss & UH Parameters tab for the Clark Unit Hydrograph Method

Papadakis Kazan TOC Parameters

This check box allows you to disable/enable Papadakis Kazan TOC section. This method is used in Maricopa & Pima Counties, AZ. When this check box is disabled, the Papadakis Kazan TOC Parameter fields are grayed out (not available).

Flow Path Length

This field represents the travel distance required for runoff to travel from the hydraulically most distant point of the subbasin to where the runoff leaves the subbasin (concentration point). Tillage can affect the direction of the flow path; flow may not always be directly down the watershed slope if tillage runs across the slope. For an urban subbasin where flow is mainly in streets and no primary channels exist, an average flow path should be selected—such as a line parallel to grade from the subbasin outlet to the watershed's upper boundary.

Average Slope

This field represents the average slope of the flow path. The slope can be calculated as the difference in elevation between the two points used to define the flow path length, divided by the flow path length. Subbasins in mountains can result in large values for slope, which may result in an underestimation of T_c. This is because as slope increases in natural watersheds, the runoff velocity does not usually increase in a corresponding manner. The slope of steep natural watercourses is often adjusted to reduce the slope, and the reduced slope is used in calculating runoff travel times. The slope of steep natural watercourses (> 200 ft/mile) should be adjusted, as shown in the following figure.

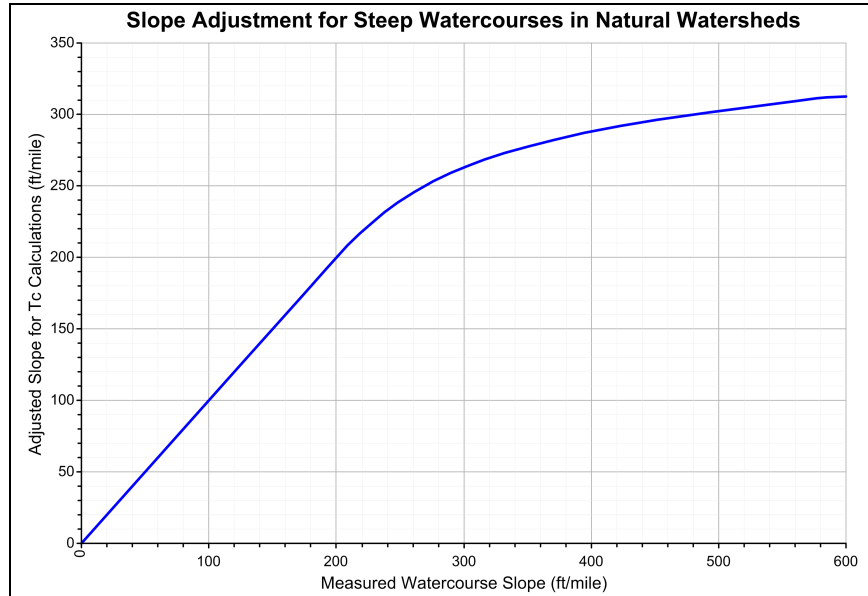

Figure 9.56 Slope adjustment for steep watercourses in natural watersheds (*Drainage Criteria Manual, Urban Drainage and Flood Control District, Colorado, May 1984*)

m, b, and K_b , Watershed Resistance Coefficients

These fields define m , b , and K_b , which are watershed resistance coefficients similar in concept to Manning’s roughness coefficient in open channel flow. These values are very subjective, and there is a high degree of uncertainty associated with their use. To diminish this uncertainty and to increase the reproducibility of the Papadakis Kazan TOC procedure, lookup tables are provided based on watershed classification and watershed size. Clicking the browse button adjacent to the b parameter field will display the Papadakis Kazan Coefficients reference dialog box, as shown below in Figure 9.57. Clicking the browse button adjacent to the K_b parameter field will display a second Papadakis Kazan Coefficients reference dialog box, as shown below in Figure 9.58.

Papadakis-Kazan Coefficients

Equation for Estimating K_b in the T_c Equation

$$K_b = m \log A + b$$

Where A is drainage area, in acres

Type	Description	Typical Applications	Equation Parameters	
			m	b
A	Minimal Roughness: Relatively smooth and / or well graded and uniform land surfaces. Surface runoff is sheet flow.	Commercial / industrial areas Residential areas Parks and golf courses	-0.00625	0.04
B	Moderately Low Roughness: Land surfaces have irregularly spaced roughness elements that protrude from the surface but the overall character of the surface is relatively uniform. Surface runoff is predominately sheet flow around the roughness elements.	Agricultural fields Pastures Desert rangelands Undeveloped urban lands	-0.01375	0.08
C	Moderately High Roughness: Land surfaces that have significant large-to medium-sized roughness elements and/or poorly graded land surfaces that cause the flow to be diverted around the roughness elements. Surface runoff is sheet flow for short distances draining into meandering drainage paths.	Hillslopes Brushy alluvial fans Hilly rangeland Disturbed land, mining, etc.	-0.02500	0.15
D	Maximum Roughness: Rough land surfaces with tortuous flow paths. Surface runoff is concentrated in numerous short flow paths that are often oblique to the main flow direction.	Mountains Some wetlands	-0.03000	0.20

Source: Table 5.3, Drainage Design Manual for Maricopa County

Figure 9.57 Papadakis Kazan Coefficients reference dialog box, providing resistance coefficients m and b as a function of watershed size and surface roughness characteristics (Table 5.3, Drainage Design Manual for Maricopa County, June 1992)

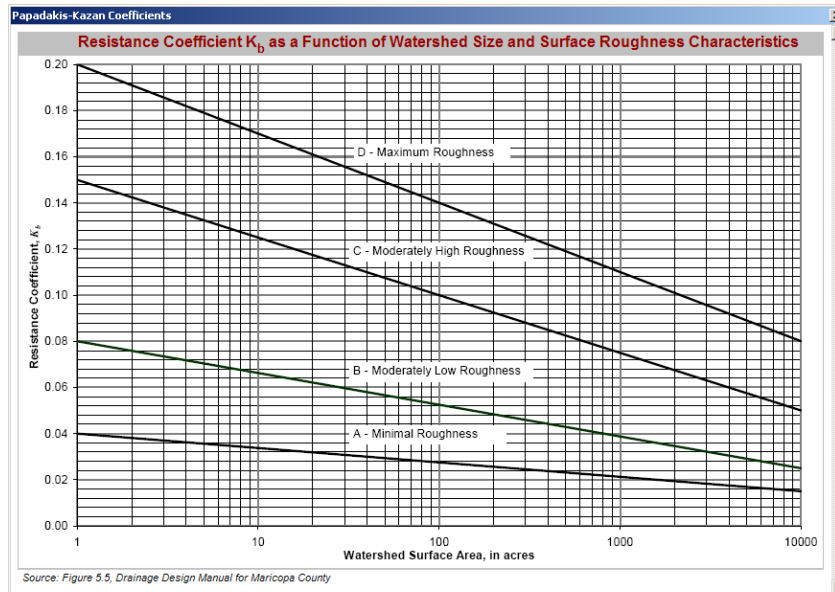

Figure 9.58 Papadakis Kazan Coefficients reference dialog box, providing resistance coefficient K_b as a function of watershed size and surface roughness characteristics (Figure 5.5, Drainage Design Manual for Maricopa County, June 1992)

Time of Concentration

Depending upon the time of concentration (T_c) method selected, this field may be a read-only field or allow you to specify a user-defined T_c . If the field is read-only, then the software uses other data to compute the T_c , and displays the computed T_c in this field. If *User Defined* was selected for the **TIME OF CONCENTRATION METHOD** in the Program Options dialog box (see page 167), then this field is used to define the T_c .

If this field is read-only, then click the browse button to display a summary report on the time of concentration computations, as shown in the following figure.

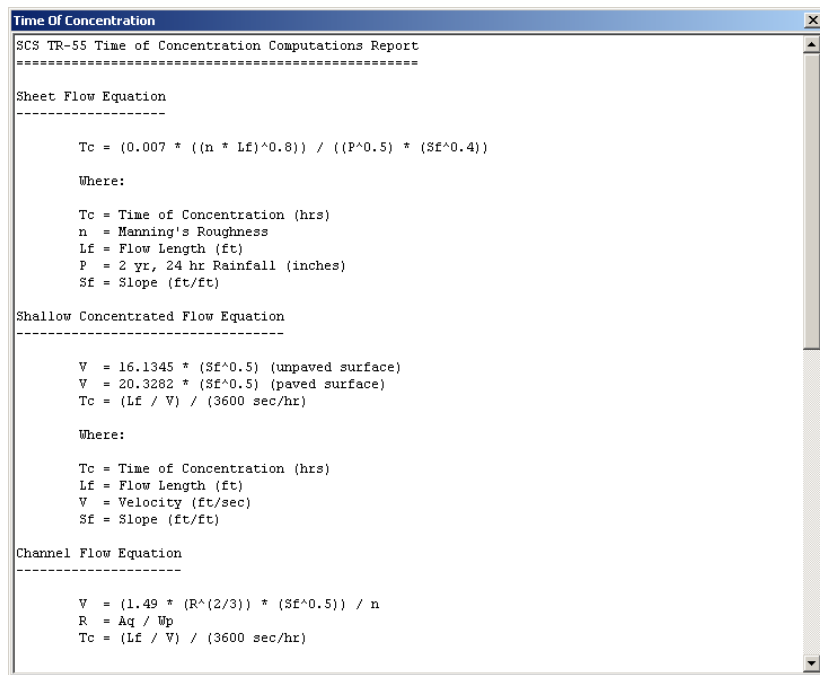

Figure 9.59 The summary report showing the time of concentration number computations for the current subbasin

Storage Coefficient

This field represents the Clark basin storage coefficient (in hours). The basin storage coefficient is an index of the temporary storage of precipitation excess in the watershed as it drains to the outlet point. It can be estimated via calibration if gaged precipitation and streamflow data are available. Though basin storage coefficient has units of time, there is only a qualitative meaning for it in the physical sense. Clark (1945) indicated that the basin storage coefficient can be computed as the flow at the inflection point on the falling limb of the hydrograph divided by the time derivative of flow.

Depending upon the time of concentration method selected, this field may be a read-only field or allow you to specify a user-defined Storage Coefficient. If the field is read-only, then the software uses other data to compute the Storage Coefficient and displays the computed value in this field.

Time Area Curve

This check box enables defining a time-area curve. The time-area curve defines the cumulative area of the subbasin contributing runoff to the subbasin outlet as a function of time (expressed as a proportion of TOC). Click the browse button to display the Time-Area Curve dialog box, as shown in the following figure.

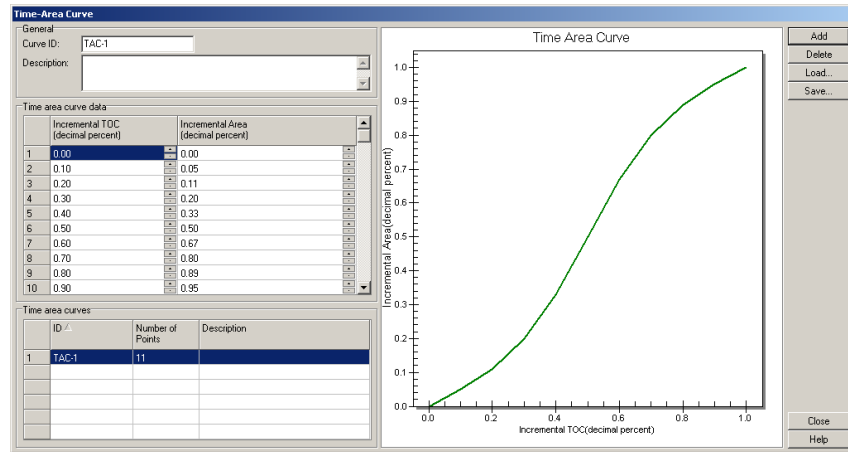

Figure 9.60 The Time-Area Curve dialog box defines the cumulative area of the subbasin contributing runoff to the subbasin outlet as a function of time (expressed as a proportion of TOC)

To define a time-area curve, the watershed is broken into areas of approximately equal travel time. These lines of equal travel time are known as isochrones. The following figure illustrates the breaking of a watershed into areas by isochrones. The mean travel time of each sub-area is calculated and the resulting time-area curve is produced. Summing the incremental areas and corresponding travel times defines the cumulative time-area curve as required for the Clark unit hydrograph method. The total time can be thought of as the time of concentration of the watershed with 100% of the basin area being accounted for at the time of concentration.

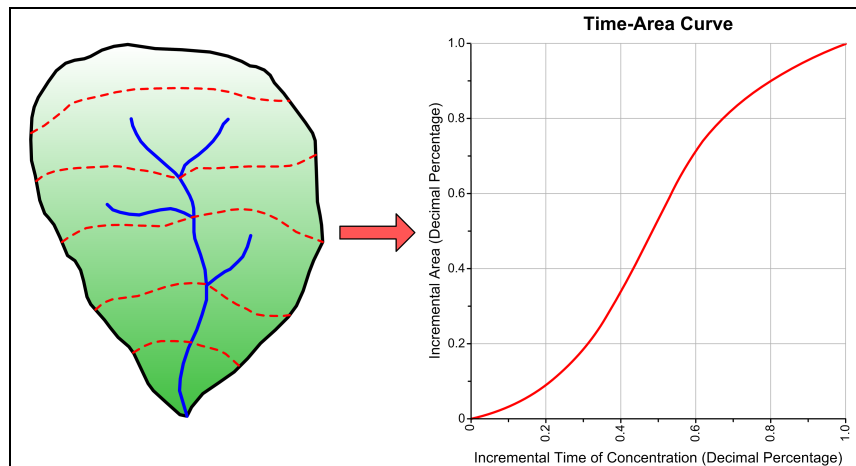

Figure 9.61 Hypothetical watershed divided into areas of approximate equal travel time to the outlet

The area between each isochrone and subbasin outlet is planimetered and the corresponding incremental area of the total subbasin area is computed. A corresponding incremental time of concentration is computed, and the data pair is defined in the Time-Area Curve dialog box.

$$A_i = \frac{A_{iso}}{A_{tot}}$$

$$T_i = \frac{T_{iso}}{T_{tot}}$$

where:

- A_i = incremental area of the total subbasin area, represented as a fraction
- A_{iso} = cumulative area up to the current isochrone
- A_{tot} = subbasin total area
- T_i = incremental time of concentration of the total subbasin time of concentration, represented as a fraction
- T_{iso} = cumulative time of concentration up to the current isochrone
- T_{tot} = subbasin time of concentration

In the case that you do not provide a time-area curve, HEC-1 will compute a dimensionless time-area curve, using the following relationship:

$$A_i = 1.414T_i^{1.5} \quad 0 \leq T_i < 0.5$$

$$1 - A_i = 1.414(1 - T_i)^{1.5} \quad 0.5 \leq T_i < 1$$

SCS Dimensionless Unit Hydrograph Method

The Soil Conservation Service (SCS) dimensionless unit hydrograph procedure is one of the most well known methods for deriving synthetic unit hydrographs in use today. *(Note that the SCS agency is now known as the Natural Resources Conservation Service or NRCS, but the acronym SCS is still used in association with its unit hydrograph and time of concentration methods.)*

The SCS unit hydrograph method was originally developed from observed data collected in small, agricultural watersheds from across the country. This data were generalized as a dimensionless unit hydrograph which can be scaled by time lag to produce the unit hydrograph for use. It is interesting to note that 37.5% of the runoff volume occurs before the peak flow and the time base of the hydrograph is five times the lag.

The Loss & UH Parameters tab for the SCS Dimensionless Unit Hydrograph Method is shown in the following figure.

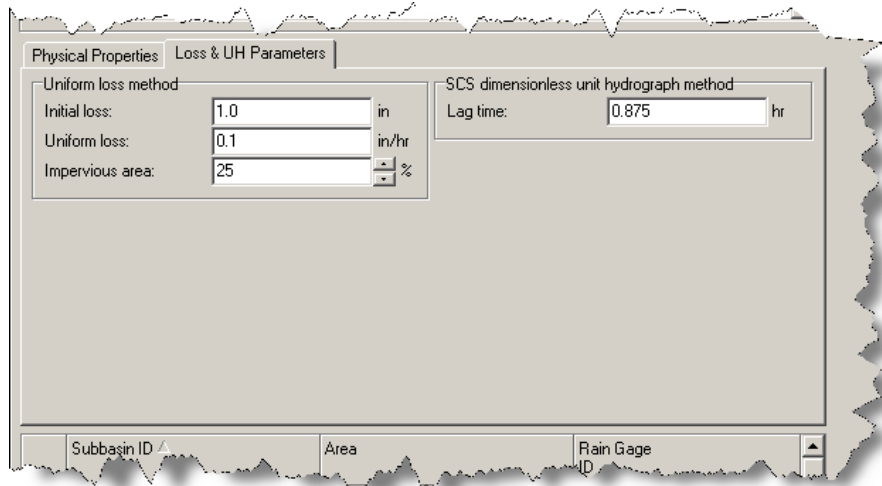

Figure 9.62 The Loss & UH Parameters tab for the SCS Dimensionless Unit Hydrograph Method

Lag Time

This field defines the SCS lag time in hours. SCS lag time value based upon the computed time of concentration, using the following relationship:

$$t_{lag} = 0.6t_c$$

where:

$$t_{lag} = \text{lag time}$$

$$t_c = \text{time of concentration}$$

Snyder Unit Hydrograph Method

The Snyder Unit Hydrograph method was developed for Appalachian area watersheds ranging from 10 to 10,000 square miles. This method has been successfully applied to watersheds across the United States by the US Army Corps of Engineers. The Snyder Unit Hydrograph method provides a means of generating a synthetic unit hydrograph by calculating the lag time, peak flow, and total time base through two relationships involving drainage area, length measurements, and estimated parameters. Because the Snyder method does not directly define the final hydrograph shape, the HEC-1 implementation of the Snyder method utilizes a unit hydrograph generated with the Clark method such that the empirical Snyder relationships are maintained.

The Loss & UH Parameters tab for the Snyder Unit Hydrograph Method is shown in the following figure.

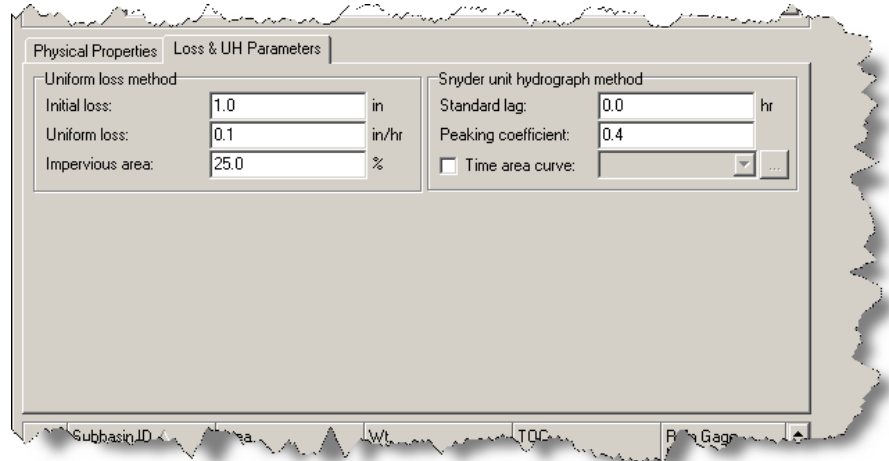

Figure 9.63 The Loss & UH Parameters tab for the Snyder Unit Hydrograph Method

Standard Lag

This field defines Snyder's standard lag in hours. Snyder's standard lag can be estimated as a function of the subbasin time of concentration (Cudworth, 1989; USACE, 1987). Various studies estimate Snyder's standard lag as 50-75% of the subbasin time of concentration.

Peaking Coefficient

This field defines Snyder's peaking coefficient.

User Defined Unit Hydrograph Method

The User Defined Unit Hydrograph method can be used to match observed runoff flows from a specific historical event, or it can be from a hypothetical storm.

The Loss & UH Parameters tab for the User Defined Unit Hydrograph Method is shown in the following figure.

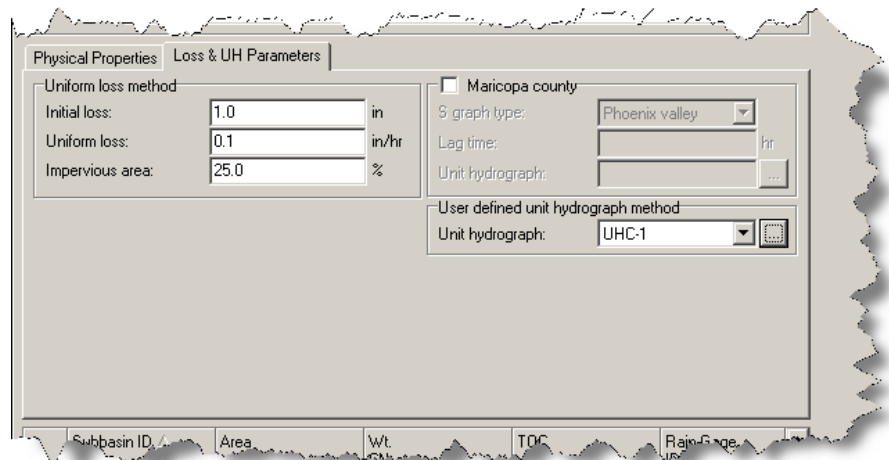

Figure 9.64 The Loss & UH Parameters tab for the User Defined Unit Hydrograph Method

Maricopa County

This check box allows you to disable/enable the Maricopa County (Arizona) Unit Hydrograph section. When this check box is disabled, the Maricopa County fields are grayed out (not available).

S Graph Type

An S-graph is a dimensionless form of the unit hydrograph and can be used in place of a unit hydrograph in performing flood hydrology studies. The concept of the S-graph dates back to the development of the unit hydrograph, although the application of S-graphs is not as widely practiced as that of unit hydrographs.

S-graphs have been developed for Maricopa County, which are provided in the the drop-down list:

- Phoenix Valley
- Phoenix Mountain
- Desert Rangeland
- Agricultural

The Phoenix Mountain S-graph is to be used in flood hydrology studies of watersheds that drain predominantly mountainous terrain, such as Agua Fria River above Rock Springs, New River above the Town of New River, the Verde River, Tonto Creek, and the Salt River above Phoenix. Although the Corps of Engineers have developed a separate S-graph for Indian Bend Wash, it is nearly identical to the Phoenix Mountain S-graph which may also be appropriate for Indian Bend Wash.

The Phoenix Valley S-graph is appropriate for flood hydrology studies of watersheds that have little topographic relief and/or urbanized watersheds. However, the Clark Unit Hydrograph Method is still the preferred unit hydrograph method for use in urban areas in Maricopa County. The Desert Rangeland S-graph is appropriate for use in natural areas with little to moderate relief, such as foothills, distributary flow areas, and other undeveloped desert areas. The Agricultural S-graph, as the name suggests, should be used for areas under agricultural crops like cotton, wheat, or vegetables.

The above Maricopa County S-graphs should only be applied to large, natural watersheds. The Phoenix Valley S-graph can also be applied to large, urban basins. This is in part due to the fact that the original observed data applied the methodology to large Arizona watersheds. As a lower limit of application, a watershed area of 5 mi² can be considered.

Lag Time

This field defines the SCS lag time in hours. SCS lag time value based upon the computed time of concentration, using the following relationship:

$$t_{lag} = 0.6t_c$$

where:

$$\begin{aligned} t_{lag} &= \text{lag time} \\ t_c &= \text{time of concentration} \end{aligned}$$

Unit Hydrograph

This drop-down list allows you to select the unit hydrograph to use. Click the browse button to display the Unit Hydrograph dialog box, as shown in the following figure.

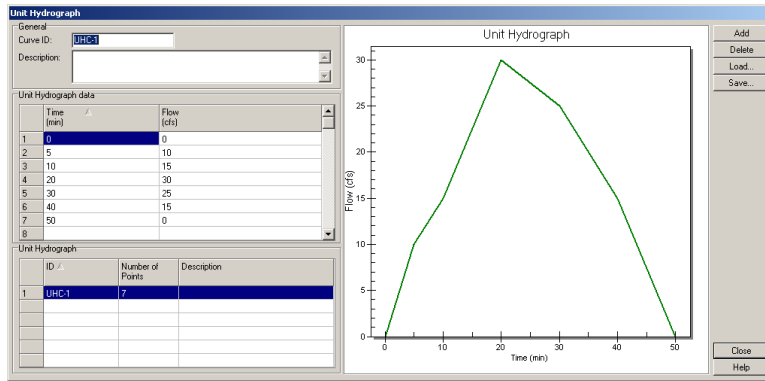

Figure 9.65 The Unit Hydrograph dialog box

The Unit Hydrograph dialog box allows you to define unit hydrograph flow values to use. Up to 150 values can be entered.

Kinematic Wave Method

As an alternative to the previously listed synthetic unit hydrograph methods, HEC-1 includes a conceptual Kinematic Wave Method for modeling the subbasin runoff response. The Kinematic Wave Method represents the subbasin as an open channel (a very wide, open channel), with inflow to the channel equal to the excess precipitation. It then solves the equations that simulate unsteady shallow water flow in an open channel to determine the subbasin runoff hydrograph.

The Kinematic Wave method is principally used for representing urban areas, although it can be used for undeveloped regions as well. It is a conceptual model that includes one or two representative overland flow planes. Typically, one overland flow plane is used for pervious areas and the other plane for impervious areas. The same meteorological boundary conditions are applied to each plane. However, separate loss rate information is required for each plane and is entered separately as part of the loss method.

Basic Concepts

Figure 9.66(a) shows a simple watershed for which runoff is to be computed for design, planning, or regulating. For kinematic wave routing, the watershed and its channels are conceptualized as shown in Figure 9.66(b). This represents the watershed as two plane surfaces over which water runs until it reaches the channel. The water then flows down the channel to the outlet. At a cross section, the system would resemble an open book, with the water running parallel to the text on the page (down the shaded planes) and then into the channel that follows the book's center binding.

The kinematic wave overland flow model represents behavior of overland flow on the plane surfaces. The model may also be used to simulate behavior of flow in the watershed channels.

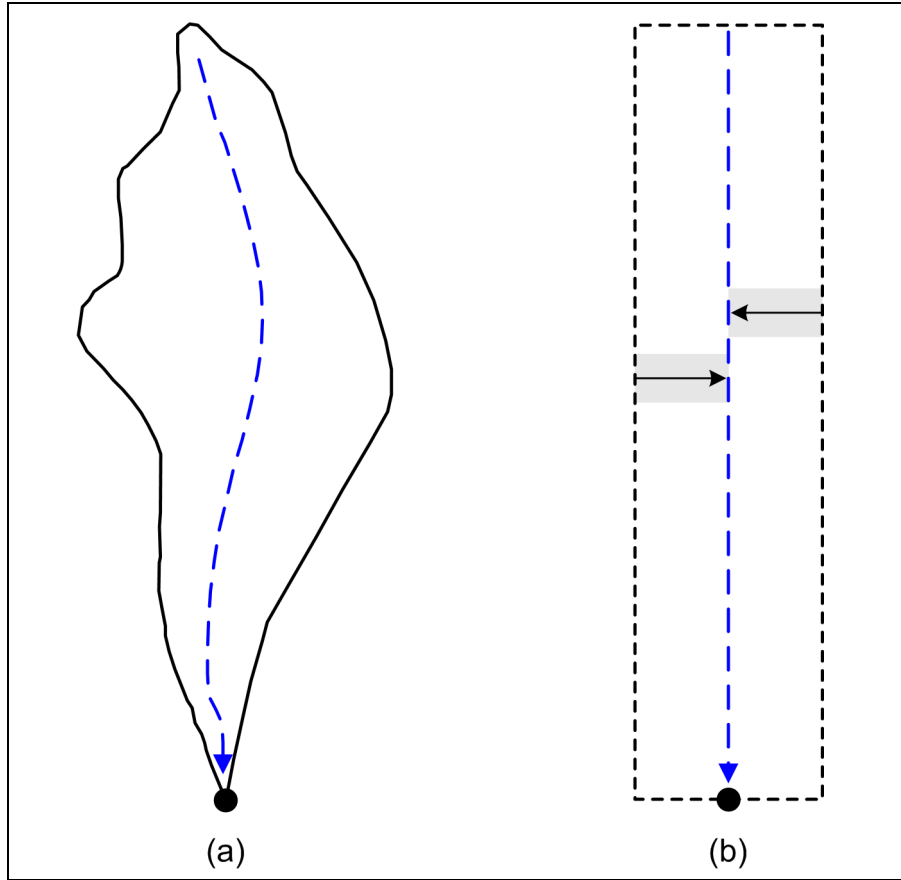

Figure 9.66 Simple watershed with kinematic wave model representation

Setting Up the Kinematic-Wave Method and Estimating Parameters

To estimate runoff with the kinematic-wave method, the watershed is described as a set of elements that include:

- **Overland Flow Planes**

Up to two planes that contribute runoff to channels within the watershed can be described. The combined flow from the planes is the total inflow to the watershed channels. Column 1 of Table 9.3 shows information that must be provided about each plane.

- **Subcollector Channels**

These are small feeder pipes or channels, with principle dimension generally less than 18 inches, that convey water from street surfaces, rooftops, lawns, and so on. They might service a portion of a city block or housing tract, with area of 10 acres. Flow is assumed to enter the channel uniformly along its length. The average contributing area for each subcollector channel must be specified. Column 2 of Table 9.3 shows information that must be provided about the subcollector channels.

- **Collector Channels**

These are channels, with principle dimension generally 18-24 inches, which collect flows from subcollector channels and convey it to the main channel. Collector channels might service an entire city block or a housing tract, with flow entering laterally along the length of the channel. As with the subcollectors, the average contributing area for each collector channel is required. Column 2 of Table 9.3 shows information that must be provided about the collector channels.

- **Main Channel**

This channel conveys flow from upstream subwatersheds and flows that enter from the collector channels or overland flow planes. Column 3 of Table 9.3 shows information that must be provided about the main channel.

The choice of elements to describe any watershed depends upon the configuration of the drainage system. The minimum configuration is one overland flow plane and main channel, while the most complex would include two planes, subcollectors, collectors, and main channel. The Kinematic Wave Routing Method requires at least one overland flow plane and one main channel to be used.

Table 9.3 Hydrologic information needs for kinematic wave modeling (HEC-HMS Technical Reference Manual, March 2000)

Overland Flow Planes	Collectors and Subcollectors	Main Channel
Typical length	Area drained by channel	Channel length
Representative slope	Channel length	Channel shape
Overland-flow roughness	Channel shape	Cross section geometry
Drainage area represented by overland flow plane	Principle dimensions of representative channel cross section	Channel slope
Loss parameters	Channel slope	Manning's roughness
	Manning's roughness	

The tab for defining the overland flow plane data for the Kinematic Wave Method is shown in the following figure.

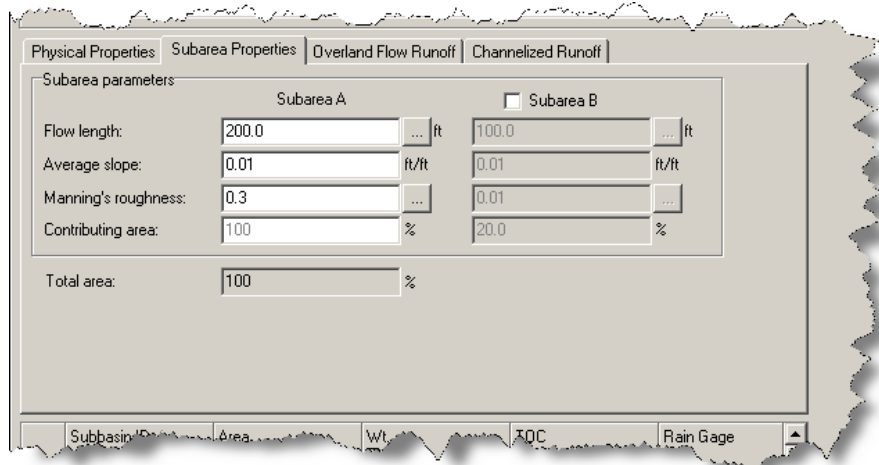

Figure 9.67 The Subarea Properties tab defines the overland flow plane data for the Kinematic Wave Method

Flow Length

Specify the flow length for the overland flow planes runoff flow. Click the browse button in order to measure this distance from the Plan View. The software will temporarily hide the Subbasin dialog box while you trace the overland flow plane runoff flow path on the subbasin. When completed measuring this distance, right-click or press Enter and the measured distance will be placed in the **FLOW LENGTH** field.

Slope

Specify the average slope (in ft/ft or m/m) for the overland flow planes.

Manning's Roughness

Specify the Manning's roughness coefficient for the overland flow planes. The Manning's roughness value for the overland flow planes is an effective roughness coefficient that includes the effect of raindrop impact; drag over the plane surface; obstacles such as litter, crop ridges, and rocks; and erosion and transportation of sediment. These roughness values are for very shallow flow depths of about 0.1 foot or less.

Clicking the browse button will display the Manning's Roughness reference dialog box, as shown previously in Figure 9.7 on page 325, which lists typical overland flow Manning's roughness values based upon land surface type (i.e., grassy or open soil, etc.).

Contributing Area

If two overland flow planes are being used to define runoff flow for the subbasin, then the check box **SUBAREA B** should be checked. This will enable additional data fields for Subarea B as well as enable the **CONTRIBUTING AREA** field. Otherwise, this field remains grayed out and a default contributing area value of 100% is provided.

When defining contributing areas for Subarea A and Subarea B, this field defines the percentage area of the subbasin that this subarea represents. The contributing area percentages for the two subareas must add up to 100%, as is reported in the **TOTAL AREA** field.

Two subareas (or subcatchments) are typically used to describe the pervious and impervious portions of a subbasin.

The Channelized Runoff tab for defining the main channel and collector channel subbasin runoff data for the Kinematic Wave Routing Method is shown below in Figure 9.68. The Channelized Runoff tab for defining the main channel and collector channel subbasin runoff data for the Muskingum Cunge Routing Method is shown below in Figure 9.69.

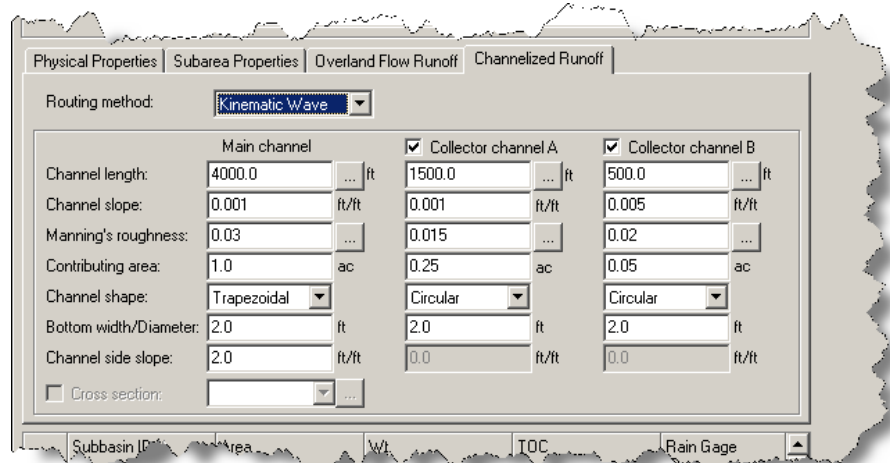

Figure 9.68 The Channelized Runoff tab for defining the main channel and collector channel subbasin runoff data for the Kinematic Wave Routing Method

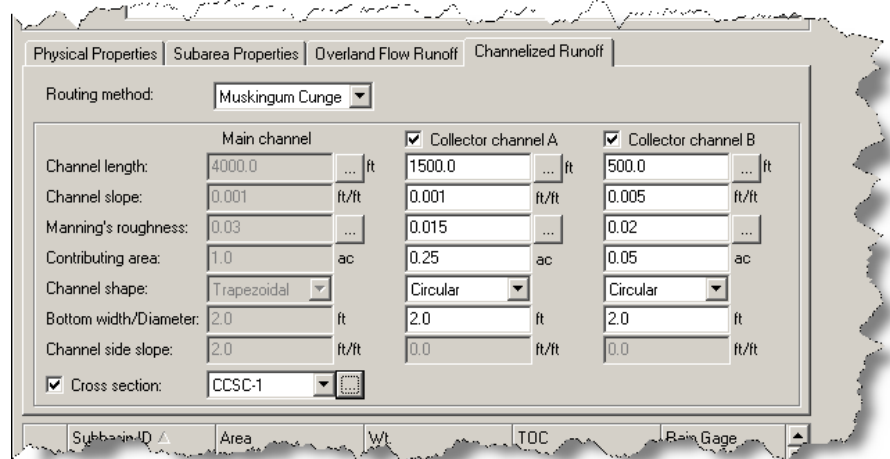

Figure 9.69 The Channelized Runoff tab for defining the main channel and collector channel subbasin runoff data for the Muskingum Cunge Routing Method

Routing Method

This drop-down list defines the routing method to use for the main channel and collector channel subbasin runoff data. The following methods are available:

- Kinematic Wave
- Muskingum Cunge

Channel Length

Specify the flow length for the main and collector channels (in feet or meters). Click the (...) browse button in order to measure this distance from the Plan View. The software will temporarily hide the Subbasin dialog box while you

trace the channelized runoff flow path on the subbasin. When completed measuring this distance, right-click or press Enter and the measured distance will be placed in the **CHANNEL LENGTH** field.

Channel Slope

This field defines the main and collector channel slope (in ft/ft or m/m).

Manning’s Roughness

Specify the Manning's roughness coefficient for the main and collector channels. Clicking the (...) browse button will display the Manning’s Roughness reference dialog box, as shown in the following figure, which lists typical channelized flow Manning’s roughness values based upon channel type (i.e., lined, excavated, or natural channel, etc.).

Channel Type	Manning n		
	Minimum	Normal	Maximum
1. Lined or Constructed Channels			
a. Cement:			
1. Neat, surface	0.010	0.011	0.013
2. Mortar	0.011	0.013	0.015
b. Concrete:			
1. Trowel finish	0.011	0.013	0.015
2. Float finish	0.013	0.015	0.016
3. Finished, with gravel on bottom	0.015	0.017	0.020
4. Unfinished	0.014	0.017	0.020
5. Gunite, good section	0.016	0.019	0.023
6. Gunite, wavy section	0.018	0.022	0.025
7. On good excavated rock	0.017	0.020	-
8. On irregular excavated rock	0.022	0.027	-
c. Concrete Bottom Float Finish with sides of:			
1. Dressed stone in mortar	0.015	0.017	0.020
2. Random stone in mortar	0.017	0.020	0.024
3. Cement rubble masonry, plastered	0.016	0.020	0.024
4. Cement rubble masonry	0.020	0.025	0.030
5. Dry rubble or riprap	0.020	0.030	0.035
d. Gravel Bottom with sides of:			
1. Formed concrete	0.017	0.020	0.025
2. Random stone mortar	0.020	0.023	0.026

Figure 9.70 The Manning’s Roughness reference dialog box for channelized runoff flow

Contributing Area

Specify the contributing area that is serviced by the main channel and collector channel, in acres or ha. An approximate value can be entered.

Channel Shape

This drop-down list allows you to select the channel element type. Available shapes include:

- Trapezoidal** This is the default shape, and includes triangular and rectangular channels.
- Square** This represents a deep rectangular (square) channel. The flow depth is approximately equal to the channel width.
- Circular** This channel shape approximates the flow in a pipe or culvert. Flow depths are allowed to exceed the pipe diameter.

Bottom Width Diameter

Specify the channel bottom width (or diameter if defining a circular pipe).

Channel Side Slope

Specify the channel side slopes, in 1 vertical to n horizontal. This is only required for trapezoidal channel shapes.

Cross Section

This drop-down list allows you to select a more detailed 8-point cross section when using the Muskingum Cunge routing method. Click the browse button to display the 8-Point Cross Section dialog box, as shown below in Figure 9.72.

If one of the standard cross-section shapes will not represent the channel geometry, an 8-point cross section can then be used to more accurately define the channel geometry. With an 8-point cross section, a representative cross section is described for the routing reach using 8 pairs of x, y (distance, elevation) values. The data used to define this cross section is illustrated below in Figure 9.71. Points labeled 3 and 6 represent the left and right banks of the channel of the defined cross section. Points 4 and 5 are within the channel. Points 1 and 2 represents the left overbank area, and points 7 and 8 represent the right overbank area.

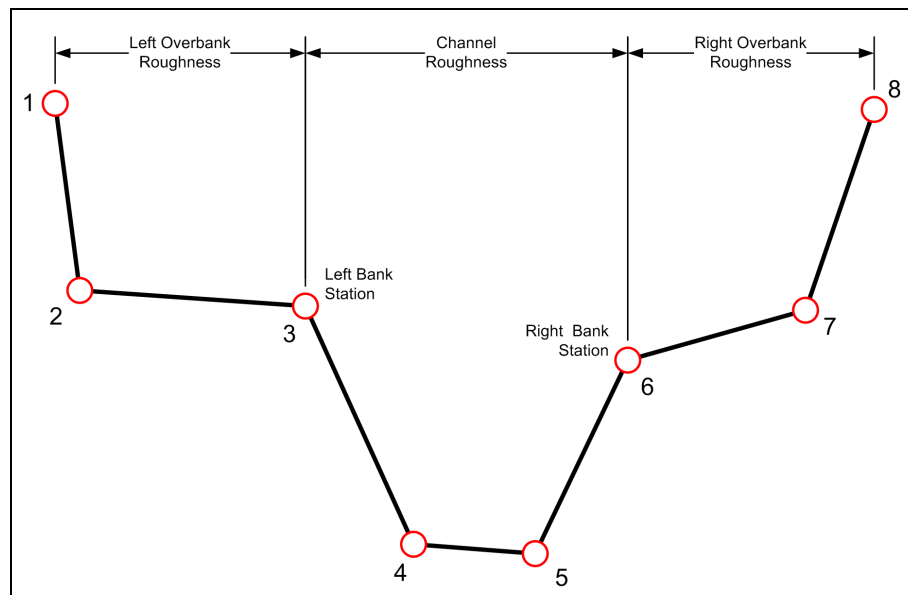

Figure 9.71 Input data used to define an 8-point cross section

The reach length, Manning’s roughness coefficients, and energy gradeline slope must also be defined. As with the standard cross section shapes, the flow length and roughness can be estimated from maps, aerial photographs, and field surveys, and the energy gradeline slope can be estimated as the channel bed slope, in the absence of better information.

With either configuration of the Muskingum-Cunge model, if the channel properties vary significantly along the routing reach, the reach may be subdivided and modeled as a series of linked subreaches, with the properties of each defined separately.

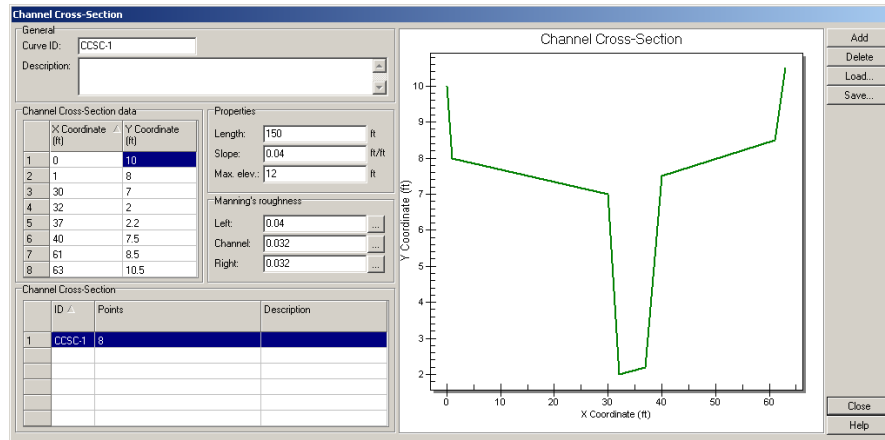

Figure 9.72 The 8-Point Cross Section dialog box allows you to define a more detailed cross section geometry when using the Muskingum Cunge routing method

Channel X-Y Coordinate Data

Specify 8 coordinate pairs to define the channel in the routing reach. The left bank station is defined at the 3rd coordinate pair, and the right bank station is defined at the 6th coordinate pair.

Length

Define the length for which the routing computations are being represented.

Slope

Specify the energy gradeline slope (in ft/ft or m/m) for normal flow conditions. However, this is generally unknown, and can be approximated using the channel bottom or floodplain slope.

Max Elevation

Specify the maximum elevation for which storage and outflow values are to be computed. By default, this value represents the maximum elevation defined in the X-Y coordinate pair data.

Left, Channel, Right Manning's Roughness

Specify the Manning's roughness coefficients for the left overbank, channel, and right overbank subareas. Clicking the (...) browse button will display the Manning's Roughness reference dialog box, as shown above in Figure 9.70, which lists typical channelized flow Manning's roughness values based upon channel type (i.e., lined, excavated, or natural channel, etc.).

HEC-1 Flood Routing

Note that the software provides the HEC-1 hydrology method for computing surface runoff. However, the routing of the HEC-1 hydrology runoff as channel or river flow is performed by the internal routing methods defined by the entry **LINK ROUTING METHOD** in the Project Options dialog box, General tab, described on page 174.

Exporting HEC-1 Input Data Files

To export the HEC-1 input data file (i.e., card file), select **FILE ► EXPORT ► HEC-1 FILE**. The Export HEC-1 File dialog box will then be displayed, allowing you to navigate to where you want to save HEC input data file. Define the HEC-1 data filename and then click Save.

Subbasin Delineation

Discretization of the drainage basin converts the physical drainage system into a mathematical abstraction that the software can understand. For the computation of hydrographs, the drainage basin must be conceptually represented by a network of hydraulic elements (i.e., subbasins, channels, and pipes). Hydraulic properties of each element are then characterized by various parameters, such as size, slope, and roughness.

Subbasins represent idealized runoff areas with uniform slope. Parameters such as roughness values, depression storage, and infiltration values are taken to be constant for the subbasin area and usually represent averages, although pervious and impervious areas are defined with different characteristics within the subbasin. If roofs drain onto pervious areas, such as lawns, they are generally considered part of the pervious area (although, conceivably, they could be treated as miniature subcatchments themselves).

Discretization begins with identification of drainage boundaries using a topographic map, the location of major sewer inlets using a sewer system map, and the selection of those channels and pipes to be included in the model.

An example regional watershed delineation is illustrated in the following figure.

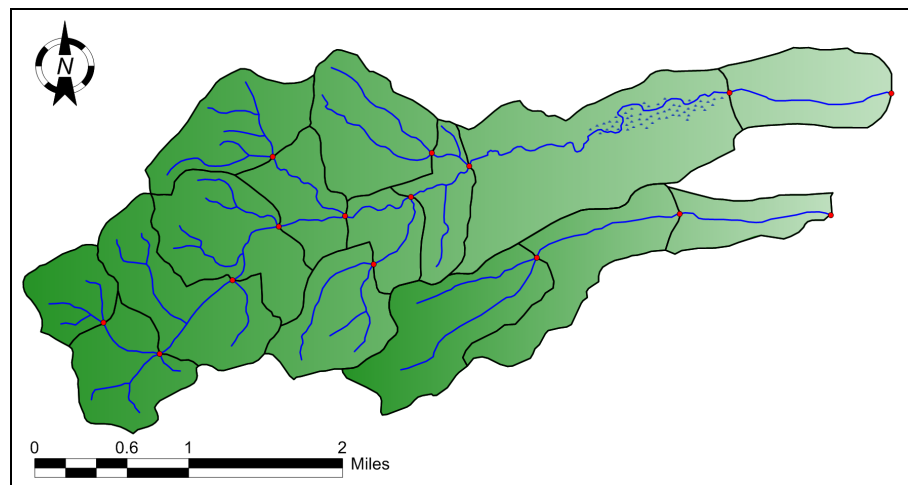

Figure 9.73 Example watershed delineation

Difficulties in determining the watershed contributing areas can occur if the natural watercourse has been heavily modified and piped. As shown below, the previous natural catchment boundary was changed when a highway and urbanized watercourse was introduced, conveying flow across the previous catchment. Therefore, you should review available topographical and piping data to understand the full impact on the catchment characteristics and boundaries, and revise them if necessary

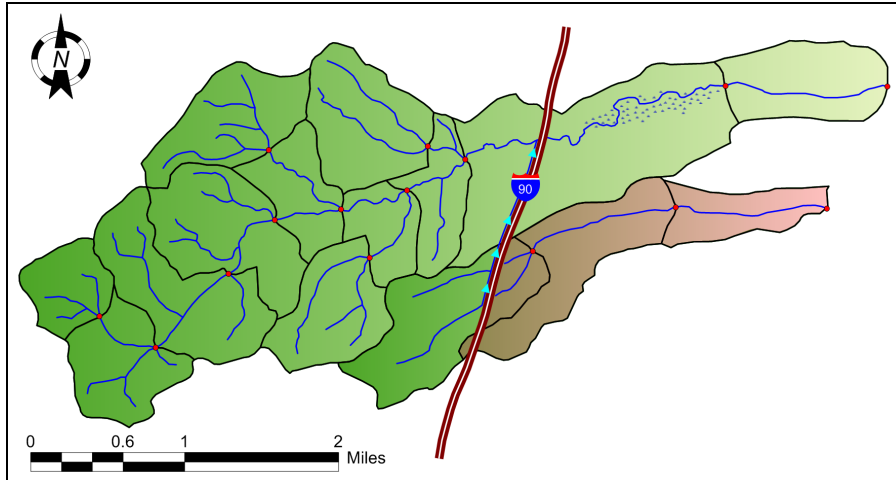



Figure 9.74 Natural watershed catchment boundaries being significantly changed as a result of an urbanized watercourse (blue line) crossing catchment boundaries

Rain Gages

Rain gages supply rainfall data for one or more subbasins in the study area. The rainfall data can either be a user-defined time series or described in an external file. Several different popular rainfall file formats are supported, as well as user-defined formats.

The principal input data of a rain gage include:

- Rainfall data type (e.g., intensity, volume, or cumulative volume)
- Recording time interval (e.g., hourly, 15-minute, etc.)
- Source of rainfall data (input time series or external file)
- Name of rainfall data source

The Rain Gages dialog box, as shown in the following figure, is displayed when an existing rain gage is selected for editing by double-clicking it in the Plan View using the **SELECT ELEMENT**  tool. Also, you can choose **INPUT > RAIN GAGES** or double-click the **RAIN GAGES**  icon from the data tree to display the Rain Gages dialog box.

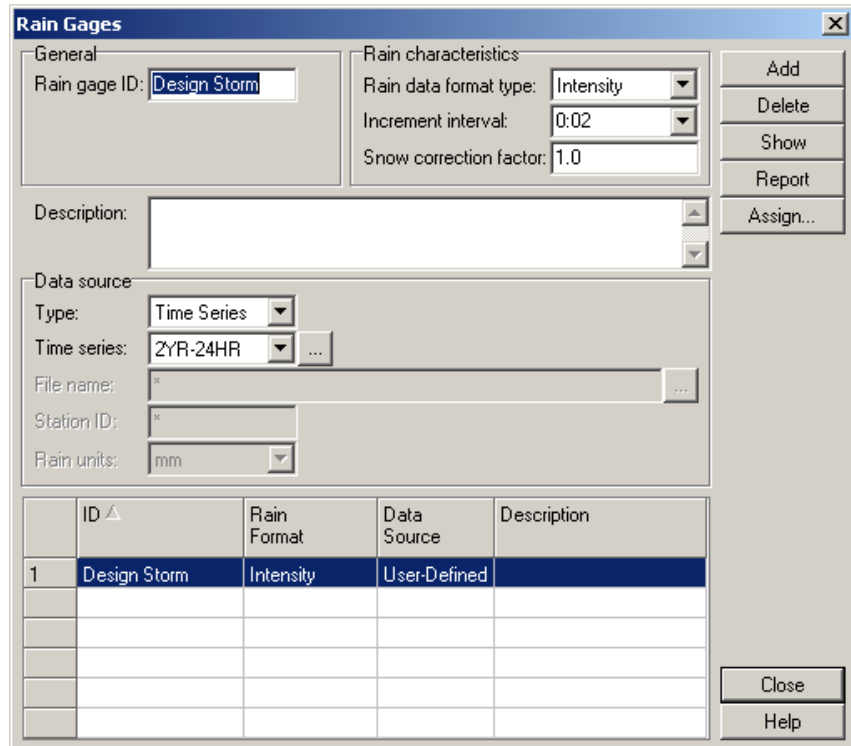

Figure 9.75 The Rain Gages dialog box

To select a rain gage, scroll through the displayed table and click the row containing the rain gage of interest. The provided data entry fields will then display information describing the selected rain gage.

To add a new rain gage, it is recommended that the rain gage be added interactively on the Plan View using the **ADD RAIN GAGE** tool. However, a new rain gage can be manually added by clicking the Add button and then entering the appropriate information in the provided data entry fields. When this is done, the rain gage is not shown on the Plan View.

To delete an existing rain gage, select the rain gage from the table and then click the Delete button. Click the Show button to zoom to a region around the currently selected rain gage in the Plan View, and then highlight the rain gage. Click the Report button to generate a Microsoft Excel report detailing all currently defined rain gages. Click the Assign button and the software will display a dialog box confirming whether to assign the current rain gage to all subbasins.

The following data are used to define a rain gage:

Rain Gage ID

Enter the unique name (or ID) that is to be assigned to the rain gage being defined. This name can be alphanumeric (i.e., contain both numbers and letters), can contain spaces, is case insensitive (e.g., *ABC = abc*), and can be up to 128 characters in length. Therefore, the assigned name can be very descriptive, to assist you in identifying different rain gages.

A new rain gage ID is automatically defined by the software when a new gage is added. However, the rain gage ID can be changed within this field.

When importing (or merging) multiple stormwater network models into a single model, the software will check for collisions between identical rain gage IDs and can automatically assign a new rain gage ID for any gages being imported that contain the same rain gage ID as already exist in the network model. See the section titled *Merging Network Models* on page 494 for more information.

Description (optional)

Enter an optional description that describes the rain gage being defined.

Rain Format

This drop-down list allows you to select the format that the rain data is to be supplied as:

- Cumulative** Each rainfall value represents the cumulative rainfall that has occurred since the start of the last series of non-zero values (in inches or mm).
- Intensity** Each rainfall value is an average rate in inches/hour (or mm/hour) over the recording interval.
- Volume** Each rainfall value is the volume of rain that fell in the recording interval (in inches or mm). This format option is not often used.

Increment Interval

Specify the time interval between gage readings in hours:minutes format.

Note that the rain gage increment interval has to match the time step of the defined rainfall time series. When you assign the rainfall time series, the software automatically checks to see what corresponding time step of the time series is and sets the rain gage increment interval to this value.

Snow Correction Factor

Specify the multiplication factor that corrects gage readings for snowfall.

Precipitation gages tend to produce inaccurate snowfall measurements because of the complicated aerodynamics of snowflakes falling into the gage. Snowfall totals are generally underestimated as a result, by a factor that varies considerably depending upon gage exposure, wind velocity, and whether or not the gage has a wind screen.

In addition, all snow fall amounts are treated as “depth of water equivalent,” which for new snow is of the order of 0.09. Generally, an 11:1 or 10:1 ratio of snow depth to water equivalent depth is used.

Data Source Type

From the drop-down list, select the source for the rainfall data, as:

- | | |
|----------------------|----------------------------------------------------------------------------------------------------------------------------------------------------------------------------------|
| External File | Rainfall data is read from an external data file. Supported rainfall file formats are described below. Note that this option is only supported by the EPA SWMM hydrology method. |
| Time Series | Rainfall data is entered as a user-defined time series data. This is the most commonly used option. |

Time Series

This drop-down list allows you to select an already defined time series that contains the tabular data of time versus rainfall for the rain gage. Click the browse button to display the Time Series dialog box (described on page 467) and related Rainfall Designer (described on page 392) to define a rainfall time series.

File Name (external rainfall file only)

If using an external file for rainfall data, this defines the filename and subdirectory path for the external file containing the rainfall data. Note that this option is only supported by the EPA SWMM hydrology method.

Station ID (external rainfall file only)

If using an external file for rainfall data, this defines the Station ID (column ID) that contains the rainfall data.

Rain Units (external rainfall file only)

If using an external file for rainfall data, this defines the depth units (in inches or mm) for the rainfall data.

Directly Assigning Storm Precipitation

Instead of defining a rain gage and assigning it to the subbasins in a model, you can directly assign the storm to be analyzed using the Analysis Options dialog box. See the section titled *Storm Selection* on page 76 for more information.

Rational Method, Modified Rational, DeKalb Rational Methods

Note that when you are using the Rational Method, DeKalb Rational Method, or Modified Rational hydrology method, then a rain gage is not used to define the precipitation for the model. Instead, an Intensity Duration Frequency (IDF) distribution (or equivalent method) is used to specify the rainfall intensity and duration to be modeled. This is described in detail in the section titled *IDF Curves* on page 398.

SCS TR-55 and SCS TR-20 Hydrology Methods

If using rain gages to assign storm precipitation to the drainage model, the SCS TR-55 and SCS TR-20 hydrology methods only allow one rain gage to be assigned to a model.

External Rainfall Files

Rain gages can utilize rainfall data stored in external rainfall files. External rainfall files are only supported by the EPA SWMM hydrology method.

The following formats for storing such data are currently supported:

- **DSI-3240** and related formats which record hourly rainfall at U.S. National Weather Service (NWS) and Federal Aviation Agency (FAA) stations, available online from the National Climatic Data Center (NCDC) at: www.ncdc.noaa.gov/oa/ncdc.html
- **DSI-3260** and related formats which record fifteen minute rainfall at NWS stations, also available online from NCDC.
- **HLY03** and **HLY21** formats for hourly rainfall at Canadian stations, available online from Environment Canada at: www.climate.weatheroffice.ec.gc.ca
- **FIF21** format for fifteen minute rainfall at Canadian stations, also available online from Environment Canada.
- A standard user-prepared format where each line of the file contains the station ID, year, month, day, hour, minute, and non-zero precipitation reading, all separated by one or more spaces.

An example from a user-prepared rainfall file is shown below:

```
STA01 2004 6 12 00 00 0.12  
STA01 2004 6 12 01 00 0.04  
STA01 2004 6 22 16 00 0.07
```

Figure 9.76 Example user-prepared external rainfall file

When a rain gage is designated as receiving its rainfall data from an external file, the name of the file and the name of the recording station referenced in the file must be specified in the Rain Gage dialog box. For the standard user-prepared format, the rainfall type (e.g., intensity or volume), recording time interval, and depth units must also be supplied as rain gage properties. For the other external rainfall file types, these properties are defined by their respective file format and are automatically recognized by the software.

Rainfall Designer

The software includes a Rainfall Designer which allows you to select any location within the USA and it will provide the design rainfall for the specified storm frequency. Alternatively, a user-defined rainfall can be specified. Then the appropriate storm distribution can be selected and the design storm is then created. Multiple design storms can be created.

The Rainfall Designer provides the following capabilities:

- Automatically determines design rainfall (based upon study location) for 1, 2, 5, 10, 25, 50, and 100 year return frequencies
- Defines any storm duration
- Multiple storm events can be created
- Numerous storm distributions, including SCS, Huff, Eastern Washington, Florida, Chicago Storm, Hurricane Hazel, etc.

The Rainfall Designer is displayed from the Time Series dialog box (see page 467) by selecting **STANDARD RAINFALL** from the **DATA TYPE** radio button group and then clicking the Rainfall Designer button, as shown in the following figure.

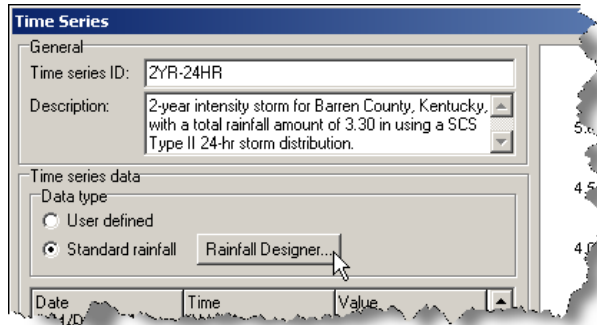

Figure 9.77 Clicking the Rainfall Designer button from the Time Series dialog box is used to access the Rainfall Designer

The Rainfall Designer, shown in the following figure, provides you with numerous options and flexibility for quickly defining the necessary design storms to be modeled.

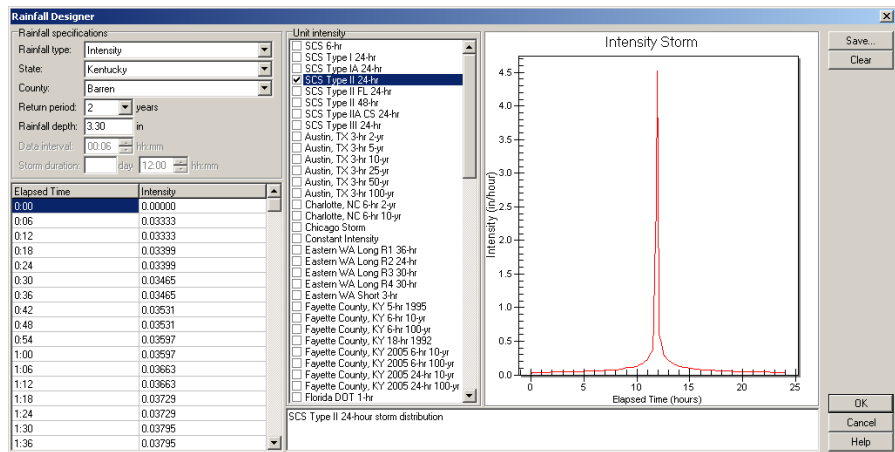

Figure 9.78 The Rainfall Designer allows you to select any location within the USA and it will provide the design rainfall for the specified storm frequency

To define a storm, choose the site location (i.e., state and county/metro area), return period, and storm distribution (i.e., unit intensity), and the software will retrieve the appropriate rainfall and display the rainfall distribution for the defined storm. Modification of any of the design parameters will cause the software to automatically update the rainfall distribution. Once you have defined an appropriate design storm, you can save it for later use on other projects by clicking Save. Later, the saved design storm can be loaded in the Time Series dialog box. Clicking Clear will clear out the currently defined design storm.

The following data are used to define a design storm:

Rainfall Type

This drop-down list allows you to choose the rainfall type (i.e., intensity or cumulative, as shown in the following figure) that you want the rainfall data generated for. After you have defined the necessary data for defining the design storm, you can change the rainfall type and the Rainfall Designer will automatically update the rainfall data.

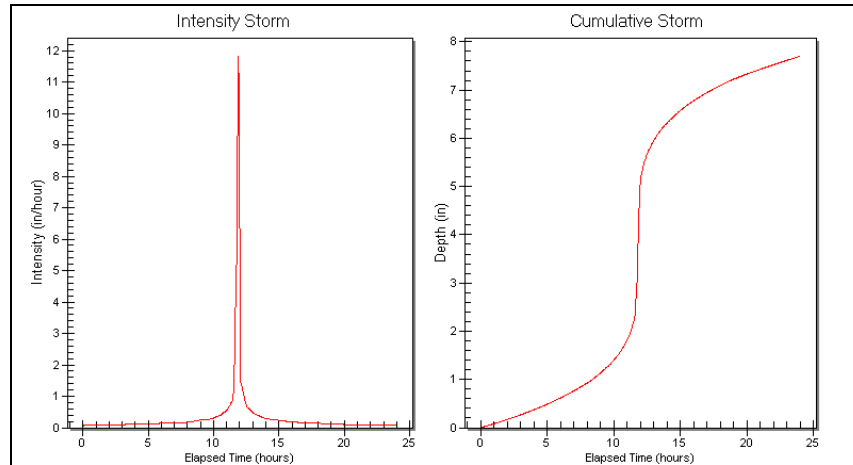

Figure 9.79 The Rainfall Designer allows you to quickly change the rainfall data from intensity to cumulative, as shown above

State

If working within the USA, select from the drop-down list the state (e.g., New Jersey, etc.) that the stormwater project is located within.

If you are not wanting the software to automatically retrieve rainfall data for the project location (or the project is outside of the USA), then leave this entry blank. You can then manually define the rainfall depth (total rainfall) to be analyzed.

County

After having selected the appropriate state, select from the drop list the county or major metropolitan area that the stormwater project is located within.

Return Period

After having selected the appropriate county or major metro area, select from the drop-down list the return period (i.e., 1-yr, 2-yr, 5-yr, 10-yr, 25-yr, 50-yr, or 100-yr) that you want to retrieve rainfall data from. Note that rainfall data for the 1-yr return period is not available for all states.

Rainfall Depth

Once you have selected a state, county (or major metro area), and a return period, the software will retrieve the corresponding rainfall depth from its rainfall database. If you want (or you are not using the included rainfall database), manually define the rainfall depth to be analyzed. You can also override the rainfall depth data that the software provides.

Data Interval

This field allows you to define the interval that should be used for creating the rainfall distribution. A typical data interval is 2 minutes.

Storm Duration

Some storm distributions, such as the Huff distribution, require that you define the storm duration. For example, the Huff distribution requires that you use different quartiles and corresponding storm duration to determine the *critical* design storm which causes the maximum amount of runoff for the site being analyzed. However, for most storm distributions, the storm duration is automatically determined by the Rainfall Designer and this field is then grayed out.

Unit Intensity

This check box list allows you to select the storm distribution (i.e., SCS Type II 24-hr, etc.) to be used. Only one storm distribution can be selected at a time. If multiple storms or storm distributions need to be analyzed, then simply define multiple time series—one time series for each storm or storm distribution.

Storm Distribution Details

Note that the Rainfall Designer will provide additional description and details regarding the selected storm distribution at the bottom of the dialog box.

Design Storm Description

Once you have completed the definition of the design storm in the Rainfall Designer and clicked OK, the rainfall data will be stored in the Time Series dialog box. In addition, a description of the design storm will be provided in the Time Series dialog box as shown previously in Figure 9.77.

Rainfall Database Accuracy

The rainfall database that is provided with the software is a compilation of different rainfall data from various federal, state, and local government sources. While this rainfall database is very comprehensive and we have endeavored to make certain that the data is accurate, the rainfall depth values that are retrieved should be cross-checked with local available data. If you find that the rainfall data provided with the software is not up-to-date for your area, please provide us with the correct rainfall data so that we can update the rainfall database for the next release of the software.

SCS Rainfall Distributions

The highest peak discharges from small watersheds in the United States are usually caused by intense, brief rainfalls that may occur as distinct events or as part of a longer storm. These intense rainstorms do not usually extend over a large area and intensities vary greatly. One common practice in rainfall-runoff analysis is to develop a synthetic rainfall distribution to use in lieu of actual storm events. This distribution includes maximum rainfall intensities for the selected design frequency arranged in a sequence that is critical for producing peak runoff.

The intensity of rainfall varies considerably during a storm as well as with geographic regions. To represent various regions of the United States, National Resource Conservation Service (NRCS, formerly the SCS) developed four synthetic 24-hour rainfall distributions (I, IA, II, and III) from available National Weather Service (NWS) duration-frequency data (*Hershfield 1061; Frederick et al., 1977*) or local storm data. Type IA is the least intense and type II the most intense short duration rainfall. The four different SCS 24-hour rainfall distributions are shown in Figure 9.80, and Figure 9.81 shows their approximate geographic boundaries.

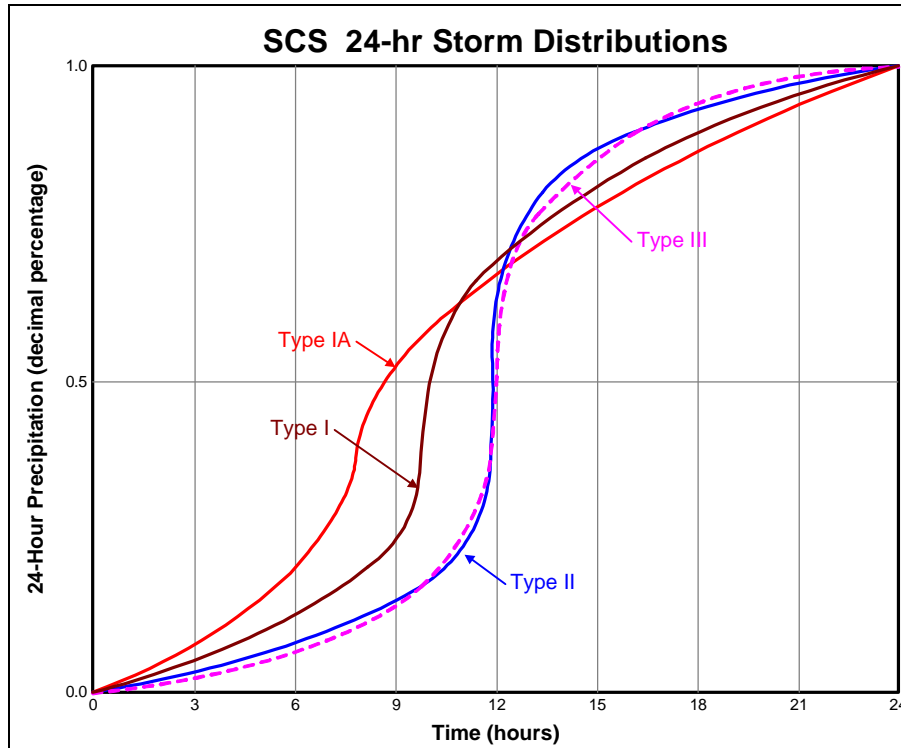

Figure 9.80 The SCS 24-hour rainfall distributions

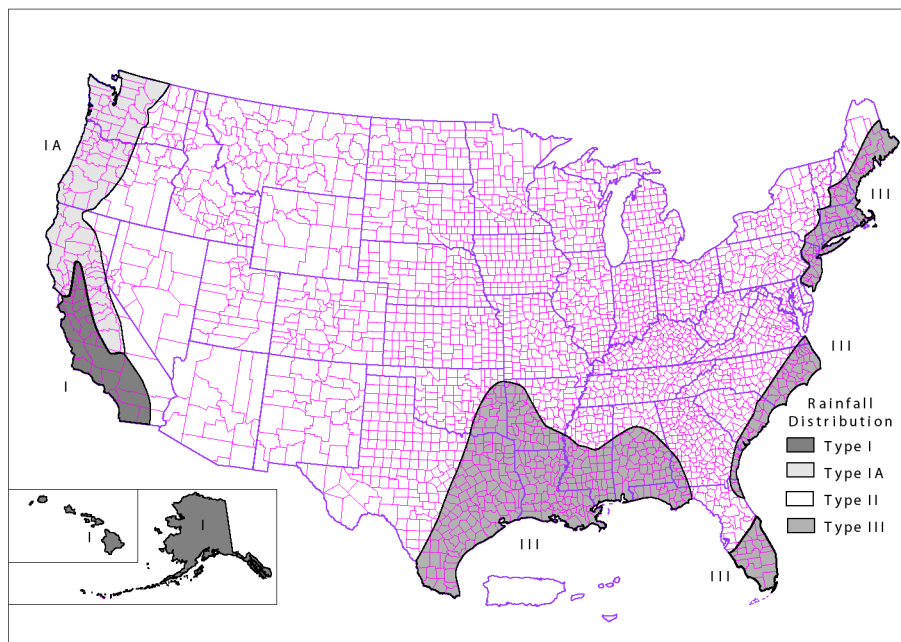

Figure 9.81 The SCS rainfall distribution geographic boundaries

From Figure 9.81, SCS Rainfall Distribution Types I and IA represent the Pacific maritime climate with wet winters and dry summers. Type III represents Gulf of Mexico and Atlantic coastal areas where tropical storms bring large 24-hour rainfall amounts. Type II represents the rest of the country.

Huff Rainfall Distributions

Other methods for estimating synthetic design storms are available. A well-known design storm method is based on the Huff synthetic hyetograph. This method uses a quartile-based storm pattern that categorized storms depending on whether the greatest percentage of total storm rainfall occurred in the first, second, third, or fourth quarter of the storm period.

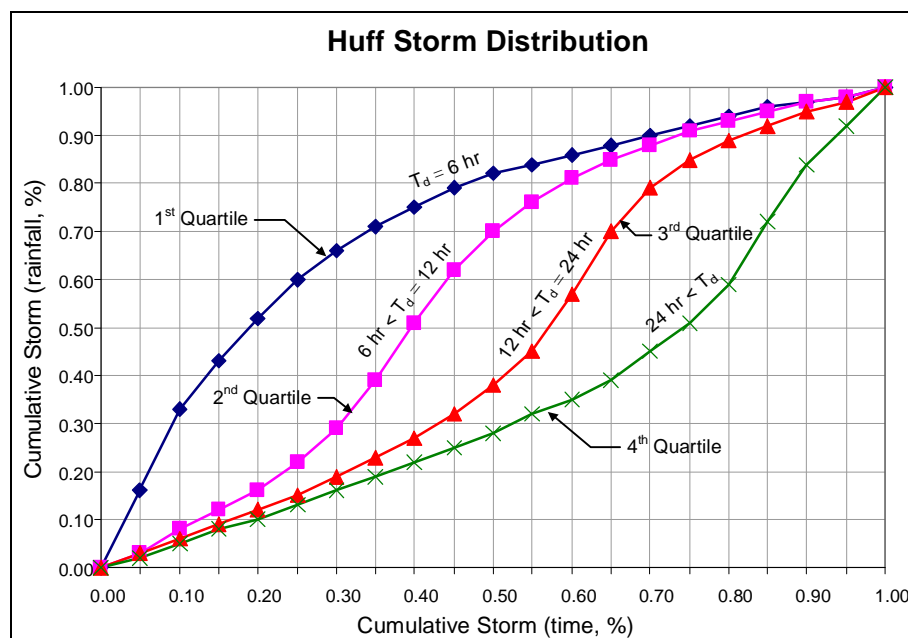

Figure 9.82 The Huff synthetic temporal distribution curves

Huff (1967) analyzed 12 years of rainfall data for 261 storms from 49 recording rain gages for a 400 square mile area in east-central Illinois. What is significant with regard to the developed synthetic design storm is that the study area was located in extremely flat prairie land with no significant topographic or urban influences on the local precipitation pattern.

Huff found that storms with durations of 6 hours or less showed a tendency to be associated more often with first-quartile storm distributions, those lasting from 6.1 to 12 hours were commonly associated with second-quartile distributions, those lasting 12.1 to 24 hours occurred most often with third-quartile distributions, and those storms with rainfall durations greater than 24 hours were most frequently associated with the fourth-quartile distribution. However, Huff stressed that specific storms among all rainfall durations could be associated with any of the four quartile types. This quartile distribution method was later built into the ILLUDAS computer model (which is used for storm sewer design) and the Huff rainfall distribution has found widespread use in the United States and Europe.

However, as with all synthetic methods, care should be applied when using the Huff rainfall distribution, since it can result in significantly different results from other methods and may not be accepted by review agencies.

Saving a Design Storm

Once you have defined an appropriate design storm, you can save it for later use on other projects by clicking Save. Later, the saved design storm can be loaded in the Time Series dialog box. Clicking Clear will clear out the currently defined design storm.

IDF Curves

When using the Rational, Modified Rational, and DeKalb Rational Methods, rainfall data is specified as an intensity (inches/hour or cm/hour) for a particular storm frequency (return period) and storm duration, rather than with a design storm (as is provided with the Rainfall Designer). IDF (Intensity Duration Frequency) curves, as shown in the following figure, provide a method for defining the rainfall intensity for a given storm frequency and storm duration. These rainfall intensities are generally specified by local governing agencies, having been previously computed from prior analysis of historical rainfall data.

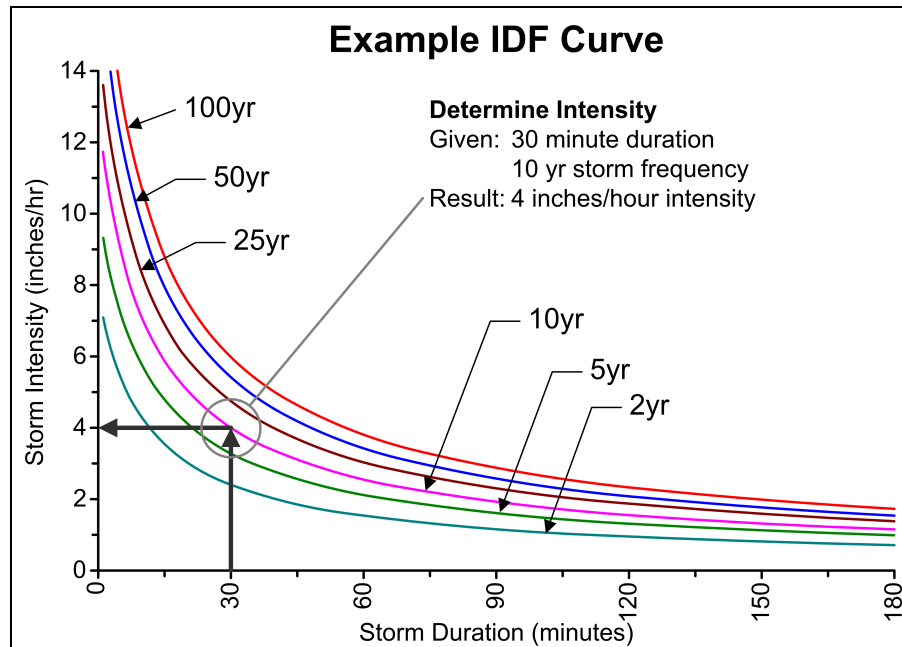

Figure 9.83 An example IDF curve, illustrating that given a 10-yr return period (storm frequency) and a 30 minute storm duration, the design rainfall intensity would be 4 inches/hour

The IDF Curves dialog box, shown in the following figure, provides you with numerous options and flexibility for defining rainfall intensity data. Select **INPUT** ► **IDF CURVES** or double-click the **IDF CURVES** icon from the data tree to display the IDF Curves dialog box. Note that the IDF Curves dialog box is only available if the Rational Method, Modified Rational Method, or DeKalb Rational Method hydrology method is selected from the **HYDROLOGY METHOD** drop-down list in the Project Options dialog box, General tab, described on page 166.

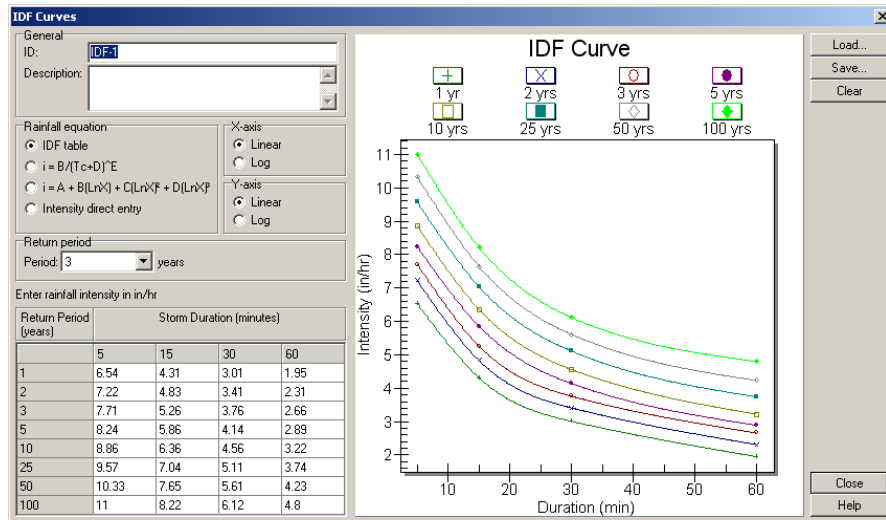

Figure 9.84 The IDF Curve dialog box allows you to define the intensity-duration-frequency (IDF) data for performing a Rational, Modified Rational, or DeKalb Rational Method hydrology method

The following data are used to define rainfall intensity data:

Intensity ID

Enter the unique name (or ID) that is to be assigned to the rainfall intensity data being defined. This name can be alphanumeric (i.e., contain both numbers and letters), can contain spaces, is case insensitive (e.g., ABC = abc), and can be up to 128 characters in length. Therefore, the assigned name can be very descriptive, to assist you in identifying different rainfall intensities.

Description (optional)

Enter an optional description that describes the rainfall intensity data being defined.

Rainfall Equation

From this radio button group, select the type of rainfall intensity data to be defined:

- IDF Table** Rainfall intensity data is defined by a table of storm durations (in minutes) versus return periods (in years). This is the most commonly used option.
- BDE Table** Rainfall intensity data is defined by a table of B-D-E coefficients versus return periods (in years) using the FWHA intensity equation.
- ABCD Table** Rainfall intensity data is defined by a table of third-degree polynomial coefficients A, B, C, and D versus return periods (in years).
- Intensity Direct Entry** Enter a single rainfall intensity that is to be analyzed.

X-Axis

Y-Axis

This radio button group allows you to specify the X and/or Y axis graduation as linear or logarithmic (log).

Storm Duration (IDF Table only)

These columns define rainfall intensity data (in inches/hour or cm/hour), corresponding to a particular storm duration (in minutes) versus return period (in years). As shown below in Figures 9.85 and 9.86, to add an additional storm duration column, right-click the table and select **INSERT STORM DURATION** from the displayed context menu. The Insert Storm Duration dialog box will then be displayed, allowing you to enter an additional storm duration to define rainfall intensity data for.

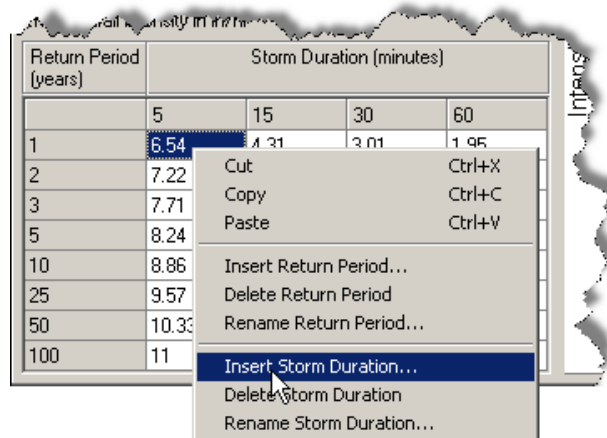

Figure 9.85 Right-click the table and click **INSERT STORM DURATION** to insert an additional storm duration column

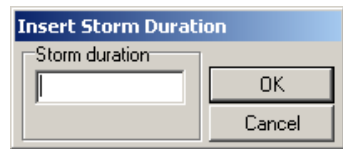

Figure 9.86 The Insert Storm Duration dialog box is then displayed, allowing you to enter an additional storm duration (in minutes) to define rainfall intensity data for

BDE (BDE Table only)

These columns define rainfall intensity data in terms of B-D-E coefficients used in the following FWHA intensity equation:

$$i = B / (T_c + D)^E$$

where:

T_c = time of concentration

The coefficients B, D and E are typically determined by plotting the existing rainfall intensity-duration curve(s) on log-log graph paper. The values B, D, and E can then be determined and directly entered into the software. Typically the initial plotted line is not straight. If it does plot straight, then $D = 0$. Otherwise, select a new trial constant for D (e.g., a value of 5). Add this constant to each of the T_c ordinates and re-plot the line. If the line is then straight, then $D = 5$. If the line is not straight, then try different constants until the line is straight. B is then the intensity at $T_c = 1$ while E is the slope of the plotted IDF line.

ABCD (ABCD Table only)

These columns define rainfall intensity data in terms of A-B-C-D polynomial coefficients used in the following third degree polynomial equation:

$$i = A + B(\ln X) + C(\ln X)^2 + D(\ln X)^3$$

where:

- i = intensity (in inches/hr or cm/hr)
- X = storm duration (X-axis) time ordinates

Return Period

These rows define rainfall intensity data (in inches/hour or cm/hour), corresponding to a return period (in years). As shown below in Figures 9.87 and 9.88, to add an additional return period row, right-click the table and select **INSERT RETURN PERIOD** from the displayed context menu. The Insert Return Period dialog box will then be displayed, allowing you to enter an additional return period to define rainfall intensity data for.

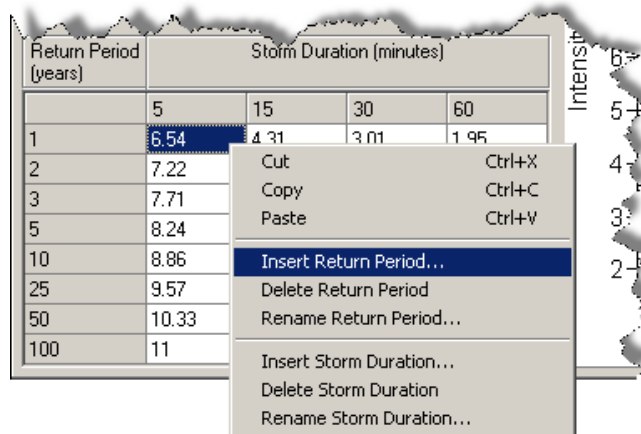

Return Period (years)	Storm Duration (minutes)			
	5	15	30	60
1	6.54	4.31	3.01	1.95
2	7.22			
3	7.71			
5	8.24			
10	8.86			
25	9.57			
50	10.33			
100	11			

Figure 9.87 Right-click the table and click **INSERT RETURN PERIOD** to insert an additional return period (storm frequency) column

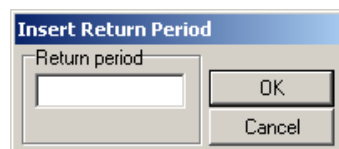

Figure 9.88 The Insert Return Period dialog box is then displayed, allowing you to enter an additional return period (in years) to define rainfall intensity data for

Intensity (Direct Intensity only)

In the event that IDF data is unavailable, you can directly enter the rainfall intensity (in inches/hour or cm/hour) to be analyzed.

Default Intensity Duration Frequency Data

Note that the software comes with its own default rainfall intensity data in order to demonstrate how to define this data. However, this data most likely *does not* correspond to your study area and you will need to override or replace this data with data specific to your project.



Saving Intensity Duration Frequency Data

Once you have defined an appropriate rainfall intensity data for a particular location, you can save it for later use on other projects by clicking the Save button. Later, the saved rainfall intensity data can be loaded back into the IDF Curves dialog box by clicking the Load button.

External Inflows

External inflows are additional flows that enter the conveyance network from other sources than drainage runoff. External inflows include:

- Rainfall dependent infiltrations/inflows (RDII)
- User-defined (direct) inflows
- Dry weather (sanitary) inflows

The External Inflows dialog box, shown below, allows you to define external inflows for any Junction, Outfall, Flow Diversion, Inlet, and Storage Node contained within the network. For example, this dialog box can be used to define the sanitary loading inflow data for an entire wastewater network model.

Select **INPUT** ► **EXTERNAL INFLOWS** or double-click the **EXTERNAL INFLOWS**  icon from the data tree to display the External Inflows dialog box.

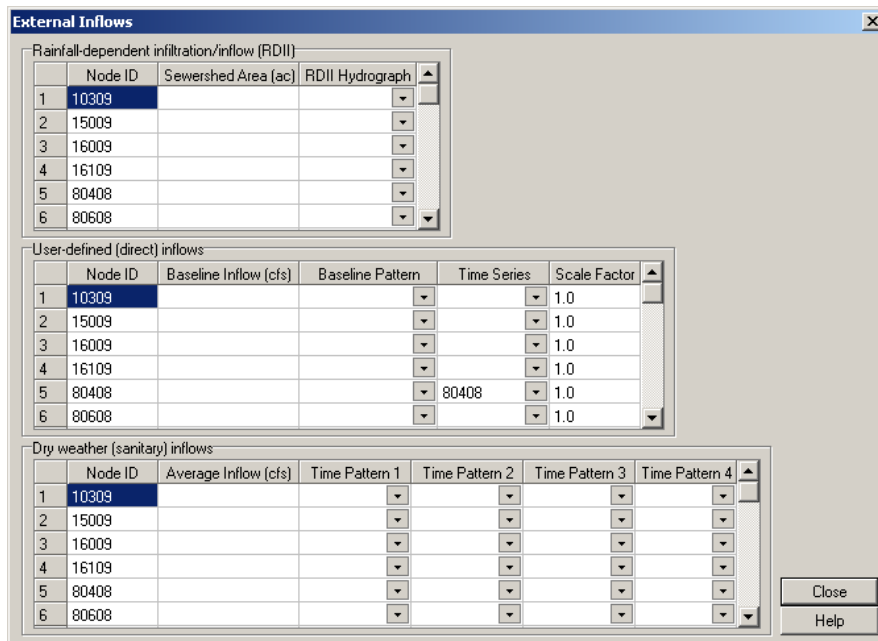

Figure 9.89 The External Inflows dialog box

Note that as you scroll up and down in one table within the dialog box, the other tables also scroll up and down by the same amount. This allows the three tables to remain synchronized, allowing you to easily view what external inflows are assigned to each node.

Network View vs. Node View

Although this dialog box is similar to the External Inflows for Node dialog box (see page 408), this dialog box provides you with the advantage of being able to define external inflows for any node within the network. The External Inflows for Node dialog box only allows external inflows to be defined at an individual node, one node at a time. However, the External Inflows for Node dialog box has the advantage of being able to assign pollutant inflows at a node, which this dialog box does not provide.

Rainfall-Dependent Infiltrations/Inflows (RDII)

The Rainfall-Dependent Infiltrations/Inflows section is used to specify rainfall dependent infiltrations/inflows entering a node of the network system.

Rainfall-dependent infiltrations/inflows (commonly abbreviated as RDII) are stormwater flows that enter sanitary or combined sewers due to “inflow” from direct connections of downspouts, sump pumps, foundation drains, etc. as well as “infiltration” of subsurface water through cracked pipes, leaky joints, poor manhole connections, etc. Rainfall-dependent infiltrations/inflows can be computed for a given rainfall record based on set of triangular unit hydrographs that determine a short-term, intermediate-term, and long-term inflow response for each time period of rainfall. Any number of unit hydrographs sets can be supplied for different drainage watershed areas and different months of the year.

The following data are used to define inflows:

Sewershed Area

Specify the area (in acres or hectares) of the sewershed that contributes RDII inflows for the node in question. Note this area is typically only a small, localized portion of the entire drainage subbasin area that contributes RDII inflows to the node.

RDII Unit Hydrograph

Select from the drop-down list the RDII unit hydrograph that applies to the node being defined. The RDII unit hydrograph is used in combination with the assigned rain gage to develop a time series of runoff inflow per unit area over the period of the simulation. See the section titled *RDII Unit Hydrographs* on page 411 for additional detail.

Leave this field blank to indicate that the node receives no RDII inflow.

User-Defined (Direct) Inflows

The User Defined (Direct) Inflows section is used to specify the time history of direct external inflow entering the node being defined. These inflows are represented by both a constant and time varying component as follows:

$$\begin{aligned} \text{Inflow at time } t = & (\text{baseline inflow}) \times (\text{baseline pattern factor}) \\ & + \\ & (\text{time series value at time } t) \times (\text{scale factor}) \end{aligned}$$

User-defined (or direct) inflows are added directly to a node. They can be used to perform flow routing in the absence of any runoff computations (as in a study area where no subbasins are defined). If modeling a river or stream, user-defined inflows can be used to define the baseflow.

The following data are used to define direct inflows:

Baseline Inflow (optional)

This column specifies the constant baseline component of the inflow. If this field is left blank, then no baseline inflow is assumed.

Baseline Pattern (optional)

This drop-down list defines an optional time pattern whose factors adjust the baseline inflow to vary in a periodic fashion by month of the year, by day of the week, and by time of day (for both weekdays and weekends). If this drop-down list is left blank, then the baseline inflow is not adjusted. A baseline time pattern is defined using the Sanitary Time Patterns dialog box, as described on page 464.

Time Series (optional)

This column provides a drop-down list item that allows you to select an already defined time series that contains the tabular data of time versus inflow for the selected constituent. If this entry is left blank, then no direct inflow will occur for the node being defined. A time series is defined using the Time Series dialog box, as described on page 467.

Scale Factor (optional)

This column specifies the multiplier to be used to adjust the values of the inflow time series. The baseline value is not adjusted by this factor. The scale factor can have several uses, such as allowing one to easily change the magnitude of an inflow hydrograph while keeping its shape the same without having to re-edit the entries in the hydrograph's time series. Or, it can allow a group of nodes sharing the same time series to have their inflows behave in a time-synchronized fashion while letting their individual magnitudes be different. If left blank, then the scale factor defaults to a value of 1.0.

Dry Weather (Sanitary) Inflows

The Dry Weather (Sanitary) Inflows section of the Inflows dialog box is used to specify a continuous source of dry weather flow entering the node being defined.

Dry weather inflows are continuous inflows that typically reflect the contribution from sanitary sewage in sewer systems or base flows in pipes and stream channels. They are represented by an average inflow rate that can be adjusted on a monthly, daily, and hourly basis by applying time pattern multipliers to this average value.

The following data are used to define dry weather inflow:

Average Inflow

Specify the average (or baseline) value of the dry weather inflow. Leave this field blank if there is no dry weather flow.

Time Pattern

From the drop-down list, select an already defined time pattern to be used to allow the dry weather flow to vary in a periodic fashion by month of the year, by day of the week, and by time of day (for both weekdays and weekends). Up to four different types of time patterns can be assigned—one for each time pattern type (i.e., Monthly, Daily, Hourly, Weekend). A time pattern is defined using the Sanitary Time Patterns dialog box, as described on page 464.

The actual dry weather inflow will equal the product of the average inflow value and any adjustment factors supplied by the specified time patterns, as shown below. If a time pattern is not supplied for one of the columns, the adjustment factor defaults to a constant value of 1.0.

$$\begin{aligned} \text{Inflow (at time } t) &= \text{Average Inflow} \\ &\times \\ &\text{Time Pattern 1 (value at time } t) \\ &\times \\ &\text{Time Pattern 2 (value at time } t) \\ &\times \\ &\text{Time Pattern 3 (value at time } t) \\ &\times \\ &\text{Time Pattern 4 (value at time } t) \end{aligned}$$

Typical Daily Average Flows

The following tables provide typical daily average flows for determining sanitary loadings.

Table 9.4 Typical daily average flows for determining sanitary loadings

Development	Units	Average Daily Flow (GPD/unit)	Average Daily Flow (LPD/unit)
Airport	Passenger	2.64	10.00
Apartment	Resident	68.68	260.00
Apartment Resort	Guest	58.12	220.00
Auditorium	Seat	5.00	18.93
Automobile Parking	1000 gross square feet	25.00	94.64
Automobile Service	Employee	13.21	50.00
Automobile Service	Vehicle	2.64	10.00
Bakery	1000 gross square feet	300.00	1135.62
Bar	Customer	2.11	8.00
Bar	Employee	13.21	50.00
Bar	Seat	20.00	75.71
Cabin Resort	Guest	42.47	160.00
Cafeteria	Customer	1.59	6.00
Cafeteria	Employee	10.57	40.00
Cafeteria	Seat	50.00	189.27
Campground	Guest	31.70	120.00
Car Wash (coin operated)	Stall	206.00	779.79
Car Wash (in bay)	5 GPM (peak flow)	412.00	1559.59
Church	Seat	5.00	18.93
Cocktail Lounge	Seat	19.81	75.00
Coffee Shop	Customer	5.28	20.00
Coffee Shop	Employee	10.57	40.00
Commercial	1000 gross square feet	100.00	378.54
Community Center	Occupant	5.00	18.93
Country Club	Employee	13.21	50.00
Country Club	Guest	105.67	400.00
Day Camp	Guest	13.21	50.00
Department Store	Employee	10.57	40.00
Department Store	Toilet	528.34	2000.00
Dining Hall	Meal served	7.93	30.00
Dog Kennel	1000 gross square feet	100.00	378.54
Dormitory	Guest	39.63	150.00
Gymnasium	1000 gross square feet	300.00	1135.62
Home (average)	Resident	73.97	280.00
Home (better)	Resident	81.89	310.00
Home (luxury)	Resident	100.39	380.00
Home (semi-modern)	Resident	52.83	200.00
Hospital (dog and cat)	1000 gross square feet	300.00	1135.62
Hospital (medical)	Bed	171.71	650.00
Hospital (medical)	Employee	10.57	40.00
Hospital (mental)	Bed	105.67	400.00
Hospital (mental)	Employee	10.57	40.00
Hotel	Employee	10.57	40.00
Hotel	Guest	50.19	190.00
Industrial Building	Employee	14.53	55.00
Jail	Inmate	85.00	321.76
Laboratory (commercial)	1000 gross square feet	300.00	1135.62
Laundromat	Wash	50.19	190.00
Laundromat	Washing machine	581.18	2200.00
Manufacturing (industry)	1000 gross square feet	100.00	378.54
Medical Building	1000 gross square feet	300.00	1135.62

Table 9.5 Typical daily average flows for determining sanitary loadings (continued)

Development	Units	Average Daily Flow (GPD/unit)	Average Daily Flow (LPD/unit)
Motel	Guest	31.70	120.00
Motel	Room	150.00	567.81
Motel (with kitchen)	Guest	52.83	200.00
Office	Employee	14.53	55.00
Office Building	1000 gross square feet	200.00	757.08
Prison	Employee	10.57	40.00
Prison	Inmate	118.88	450.00
Residential (1 bedroom apartment or condo)	Dwelling unit	150.00	567.81
Residential (2 bedroom apartment or condo)	Dwelling unit	200.00	757.08
Residential (3 bedroom apartment or condo)	Dwelling unit	250.00	946.35
Residential (artist dwelling)	Dwelling unit	100.00	378.54
Residential (artist dwelling, 2/3 area)	1000 gross square feet	300.00	1135.62
Residential (bachelor/single)	Dwelling unit	100.00	378.54
Residential (boarding house)	Bed	85.00	321.76
Residential (duplex)	Dwelling unit	300.00	1135.62
Residential (guest house with kitchen)	Dwelling unit	330.00	1249.19
Residential (mobile home)	Home space	200.00	757.08
Residential (single family dwelling)	Dwelling unit	330.00	1249.19
Residential (townhouses, set grade)	Dwelling unit	330.00	1249.19
Resort	Guest	52.83	200.00
Rest Home	Employee	10.57	40.00
Rest Home	Resident	92.46	350.00
Restaurant	Meal served	2.64	10.00
Restaurant (fixed seat)	Seat	50.00	189.27
Restaurant (take out)	1000 gross square feet	300.00	1135.62
Retail Area	1000 gross square feet	100.00	378.54
Rooming House	Resident	39.63	150.00
School (boarding)	Student	73.97	280.00
School (day care center)	Child	10.00	37.85
School (elementary / junior high)	Student	10.00	37.85
School (high school)	Student	15.00	56.78
School (kindergarten)	35 gross square feet	10.00	37.85
School (large)	Student	21.13	80.00
School (medium)	Student	15.85	60.00
School (small)	Student	10.57	40.00
Shopping Center	Employee	10.57	40.00
Shopping Center	Parking space	1.06	4.00
Summer Cottage	Guest	50.19	190.00
Swimming Pool	Customer	10.57	40.00
Swimming Pool	Employee	10.57	40.00
Theater	Customer	2.64	10.00
Theater (fixed seat)	Seat	5.00	18.93
Trailer Park	Resident	39.63	150.00
Video Center	Customer	5.28	20.00

References

1. Ciceron, F., 2004, Sanitary Sewer Design Guidelines, City of Oakland, Public Works Agency, Oakland, California
2. Tchobanoglous, G. and Metcalf & Eddy, 1981, Wastewater Engineering: Collection and Pumping of Wastewater, McGraw-Hill, Columbus, Ohio

The following data are used to define inflows:

RDII Unit Hydrograph

Select from the drop-down list the RDII unit hydrograph that applies to the node being defined. The RDII unit hydrograph is used in combination with the assigned rain gage to develop a time series of runoff inflow per unit area over the period of the simulation.

Leave this field blank to indicate that the node receives no RDII inflow.

Click the browse button to display the RDII Unit Hydrographs dialog box, described on page 411, to define a new RDII unit hydrograph.

Sewershed Area

Specify the area (in acres or hectares) of the sewershed that contributes RDII inflows for the node in question. Note this area is typically only a small, localized portion of the entire drainage subbasin area that contributes RDII inflows to the node.

User-Defined (Direct) Inflows

The User Defined (Direct) Inflows section is used to specify the time history of direct external inflow and pollutant inflows entering the node being defined. These inflows are represented by both a constant and time varying component as follows:

$$\begin{aligned} \text{Inflow at time } t = & \text{ (baseline inflow) } \times \text{ (baseline pattern factor)} \\ & + \\ & \text{ (time series value at time } t) \times \text{ (scale factor)} \end{aligned}$$

User-defined (or direct) inflows are added directly to a node. They can be used to perform flow and water quality routing in the absence of any runoff computations (as in a study area where no subbasins are defined). If modeling a river or stream, user-defined inflows can be used to define the baseflow.

The following data are used to define direct inflow:

Constituent

This read-only column provides a list of **FLOW** and previously defined pollutant constituents whose direct inflow is to be defined.

If a pollutant is assigned a user-defined inflow in terms of concentration, then one must also assign a user-defined inflow to the **FLOW** constituent, otherwise no pollutant inflow will occur. An exception is at submerged outfalls where pollutant intrusion can occur during periods of reverse flow. If pollutant inflow is defined in terms of mass, then a user-defined inflow to the **FLOW** constituent is not required.

Baseline Inflow (optional)

This column specifies the constant baseline component of the pollutant constituent's inflow. For **FLOW**, the units are the project's flow units. For pollutants, the units are the pollutant's concentration units if inflow is a concentration, or can be any mass flow units if the inflow is a mass flow (see **CONVERSION FACTOR** data entry, below). If this field is left blank, then no baseline inflow is assumed.

Baseline Pattern (optional)

This drop-down list defines an optional time pattern whose factors adjust the baseline inflow to vary in a periodic fashion by month of the year, by day of the week, and by time of day (for both weekdays and weekends). If this drop-down list is left blank, then the baseline inflow is not adjusted. Click the browse button to display the Sanitary Time Patterns dialog box, described on page 464, to define a new time pattern.

Time Series (optional)

This column provides a drop-down list item that allows you to select an already defined time series that contains the tabular data of time versus inflow for the selected constituent. If this entry is left blank, then no direct inflow will occur for the selected constituent for the node being defined. Click the browse button to display the Time Series dialog box, which is described on page 467, to define a new direct inflow time series.

Scale Factor (optional)

This column specifies the multiplier to be used to adjust the values of the pollutant constituent's inflow time series. The baseline value is not adjusted by this factor. The scale factor can have several uses, such as allowing one to easily change the magnitude of an inflow hydrograph while keeping its shape the same without having to re-edit the entries in the hydrograph's time series. Or, it can allow a group of nodes sharing the same time series to have their inflows behave in a time-synchronized fashion while letting their individual magnitudes be different. If left blank, then the scale factor defaults to a value of 1.0.

Inflow Type

For pollutant constituents, the drop-down list allows you to select the type of inflow data contained in the specified time series data as either concentrations or mass inflows. This field is not available for the **FLOW** inflow row.

Conversion Factor

For pollutant constituents, this entry is used to define the numerical conversion factor for converting a pollutant mass flow rate in the time series data into concentration times flow units. This field is not available for the **FLOW** inflow row.

For example, if the time series data is in pounds per day and the pollutant concentration defined for the project is in mg/L while the flow units are CFS, then the conversion factor is $(453590 \text{ mg/lb}) / (86400 \text{ sec/day}) = 5.25 \text{ (mg/sec) per (lb/day)}$.

Dry Weather (Sanitary) Inflows

The Dry Weather (Sanitary) Inflows section of the Inflows dialog box is used to specify a continuous source of dry weather flow entering the node being defined.

Dry weather inflows are continuous inflows that typically reflect the contribution from sanitary sewage in sewer systems or base flows in pipes and stream channels. They are represented by an average inflow rate that can be adjusted on a monthly, daily, and hourly basis by applying time pattern multipliers to this average value.

The following data are used to define dry weather inflow:

Constituent

This read-only column provides a list of **FLOW** and previously defined pollutant constituents whose dry weather inflow is to be defined.

Average Inflow

Specify the average (or baseline) value of the dry weather inflow of the constituent in the relevant units (e.g., flow units for **FLOW** constituent, concentration units for pollutant constituent). Leave this field blank if there is no dry weather flow for the selected constituent.

Time Pattern

From the drop-down list, select an already defined time pattern to be used to allow the dry weather flow to vary in a periodic fashion by month of the year, by day of the week, and by time of day (for both weekdays and weekends). Up to four different types of time patterns can be assigned—one for each time pattern type (i.e., Monthly, Daily, Hourly, Weekend). Click the browse button to display the Sanitary Time Patterns dialog box, described on page 464, to define a new time pattern.

RDII Unit Hydrographs

RDII unit hydrographs (UHs) estimate rainfall-dependent infiltration/inflow into a sanitary or combined sewer system. A UH group can have up to 12 UH sets, one for each month of the year. Each UH group is considered as separate and is assigned its own unique name along with the name of the rain gage that supplies rainfall data to it.

Each RDII unit hydrograph, as shown in the following figure, is defined by three parameters:

- R , the percentage of rainfall that enters the sanitary sewer system as RDII
- T , the time from the onset of rainfall to the peak of the UH, in hours
- K , the ratio of time to recession of the UH to the time to peak

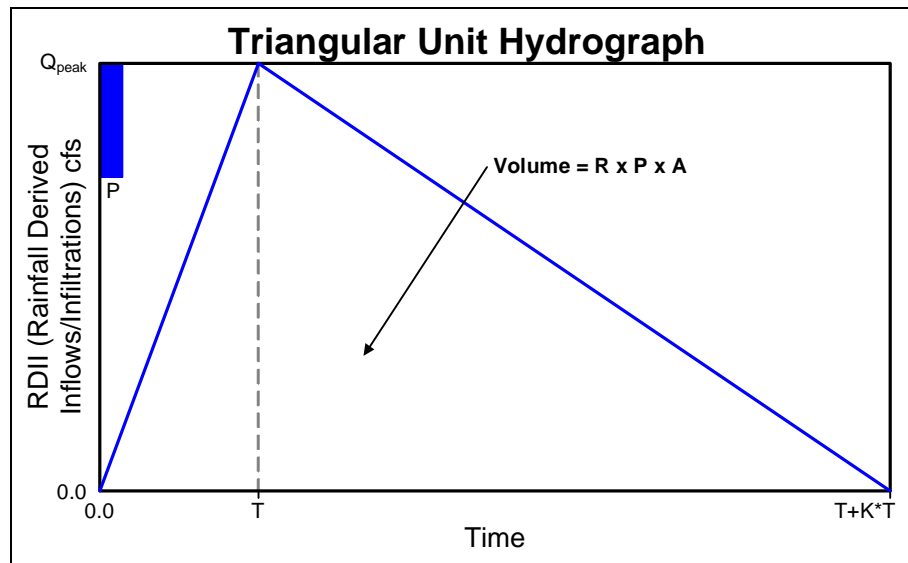

Figure 9.91 The triangular unit hydrograph, generated by the RTK parameters

A UH set contains up to three such hydrograph responses (or components):

- Short term (or rapid)
- Medium term (or intermediate)
- Long term

Each unit hydrograph response (or component) is modeled as a triangular shaped hydrograph, all beginning at the same time and each having its own R, T and K parameters. R values are defined such that:

$$R = R_1 + R_2 + R_3$$

where:

- R = fraction of total rainfall entering the sewer network
- R_1, R_2, R_3 = fraction of total rainfall entering sewer network in the short, intermediate, and long term unit hydrographs

At any time, the total RDII is the sum of the three component unit hydrographs, as shown in the following figure.

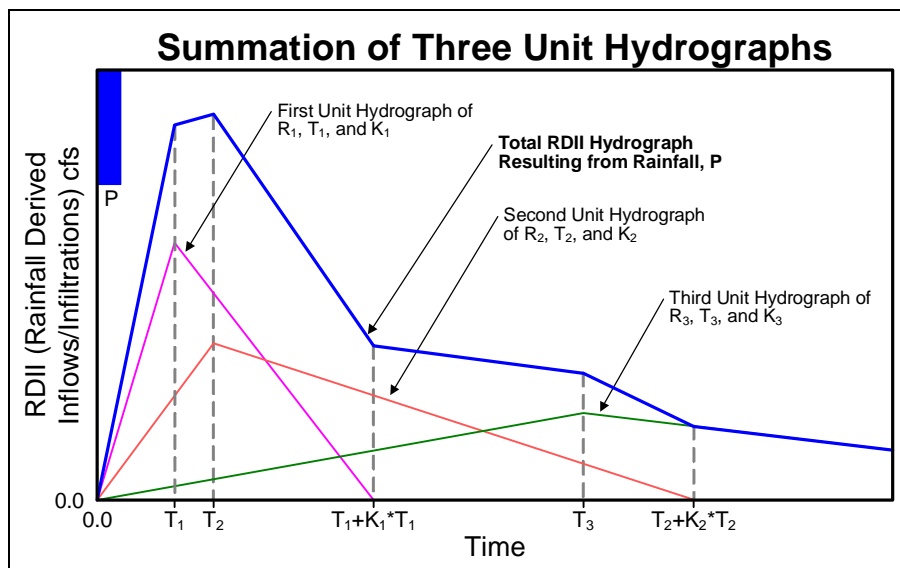

Figure 9.92 Composite RDII hydrograph, generated using the sum of the three component unit hydrographs for short-term, intermediate, and long-term response

To generate rainfall-dependent infiltration/inflow to a drainage system node, the node must identify the UH group and the area of the surrounding watershed that contributes rainfall-dependent infiltration/inflow.

The RDII Unit Hydrographs dialog box, as shown in the following figure, is used to specify the parameters defining RDII unit hydrographs for computing rainfall-dependent infiltration/inflow. To display the RDII Unit Hydrographs dialog box, choose **INPUT ► RDII UNIT HYDROGRAPHS**.

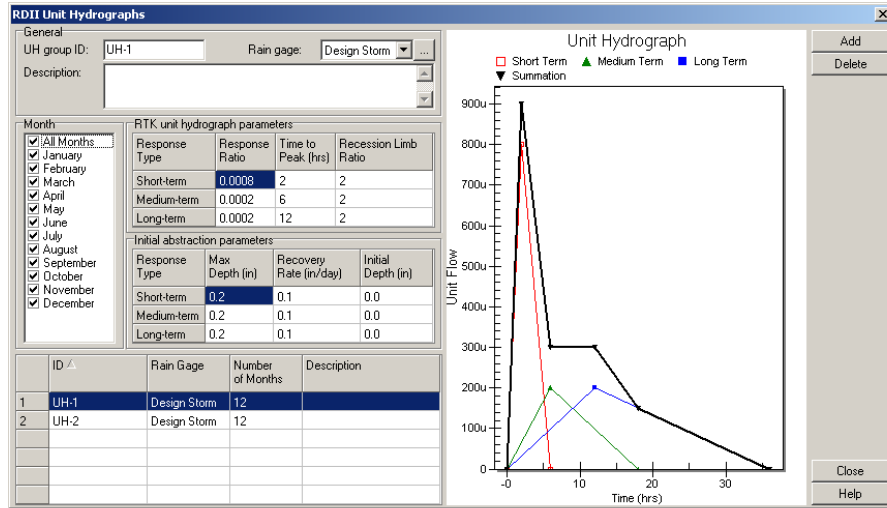

Figure 9.93 The RDII Unit Hydrographs dialog box

The RDII Unit Hydrographs dialog box is used to specify the shape parameters and rain gage for a group of triangular unit hydrographs. These hydrographs are used to compute rainfall-dependent infiltration/inflow at selected junction nodes of the drainage system. A unit hydrograph “group” can contain up to 12 sets of individual unit hydrographs (one for each month of the year), and each set (each month) can consist of up to 3 individual unit hydrographs (for short-term, medium-term, and long-term responses, respectively).

To select a unit hydrograph group, scroll through the displayed table and click the row containing the unit hydrograph group of interest. The provided data entry fields will then display information describing the selected unit hydrograph group. To add a new unit hydrograph group, click the Add button and then enter the appropriate information in the data fields. To delete a unit hydrograph group, select the unit hydrograph group from the table and then click the Delete button.

The following data are used to define a unit hydrograph:

UH Group ID

Enter the unique name (or ID) that is to be assigned to the unit hydrograph group being defined. This name can be alphanumeric (i.e., contain both numbers and letters), can contain spaces, is case insensitive (e.g., *ABC = abc*), and can be up to 15 characters in length. Therefore, the assigned name can be very descriptive, to assist you in identifying different unit hydrograph groups.

Description (optional)

Enter an optional description that describes the unit hydrograph data being defined.

Rain Gage

Select from the drop-down list an already defined rain gage that supplies rainfall data to the unit hydrographs in the group. Click the browse button to display the Rain Gages dialog box, described on page 388, to define a new rain gage.

Month

Select a month from the list box for which hydrograph parameters will be defined. Select **ALL MONTHS** to specify a default set of hydrographs that apply to all months of the year. Then select specific months that need to have special hydrographs defined.

RTK Unit Hydrograph Parameters

The RTK Unit Hydrograph Parameters section describes for each unit hydrograph group a set of R-T-K parameters that define the magnitude and shape of the unit hydrograph.

Response Ratio (R)

The column defines the fraction (decimal percentage) of rainfall volume that enters the sewer system. This value is commonly referred to as the *R* parameter, and is used to define the shape of the unit hydrograph. This value cannot be negative. In addition, the sum of the response ratios for the short-term, intermediate-term, and long-term UH responses should not exceed 1.0 (and should rarely equal 1.0, except for special cases).

Time to Peak (T, hrs)

The column defines the time from the onset of rainfall to the peak of the unit hydrograph (in hours). This value is commonly referred to as the *T* parameter, and is used to define the shape of the unit hydrograph.

Recession Limb Ratio (K)

The column defines the ratio of time to recession (decimal percentage) of the unit hydrograph to the time to peak. This value is commonly referred to as the *K* parameter, and is used to define the shape of the unit hydrograph.

Short Term

This row is used to specify parameters for a short-term response unit hydrograph (i.e., small value of *T*). Leave this row blank if not defining a short-term response unit hydrograph for a particular month.

Medium Term

This row is used to specify parameters for an intermediate-term response unit hydrograph (i.e., medium value of *T*). Leave this row blank if not defining an intermediate-term response unit hydrograph for a particular month.

Long Term

This row is used to specify parameters for a long-term response unit hydrograph (i.e., largest value of *T*). Leave this row blank if not defining a long-term response unit hydrograph for a particular month.

Initial Abstraction Parameters

The Initial Abstraction Parameters section describes for each unit hydrograph group a set of Initial Abstraction (IA) parameters that are associated with it. These parameters determine how much rainfall is lost to interception and depression storage before any excess rainfall is generated and transformed into RDII (Rainfall Dependent Inflow/Infiltration) flow by the unit hydrograph. Different initial abstraction parameters can be assigned to each of the three unit hydrograph responses.

Maximum Depth

The column defines the maximum possible depth of the initial abstraction (in inches or mm).

Recovery Rate

The column defines the recovery rate (in inches/day or mm/day) at which stored initial abstraction is depleted during dry periods.

Initial Depth

The column defines the initial depth of stored initial abstraction (in inches or mm).

Short Term

This row is used to specify parameters for a short-term response initial abstraction (i.e., small value of T). Leave this row blank if not defining a short-term response initial abstraction for a particular month.

Medium Term

This row is used to specify parameters for an intermediate-term response initial abstraction (i.e., medium value of T). Leave this row blank if not defining an intermediate-term response initial abstraction for a particular month.

Long Term

This row is used to specify parameters for a long-term response initial abstraction (i.e., largest value of T). Leave this row blank if not defining a long-term response initial abstraction for a particular month.

Sources of RDII

The following figure shows the RDII (Rainfall-Dependent Inflow/Infiltration) flow in a sanitary sewer system. This figure clearly shows the additional sewer inflow caused by rainfall within the sewershed. The increased flows can contribute to sanitary sewer overflows (SSO) and increased flows at the wastewater treatment plant.

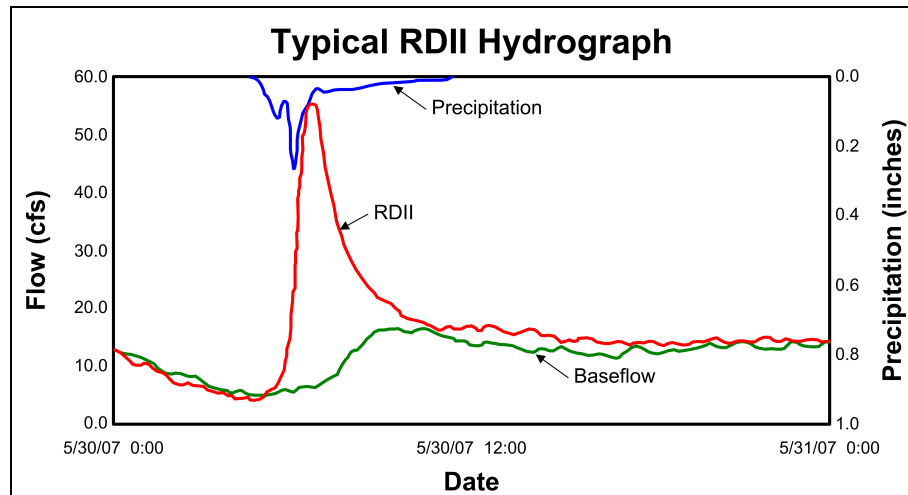

Figure 9.94 Example of a typical RDII and base flow hydrograph

A sanitary sewer's capacity can be exceeded during wet weather due to additional inflows and infiltrations into the sanitary sewer. This can cause surcharging and potentially overflowing of the sewers. In addition, sewer capacity can be reduced by root intrusion, grease build-up, sedimentation, and debris. Figures 9.95 and 9.96, below, show infiltration into a sanitary sewer system.



Figure 9.95 Example of infiltration into a sanitary sewer network (courtesy City of Surrey, Canada)



Figure 9.96 Example of infiltration into a sanitary sewer network (courtesy City of Surrey, Canada)

RDII Parameter Determination and Calibration

Calibration of the model is the only practical way to assure that the assigned RDII parameter values accurately represent the wastewater system being modeled.

Model calibration consists of adjusting selected input parameters so that the computed output matches the observed monitoring results at key points in the system. Upon completion, the calibrated model should provide a good match between predicted and observed results when applied to storm events not used in the calibration process. When this criterion is met, the model is considered validated or verified.

Model Validation Criteria

In general, model validation is concerned with comparison of the computed and measured flow hydrographs. It is recommended to establish some sort of validation criteria to measure the accuracy of the model. These criteria can include:

- Peak discharge values
- Flow volumes
- Graphical shape
- Time of peak
- Accumulated flow differences

In order to validate the computed discharge time series, it is recommended that the data be exported into Microsoft Excel spreadsheet (or some other software) for further processing and comparison with measured time series.

Flow Monitoring and Measurements

Model calibration requires corresponding rainfall and sewer network flow measurements for a number of storm events. Rainfall data should be obtained from one or more gages located in or close to the drainage area. Flow monitoring should be conducted at representative locations in the sewershed collection system. Monitoring of overflows at the largest flow points in the system is advisable. Even the best model predictions are only approximations of reality, and emphasis on the largest flows will help to secure the best accuracy for the most significant discharges and the best overall estimate of flow volumes and wastewater loads for the collection system. In addition to overflows, flow monitoring stations should be located at one or more points in the collection system upstream of any flow regulators. This is necessary to calibrate the model parameters defining the contributing drainage area that control the conversion of rainfall into RDII into the collection system.

The amount of measured discharge and precipitation data, along with its resolution has an impact in the accuracy and credibility of the obtained RDII parameter values. An adequate number of storm events (usually 5 to 10) should be monitored and used in the calibration. This is important because of possible malfunctions in different flow sensors at different times, and also to compensate for variations in rainfall distribution over the drainage area. The point rainfall measurement at the rain gage provides only an approximation of the storm distribution over the entire drainage area, so variations in individual events should be expected.

The availability of sufficient number of different storm events will also facilitate and improve the model calibration. Many users prefer to base the calibration on the model's ability to reproduce the overall results from a number of different events, rather than attempt to match instantaneous flow measurements.

Ideally, long time series of measured discharge data with daily values is required for calibration of RDII parameters. Several months of higher resolution time series data (i.e., minutes or hours) is required to calibrate the surface runoff model.

Shorter time series data sets may also be useful, but should not be used exclusively to generate RDII parameter values.

Generally, performing a continuous, long-term analysis to look at periods of both wet and dry weather, rather than a hydrological load analysis of the sewer system for only a short period of high intensity rain storms, provides a more accurate representation of actual loads on wastewater treatment plants and sewer overflows.

Flow measurements almost always will be made using automatic sensing units, but it is important to provide periodic inspection and supervision. Sensors tend to clog and generate erroneous readings, which can seriously impede model calibration efforts if left undetected.

In addition to timely maintenance to the flow meters, operational supervision can also assure that the location being monitored is not surcharged at the time of flow measurements. The existence of a surcharged condition is essential information for reliable application of the model.

Routing Method Selection

If sewer pipes can surcharge, then hydrodynamic routing must be used rather than kinematic wave routing. This adds some complexity to the model analysis, not so much in the computations, but in the model's sensitivity to the accuracy of the assigned input data. When hydrodynamic routing is used, a more accurate definition of the sewer collection model is required (i.e., pipe diameters, slopes, lengths, etc.).

Computational Time Steps

RDII (dry weather) computations are often performed with relative long time steps (several hours) whereas surface runoff (wet weather) computations are typically performed with much shorter time steps (several minutes). These time step values are defined in the Analysis Options dialog box (see page 69 for more details). When performing continuous simulation modeling, the dry weather time step should be chosen in accordance with the resolution of the precipitation data. For example, if only daily precipitation data is available, then a dry weather time step of 24 hours would be suitable. However, in the event that precipitation data is available with high resolution (e.g., few minutes), then the dry weather time step should be selected in accordance to the response of the RDII discharge response during the storm event (e.g., 2 to 4 hours). To minimize computational simulation time as well as limit the size of the analysis output files, the dry weather simulation is computed continuously for the entire simulation period, whereas the wet weather simulation is computed only when precipitation occurs and continues until all the surface runoff hydrographs have returned to approximately zero discharge.

RDII Determination for Large Network Systems

Applying the model is more cumbersome for collection systems with many regulators and overflow points. For large or complex systems, practical maximum lengths are generally 1 year or less, and in some cases could be less than a 6-month simulation period. When the period being analyzed is short, it is important that the most appropriate period of the rain record be selected for analysis, so that the model provides representative projections of the collection system. Independent analysis of rain data can assist in selecting an appropriate portion of the overall rainfall record to analyze.

Initial RDII Parameters

It can be very time consuming to estimate the RDII parameters and adjust them to match monitored data. There is generally a wide range of RDII rates, depending upon the age of the sewer system and the type of underlying soil. For new sewer systems, sanitary flows are best estimated by the development of the drainage area (i.e., population, industries, etc.). Wet weather inflow for an existing system can generally be accounted for during calibration by adjusting the drainage area of the sewersheds to account for that fraction of the total area that contributes wet weather flow.

For example, for well constructed sewers, one could start with an assumption that 5% of the total drainage area generated RDII. However, to provide a meaningful comparison with monitoring flow meters, the sewered area being analyzed should, at a minimum, exclude large unsewered areas such as park lands, golf courses, stream valleys, highways, cemeteries, etc. Only those areas that can act as effective sources of RDII into the system should be included in the analysis.

Calibration Steps

It is not possible to determine RDII parameter values from geophysical measurements, since most parameters are empirical. Therefore, it is necessary that the RDII parameters be determined by comparison between simulated and measured discharges through a calibration process.

A preliminary calibration can be performed visually by comparing the simulated and measured discharges. Optimization of the RDII parameters is then performed by iterative adjustment. However, during the optimization process, it may be necessary to return to a previous calibration step. It is recommended, especially for less experienced users, that only one RDII parameter should be changed at a time during each iteration cycle, so that the effect of the adjustment can be clearly be seen. However, sometimes the effect of changing one parameter may not be sufficient. In this case, two (or more) parameters may need to be adjusted at the same time.

The unit hydrograph parameters that need to be adjusted for the short term (or rapid), medium term (or intermediate), and long term responses are:

- Response Ratio (R)
- Time to Peak (T, hrs)
- Recession Limb Ratio (K)

The short-term response unit hydrograph should tend to be nearly an exact reflection of the rainfall hyetograph, since this inflow tends to be from direct connections from surface runoff to the sewer system. This direct connection inflow can occur from broken pipes, incorrectly connected sewer pipes, partially open manhole covers, etc. This unit hydrograph tends to be the most critical to calibrate for, since it tends to be the dominant volume of RDII that can overwhelm a sanitary sewer system. To determine sources of short-term RDII, physical inspection methods such as smoke testing and remote camera inspection may be necessary. Along with this information, one can then compare responses of the sewer system with specific rainfall events to calibrate the short-term response unit hydrograph.

The following steps are recommended for calibrating a model:

- 1 Start by adjusting the RDII contributing drainage area to calibrate the water balance so that the computed and measured total volume during the observation period closely matches, as shown in the following figure. Increasing the RDII contributing drainage area should proportionally increase the RDII flow volume.

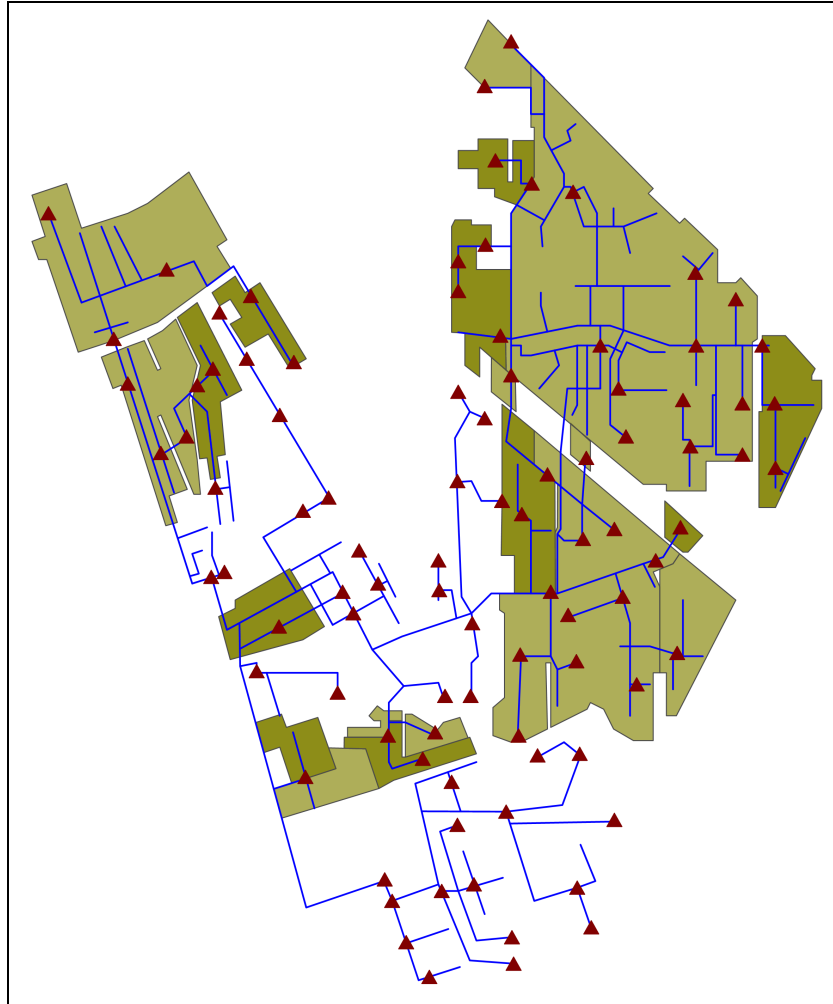

Figure 9.97 RDII contributing areas

- 2 Next, adjust the response ratio (R) for the short-term, intermediate-term, and long-term response unit hydrographs so that the correct distribution of RDII peak flows and wastewater base flows approximately match the measured flows. This should be typically done after a wet period (i.e., saturated soils) and preferably for a period with low evapotranspiration.
- 3 Adjust the time to peak (T) for the short-term, intermediate-term, and long-term response unit hydrographs so that the RDII peak flow and measured peak flow approximately match.
- 4 Adjust the recession limb ratio (K) for the short-term, intermediate-term, and long-term response unit hydrographs so that the shape of the resultant RDII flow hydrograph matches that with the measured wastewater flow hydrograph.

Extrapolating Calibrated Model Concerns

Standard practice is typically to take several low intensity, low volume storm events from a limited flow measurement period and extrapolate this input data to the design storm of much higher intensity and volume. However, care must be exercised since this method can overstate potential RDII volumes and rates by not considering the hydraulic capacity of the collection system. The hydraulic limit may occur at intensities or volumes that are much lower than the design event. The software has the ability to determine the maximum capacity of the collection system under junction flooding conditions (unless the junction surcharge values are set to very high elevations to simulate bolted manhole covers).

Additional RDII References

Additional publications that discuss the analysis of RDII include the following documents.

- “Combined Sewer Overflow Control Manual,” US EPA, September 1993, EPA/625/R-93/007
- “Sewer System Infrastructure Analysis and Rehabilitation Handbook,” US EPA, October 1991, EPA/625/6-91/030

Dimensionless Unit Hydrograph

The dimensionless unit hydrograph, as shown in the following figure, is one of several watershed related parameters incorporated into NRCS (SCS) hydrologic modeling procedures. The unit hydrograph influences the shape of the runoff hydrograph generated by the model, particularly the peak rate of discharge. It does not affect the volume of runoff (which is determined by curve number).

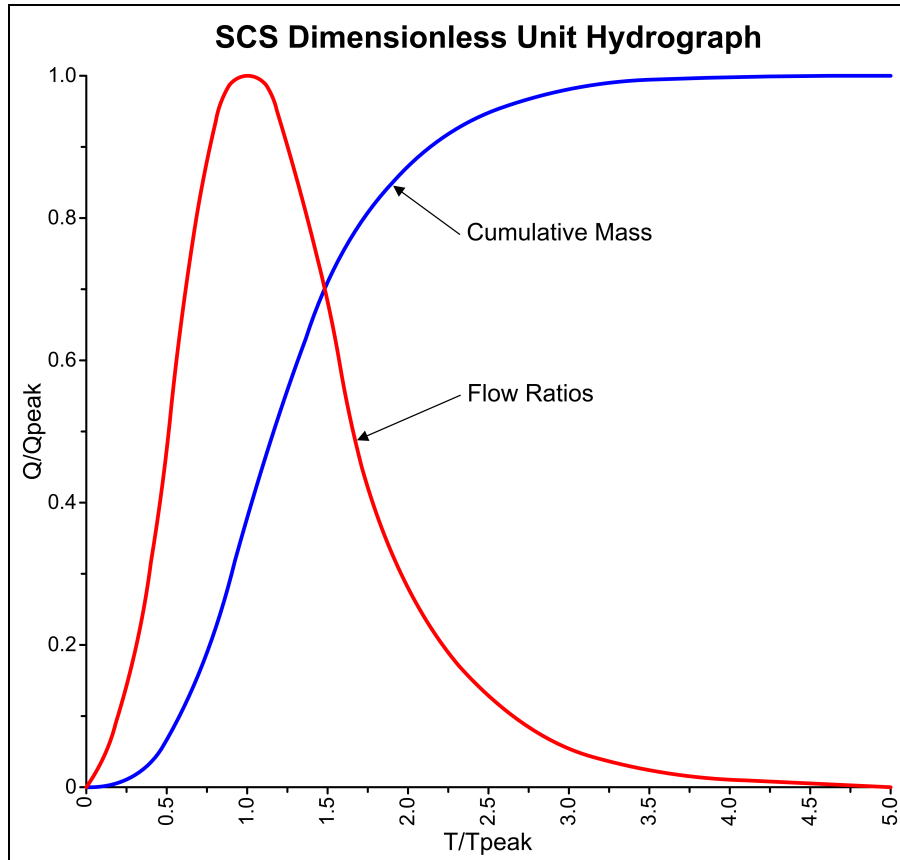

Figure 9.98 A typical SCS dimensionless unit hydrograph

A unit hydrograph's shape varies by watershed based on many factors, including:

- Watershed size, slope, and length
- Geomorphic and geologic characteristics
- Amount of storage
- Degree of urbanization

The software uses the default SCS dimensionless unit hydrograph (corresponding to a 484 peaking factor), which represents an average condition for much of the country. This is generally sufficiently accurate for the hydrologic analysis and so you do not need to adjust the dimensionless unit hydrograph.

Detailed studies, however, have been conducted in some watersheds and regions to develop more representative dimensionless unit hydrographs. The software allows you to define these unique unit hydrographs, as well as provides several standard unit hydrographs used in different parts of the country. The following figure shows a comparison between two different dimensionless unit hydrographs.

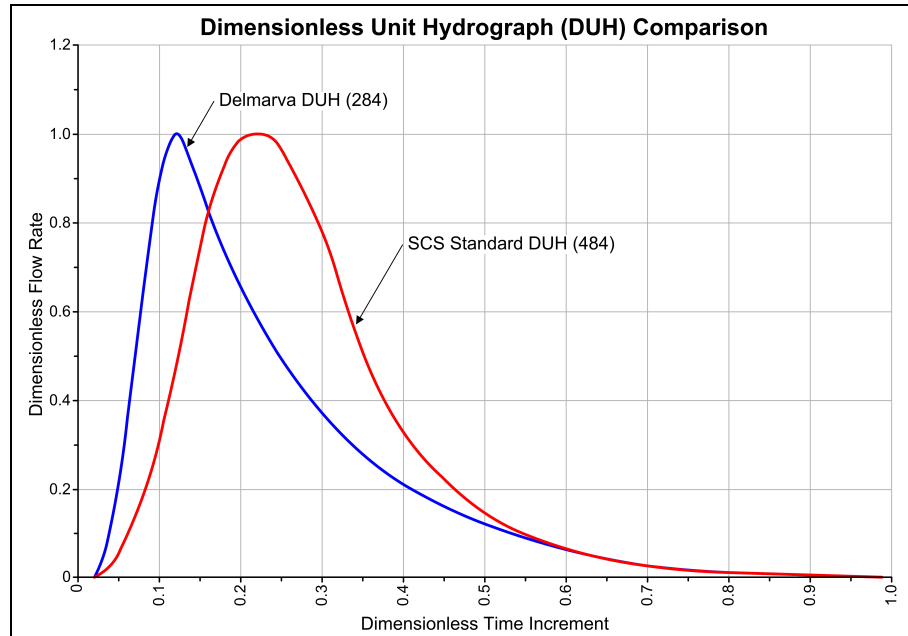

Figure 9.99 Comparison of different dimensionless unit hydrographs

The Dimensionless Unit Hydrographs dialog box, shown in the following figure, is used to specify the peak rate factor that defines the shape of the dimensionless unit hydrographs. These dimensionless unit hydrographs are used in both the SCS TR-20 and SCS TR-55 hydrology computations. The selected peak rate factor and corresponding unit hydrograph is applied to all subbasins.

Select **INPUT ► DIMENSIONLESS UNIT HYDROGRAPH** to display the Dimensionless Unit Hydrographs dialog box. Note that the Dimensionless Unit Hydrographs dialog box is only available if the SCS TR-20 or SCS TR-55 hydrology method is selected from the **HYDROLOGY METHOD** drop-down list in the Project Options dialog box, General tab, described on page 166.

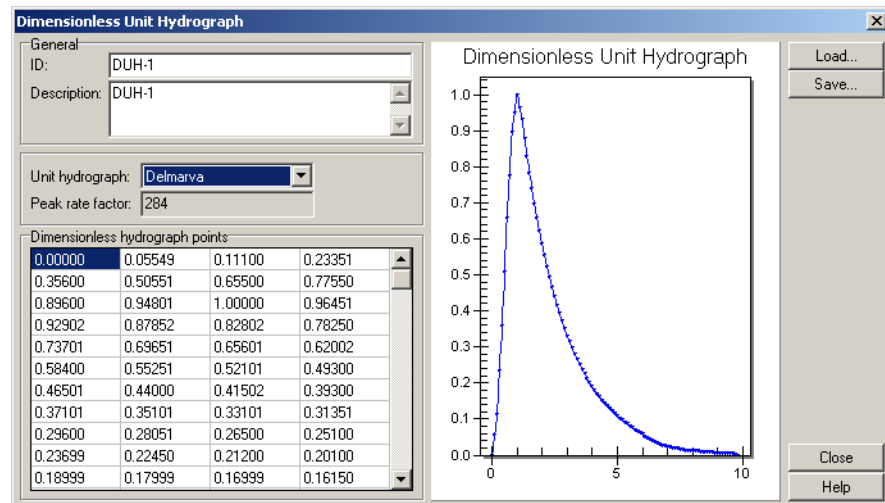

Figure 9.100 The Dimensionless Unit Hydrographs dialog box

The following data are used to define dimensionless unit hydrograph data:

ID

Enter the unique name (or ID) that is to be assigned to the dimensionless unit hydrograph being defined. This name can be alphanumeric (i.e., contain both numbers and letters), can contain spaces, is case insensitive (e.g., *ABC = abc*), and can be up to 128 characters in length. Therefore, the assigned name can be very descriptive, to assist you in identifying different unit hydrographs.

Description (optional)

Enter an optional description that describes the dimensionless unit hydrograph being defined.

Unit Hydrograph

From this drop-down list, select from a list of pre-defined dimensionless unit hydrographs or select **USER-DEFINED** in order to define the peaking factor directly.

Unit Hydrograph	Peaking Factor	Typical Applications
SCS	484	The Soil Conservation Service (SCS) uses this peaking factor nationwide with reasonable success for hydrologic evaluation of small watersheds and for hydrologic design of conservation measures. This is the default dimensionless unit hydrograph used by TR-20 and TR-55.
Delmarva	284	Applies to Atlantic coastal plain watersheds, that are characterized by flat topography (average watershed slope less than 5 percent), low relief, and significant surface storage in swales and depressions.
Georgia-300	300	Georgia Stormwater Management Manual
Georgia-323	323	Georgia Stormwater Management Manual
SWFWMD-256	256	Southwest Florida Water Management District Stormwater Management Manual
User-Defined		Define the peaking factor directly using the PEAK RATE FACTOR entry

Peak Rate Factor

The entry defines the peaking factor, which essentially controls the volume of water on the rising and recession limbs. The default value is 484, which corresponds to the standard SCS unit hydrograph. However, you can enter any value you want and the software will automatically construct the

corresponding dimensionless unit hydrograph and display it as a graphical plot. The following table provides a description of typical hydrograph peaking factors and recession limb ratios (*Wanielista, et al. 1997*).

Peaking Factor	Limb Ratio (Recession to Rising) ^A	Description
575	1.25	Urban areas; steep slope
484	1.67	Standard SCS unit hydrograph
400	2.25	Mixed urban/rural
300	3.33	Rural, rolling hills
200	5.5	Rural, slight slopes
100	12.0	Rural, very flat

^ALimb ratio is the ratio of the recession limb length to the rising limb length

Groundwater Aquifers

Groundwater aquifers are sub-surface groundwater areas used to model the vertical movement of water infiltrating from the subbasins that lie above them. They also permit the infiltration of groundwater into the drainage system, or exfiltration of surface water from the drainage system, depending on the hydraulic gradient that exists. The same groundwater aquifer can be shared by several subbasins.

Groundwater aquifers are only required in models that need to explicitly account for the exchange of groundwater with the drainage system or to establish baseflow and recession curves in natural channels and non-urban systems.

Groundwater aquifers are represented using two zones:

- Un-saturated zone
- Saturated zone

The groundwater aquifer behavior is characterized using parameters such as:

- Soil porosity
- Hydraulic conductivity
- Evapotranspiration depth
- Bottom elevation
- Loss rate to deep groundwater
- Initial water table elevation
- Initial moisture content of the unsaturated zone

Groundwater aquifers are connected to subbasins and to drainage system nodes as defined in a subbasin's groundwater flow data provided in the Groundwater Aquifer Assignment dialog box (see the section titled *Groundwater Aquifer Assignment* on page 428). This data also contains parameters that govern the rate of groundwater flow between the aquifer's saturated zone and the drainage system node.

The software uses a two-zone groundwater aquifer model to represent the interaction of infiltration, evapotranspiration, percolation, and lateral groundwater interflow. An illustration of this two-zone groundwater model is shown in the following figure.

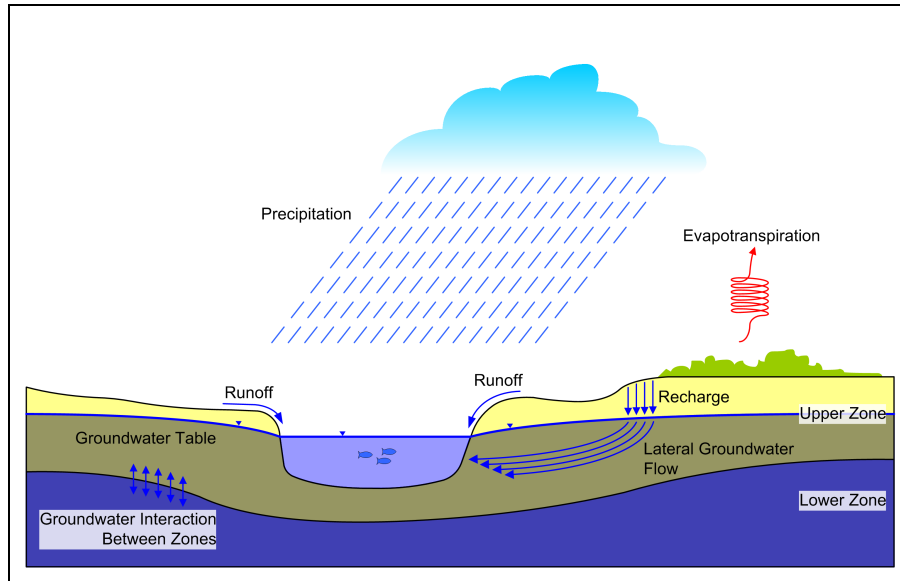

Figure 9.101 The two-zone groundwater model

The upper zone of the aquifer is unsaturated with a variable moisture content. The lower zone is fully saturated and therefore its moisture content is fixed at the soil porosity.

The fluxes shown in Figure 9.101, expressed as volume per unit area per unit time, consist of the following:

- Infiltration from the surface
- Evapotranspiration from the upper zone, which is a fixed fraction of the unused surface evaporation
- Percolation from the upper to lower zone, which depends on the upper zone moisture content and depth
- Evapotranspiration from the lower zone, which is a function of the depth of the upper zone
- Percolation from the lower zone to deep groundwater, which depends on the lower zone depth
- Lateral groundwater interflow to the drainage system, which depends on the lower zone depth as well as the depth in the receiving channel or node

After computing the water fluxes that exist during a given time step, a mass balance is written for the change in water volume stored in each zone so that a new water table depth and unsaturated zone moisture content can be computed for the next time step.

The Groundwater Aquifers dialog box, shown in the following figure, is used to define groundwater aquifers. Select **INPUT** ► **GROUNDWATER AQUIFERS** to display the Groundwater Aquifers dialog box.

ID	Porosity	Conductivity	Water Table Elev.
1	0.5	5.0	1000.0

Figure 9.102 The Groundwater Aquifers dialog box is used to define data for groundwater flow exchange with subbasins

To select a groundwater aquifer, scroll through the displayed table and click the row containing the groundwater aquifer of interest. The provided data entry fields will then display information describing the selected groundwater aquifer. To add a new groundwater aquifer, click the Add button and then enter the appropriate information in the data fields. To delete a groundwater aquifer, select the groundwater aquifer from the table and then click the Delete button.

The following data are used to define a groundwater aquifer:

Aquifer ID

Enter the unique name (or ID) that is to be assigned to the groundwater aquifer being defined. This name can be alphanumeric (i.e., contain both numbers and letters), can contain spaces, is case insensitive (e.g., ABC = abc), and can be up to 128 characters in length. Therefore, the assigned name can be very descriptive, to assist you in identifying different groundwater aquifers.

Porosity

Volume of voids / total soil volume (volumetric fraction) of the aquifer.

Wilting Point

Soil moisture content at which plants cannot survive (volumetric fraction).

Field Capacity

Soil moisture content after all free water has drained off (volumetric fraction).

Hydraulic Conductivity

Soil saturated hydraulic conductivity (in/hr or mm/hr).

Conductivity Log Slope

Average slope of the logarithm of hydraulic conductivity versus moisture deficit (i.e., porosity minus moisture content) curve (in/hr or mm/hr).

Tension Slope

Average slope of soil tension versus soil moisture content curve (inches or mm).

Upper Evaporation Fraction

Fraction of total evaporation available for evapotranspiration in the upper unsaturated zone.

Lower Evaporation Depth

Maximum depth into the lower saturated zone over which evapotranspiration can occur (ft or m).

Lower Groundwater Loss Rate

Rate of percolation from saturated zone to deep groundwater (in/hr or mm/hr).

Bottom Elevation

Elevation of the bottom of the aquifer (ft or m).

Water Table Elevation

Elevation of the water table in the aquifer at the start of the simulation (ft or m).

Unsaturated Zone Moisture

Moisture content of the unsaturated upper zone of the aquifer at the start of the simulation (volumetric fraction). This value cannot exceed the aquifer porosity.

Groundwater Aquifer Assignment

The Groundwater Aquifer Assignment dialog box, as shown in the following figure, is displayed by clicking the  browse button from the **GROUNDWATER AQUIFER** data field in the Subbasins dialog box (see page 348). This dialog box is used to link a subbasin to an aquifer and a node of the drainage system to describe how groundwater is exchanged with an aquifer.

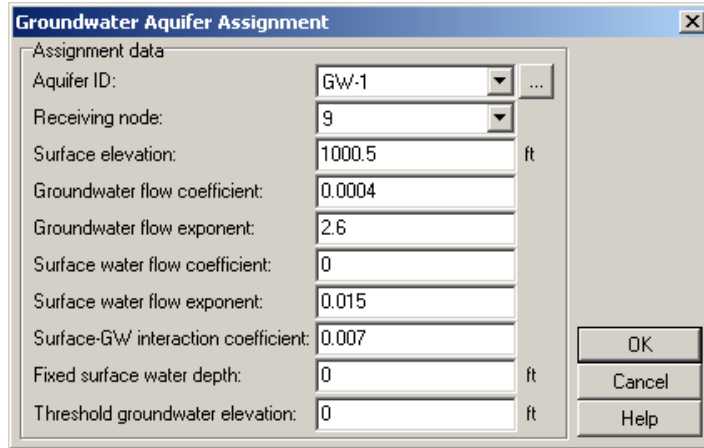

Figure 9.103 The Groundwater Aquifer Assignment dialog box is used to link a subbasin to an aquifer and a node of the drainage system to describe how groundwater is exchanged with the aquifer

Besides assigning the linkage from a subbasin to the aquifer and drainage node, the Groundwater Aquifer Assignment dialog box also specifies coefficients that determine the rate of groundwater flow between the aquifer and the node. These coefficients ($A1$, $A2$, $B1$, $B2$, and $A3$) appear in the following equation that computes groundwater flow as a function of groundwater and surface water heads:

$$Q_{gw} = A1(H_{gw} - E)^{B1} - A2(H_{sw} - E)^{B2} + A3H_{gw}H_{sw}$$

where:

- Q_{gw} = groundwater flow (cfs per acre or cms per hectare)
- H_{gw} = elevation of groundwater table (ft or m)
- H_{sw} = elevation of surface water at receiving node (ft or m)
- E = threshold groundwater elevation or node invert elevation (ft or m)

The below illustration details each of these parameters.

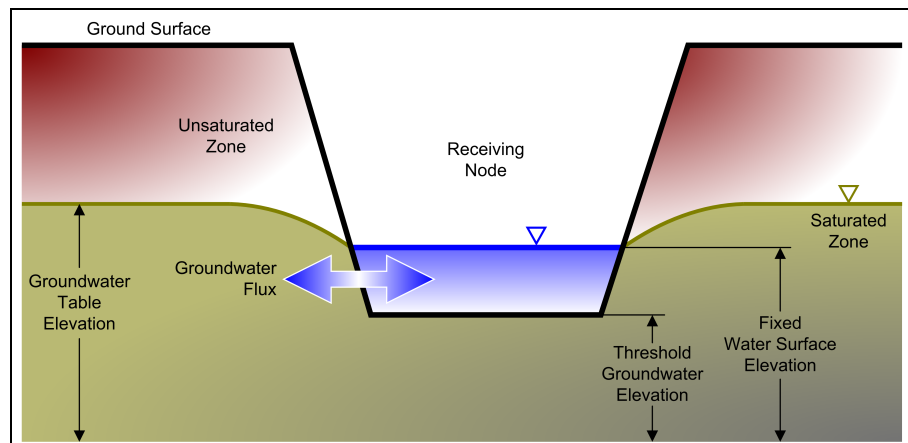

Figure 9.104 Parameters used to compute groundwater flow as a function of groundwater and surface water heads

The following parameters are used to define compute groundwater flow as a function of groundwater and surface water heads:

Aquifer ID

Leave this field blank to indicate that the subbasin does not generate any groundwater flow.

Select from the drop-down list the aquifer that exchanges groundwater with the subbasin being defined. Click the browse button to display the Groundwater Aquifers dialog box, described on page 425, to define a new groundwater aquifer.

Receiving Node

Select from the drop-down list the node that receives groundwater from the aquifer.

Surface Elevation

Elevation of ground surface for the subbasin that lies above the aquifer, in feet or meters.

Groundwater Flow Coefficient

Value of $A1$ in the groundwater flow formula.

Groundwater Flow Exponent

Value of $B1$ in the groundwater flow formula.

Surface Water Flow Coefficient

Value of $A2$ in the groundwater flow formula.

Surface Water Flow Exponent

Value of $B2$ in the groundwater flow formula.

Surface-GW Interaction Coefficient

Value of $A3$ in the groundwater flow formula.

Fixed Surface Water Depth

Fixed depth of surface water at the receiving node (feet or meters), set to zero if surface water depth will vary as computed by flow routing.

Threshold Groundwater Elevation

Elevation which must be reached before any groundwater flow occurs (feet or meters). Leave blank to use the receiving node's invert elevation.

Flow Coefficient Units

The values of the flow coefficients must be in units that are consistent with the groundwater flow units of cfs/acre (for US units) or cms/ha (for SI metric units).

Proportional Groundwater Flow

If groundwater flow is simply proportional to the difference in groundwater and surface water heads, then set the Groundwater and Surface Water Flow Exponents ($B1$ and $B2$) to 1.0, set the Groundwater Flow Coefficient ($A1$) to the proportionality factor, set the Surface Water Flow Coefficient ($A2$) to the same value as $A1$, and set the Interaction Coefficient ($A3$) to zero.

Negative Groundwater Flux

Groundwater flux can be negative, simulating flow from the stream channel into the groundwater aquifer as bank storage. An exception can occur when the Surface Water to Groundwater Interaction Coefficient ($A3$) does not equal 0, since this term is usually derived from groundwater flow models that assume unidirectional flow.

To prevent negative groundwater fluxes (i.e., flow from the channel into the groundwater aquifer), specify the following:

- Groundwater Flow Coefficient ($A1$) greater than or equal to the Surface Water Flow Coefficient ($A2$)
- Groundwater Flow Exponent ($B1$) greater than or equal to the Surface Water Flow Exponent ($B2$)
- Surface Water to Groundwater Interaction Coefficient ($A3$) equal to zero

Snow Packs

The snow melt routine used in the software is a part of the runoff modeling process, and is typically used in continuous or long-term simulations. It updates the state of the snow packs associated with each subbasin by accounting for snow accumulation, snow redistribution by areal depletion and removal operations, and snow melt via heat budget accounting. Any snow melt coming off the pack is treated as an additional rainfall input onto the subbasin.

At each runoff time step, the following computations are made:

- 1 Air temperature and melt coefficients are updated according to the calendar date.
- 2 Any precipitation that falls as snow is added to the snow pack.
- 3 Any excess snow depth on the plowable area of the pack is redistributed according to the removal parameters established for the pack.
- 4 Areal coverages of snow on the impervious and pervious areas of the pack are reduced according to the areal depletion curves defined for the study area.
- 5 The amount of snow in the pack that melts to liquid water is found using:
 - a. A heat budget equation for periods with rainfall, where melt rate increases with increasing air temperature, wind speed, and rainfall intensity.
 - b. A degree-day equation for periods with no rainfall, where melt rate equals the product of a melt coefficient and the difference between the air temperature and the pack's base melt temperature.
- 3 If no melting occurs, the snow pack temperature is adjusted up or down based on the product of the difference between current and past air temperatures and an adjusted melt coefficient. If melting occurs, the temperature of the snow pack is increased by the equivalent heat content of the melted snow, up to the base melt temperature. Any remaining melt liquid beyond this is available to runoff from the snow pack.

- The available snow melt is then reduced by the amount of free water holding capacity remaining in the snow pack. The remaining melt is treated the same as an additional rainfall input onto the subbasin.

The Snow Packs dialog box, shown in the following figure, is used to define snow packs that will be used in the runoff computations. Select **INPUT ► SNOW PACKS** to display the Snow Packs dialog box.

Snow Packs

General

Snow pack ID: SP-01

Description:

Snow pack parameters

Subbasin surface type	Plowable	Impervious	Pervious
Melting coefficients (in/hr/deg F)	0.001	0.001	0.001
Max. melt coeff. (in/hr/deg F)	0.001	0.001	0.001
Base temperature (deg F)	32.0	32.0	32.0
Fraction free water capacity	0.10	0.10	0.10
Initial snow depth (in)	0.00	0.00	0.00
Initial free water (in)	0.00	0.00	0.00
Depth at 100% cover (in)	0.00	0.00	0.00

Fraction of impervious area that is plowable: 0.0

Snow removal parameters

Depth at which snow removal begins: 1.0 in

Fraction transferred out of the watershed: 0.0

Fraction transferred to the impervious area: 0.0

Fraction transferred to the pervious area: 0.0

Fraction converted into immediate melt: 0.0

Fraction moved to another subbasin: 0.0

(Subbasin ID):

Note: Sum of all fractions must be 1.0 or less.

ID	Plowable Fraction	Removable Depth	Description
1 SP-01	0.0	1.0	

Buttons: Add, Delete, Close, Help

Figure 9.105 The Snow Packs dialog box

To select a snow pack, scroll through the displayed table and click the row containing the snow pack of interest. The provided data entry fields will then display information describing the selected snow pack. To add a new snow pack, click the Add button and then enter the appropriate information in the data fields. To delete a snow pack, select the snow pack from the table and then click the Delete button.

The following data are used to define a snow pack:

Snow Pack ID

Enter the unique name (or ID) that is to be assigned to the snow pack being defined. This name can be alphanumeric (i.e., contain both numbers and letters), can contain spaces, is case insensitive (e.g., *ABC = abc*), and can be up to 128 characters in length. Therefore, the assigned name can be very descriptive, to assist you in identifying different snow packs.

Description (optional)

Enter an optional description that describes the snow pack data being defined.

Snow Pack Parameters

The Snow Pack Parameters section is used to specify snow melt parameters and initial conditions for snow that accumulates over three different types of areas:

- Impervious area that is plowable (i.e., subject to snow removal)
- Remaining impervious area
- Pervious area

The following parameters are used to define the snow pack data:

Melting Coefficients

The degree-day snow melt coefficient that occurs on December 21. Units are either in/hr-deg F or mm/hr-deg C.

Maximum Melt Coefficients

The degree-day snow melt coefficient that occurs on June 21. Units are either in/hr-deg F or mm/hr-deg C. For a short term simulation of less than a week, it is acceptable to use a single value for both the minimum and maximum melt coefficients.

The minimum and maximum snow melt coefficients are used to estimate a melt coefficient that varies by day of the year. The latter is used in the following degree-day equation to compute the melt rate for any particular day:

$$\text{Melt Rate} = (\text{Melt Coefficient}) * (\text{Air Temperature} - \text{Base Temperature})$$

Base Temperature

Temperature at which snow begins to melt, in degrees F (for US units) or C (for SI metric units).

Fraction Free Water Capacity

The volume of a snow pack's pore space which must fill with melted snow before liquid runoff from the pack begins, expressed as a fraction of snow pack depth.

Initial Snow Depth

Depth of snow at the start of the simulation (water equivalent depth in inches or mm).

Initial Free Water

Depth of melted water held within the pack at the start of the simulation (water equivalent depth in inches or mm). This number should be at or below the product of the **INITIAL SNOW DEPTH** and the **FRACTION FREE WATER CAPACITY**.

Depth at 100% Cover

The depth of snow beyond which the entire area remains completely covered and is not subject to any areal depletion effect (water equivalent depth in inches or mm).

Fraction of Impervious Area That is Plowable

The fraction of impervious area that is plowable and therefore is not subject to areal depletion.

Snow Removal Parameters

Snow removal practices form a major difference between the snow hydrology of urban and rural areas. Much of the snow cover may be completely removed from heavily urbanized areas, or plowed into windrows or piles, with melt characteristics that differ markedly from those of undisturbed snow. In addition, snow management practices in cities vary according to location, climate, topography, and the storm itself.

The Snow Removal Parameters section describes how snow removal occurs within the plowable area of a snow pack. The following parameters are used to define the snow removal data:

Depth at Which Snow Removal Begins

Depth which must be reached before any snow removal begins (water equivalent depth in inches or mm).

Fraction Transferred Out of the Watershed

The fraction of excess snow depth that is removed from the system (and does not become runoff).

Fraction Transferred to the Impervious Area

The fraction of excess snow depth that is added to snow accumulation on the pack's impervious area.

Fraction Transferred to the Pervious Area

The fraction of excess snow depth that is added to snow accumulation on the pack's pervious area.

Fraction Converted into Immediate Melt

The fraction of excess snow depth that becomes liquid water which runs onto any subbasin associated with the snow pack.

Fraction Moved to Another Subbasin

The fraction of excess snow depth which is added to the snow accumulation on some other subbasin. The Subbasin ID must also be provided.

Note that the various removal fractions must add up to 1.0 or less. If less than 1.0, then some remaining fraction of snow depth will be left on the surface after all of the redistribution options are satisfied.



Snow Depths

All snow depths are treated as “depth of water equivalent” to avoid specification of the specific gravity of the snow pack which is highly variable with time. The specific gravity of new snow is of the order of 0.09; an 11:1 or 10:1 ratio of snow pack depth to water equivalent depth is often used as a rule of thumb. With time,

the pack compresses until the specific gravity can be considerably greater, to 0.5 and above. In urban areas, lingering snow piles may resemble ice more than snow with specific gravities approaching 1.0.

This chapter describes additional data used to define a stormwater or sanitary (wastewater) sewer model.

Climatology

The Climatology dialog box, as shown in the following figure, is used to enter values for various climate-related variables required by certain models, such as those that consider evaporation and snow melt in their simulation. Select **INPUT ► CLIMATOLOGY** to display the Climatology dialog box.

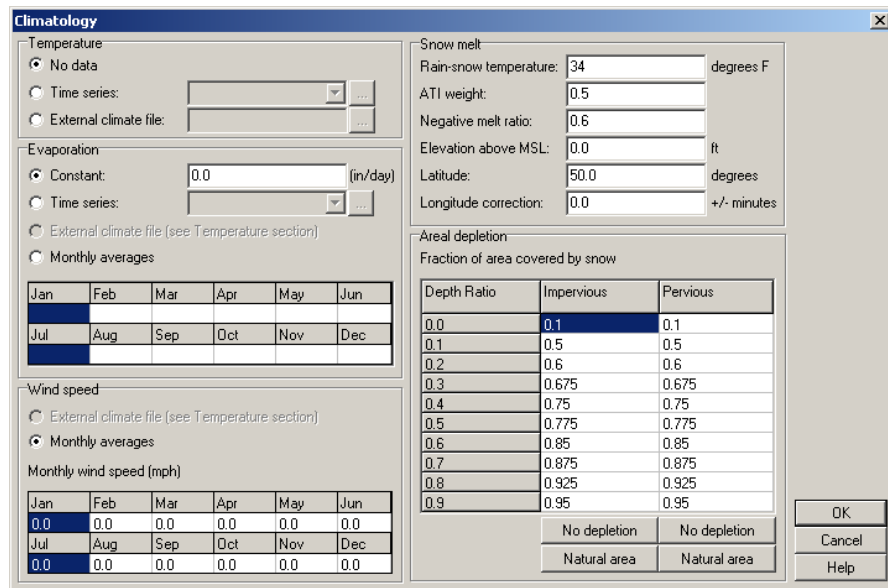

Figure 10.1 The Climatology dialog box

The Climatology dialog box is divided into five sections, where each section defines specific climate data.

Temperature Data

The Temperature section of the Climatology dialog box is used to specify the source of temperature data used for simulating snowfall and snow melt processes during runoff calculations. It can also be used to compute daily evaporation rates. If these processes are not being simulated then temperature data are not required.

Temperature data can be supplied to the software from one of the following sources:

- A user-defined time series of point values (values at intermediate times are interpolated)
- An external climate file containing daily minimum and maximum values (the software fits a sinusoidal curve through these values depending on the day of the year)

For user-defined time series, temperatures are in degrees *F* (for US units) and degrees *C* (for SI metric units). The external climate file can also be used to supply evaporation and wind speed as well.

The following choices are available for defining temperature data:

No Data

Select this choice if snow melt is not being simulated.

Time Series

Select this choice if the variation in temperature over the simulation period will be described by a time series. The drop-down list allows you to select an already defined time series that contains the tabular data of time versus temperature. Click the (...) browse button to display the Time Series dialog box, described on page 467, to define a new time series.

External Climate File

Select this choice if min/max daily temperatures will be read from an external climate file. Specify the name of the file (or click the (...) browse button to select the file).

Evaporation Data

The Evaporation section of the Climatology dialog box is used to specify evaporation rates, in inches/day (or mm/day), for a study area. Evaporation can occur for standing water on subbasin surfaces, for subsurface water in groundwater aquifers, and for water held in detention ponds. Evaporation rates can be stated as:

- A single constant value
- A set of monthly average values
- A user-defined time series of daily values
- Values computed from daily temperatures contained in an external climate file
- Daily values read from an external climate file

If rates are read directly from an external climate file, then a set of monthly pan coefficients should also be supplied to convert the pan evaporation data to free water-surface values.

The following choices are available for defining evaporation rates:

Constant

Use this choice if evaporation remains constant over time. Enter the value in the data field provided. Leave this entry blank if evaporation is not to be considered.

Time Series

Select this choice if evaporation rates will be specified in a time series. The drop-down list allows you to select an already defined time series that contains the tabular data of time versus evaporation rate. Click the browse button to display the Time Series dialog box, described on page 467, to define a new time series. Note that for each date specified in the time series, the evaporation rate remains constant at the value supplied for that date until the next date in the series is reached (i.e., interpolation is not used on the series).

External Climate File

This choice indicates that daily evaporation rates will be read from the same climate file that was specified for temperature. Specify the name of the external file in the Temperature section of this dialog box.

Computed from Temperatures

This choice indicates that daily evaporation rates will be computed using Hargreaves' method from the daily air temperature data contained in the external climate file. This method also uses the site's latitude, which is defined in the Snow Melt section of this dialog box even though snow melt is not being simulated. Specify the name of the external file in the Temperature section of this dialog box.

Monthly Averages

Use this choice to supply an average rate for each month of the year. Enter the value for each month in the data table provided. Note that rates remain constant within each month.

Monthly Soil Recovery Pattern (optional)

From the drop-down list, select an already defined monthly soil recovery time pattern to be used. This entry is optional, and defines a time pattern whose factors adjust the rate at which infiltration capacity is recovered during periods with no precipitation. It applies to all subbasins for any choice of infiltration method.

For example, if the normal infiltration recovery rate was 1% during a specific time period and a pattern factor of 0.8 applied to this period, then the actual recovery rate would be 0.8%. This allows you to account for seasonal soil drying rates. In principle, the variation in pattern factors should mirror the variation in evaporation rates but might be influenced by other factors such as seasonal groundwater levels.

Click the browse button to display the Monthly Soil Recovery Patterns dialog box to define a new time pattern.

Wind Speed Data

The Wind Speed section of the Climatology dialog box is used to specify average monthly wind speeds. The wind speed is an optional climatic variable that is only used when computing snow melt rates under rainfall conditions. Melt rates increase with increasing wind speed. Units of wind speed are miles/hour (for US units) and km/hour (for SI metric units). The software can use either a set of monthly average speeds or wind speed data contained in the same climate file used for daily minimum/maximum temperatures.

The following choices are available for defining wind speeds:

External Climate File

Wind speeds will be read from the same climate file that was specified for temperature. Specify the name of the external file in the Temperature section of this dialog box.

Monthly Averages

Wind speed is specified as an average value that remains constant in each month of the year. Enter a value for each month in the data table provided. The default value is 0.

Snow Melt Data

The Snow Melt section of the Climatology dialog box is used to specify climatic variables that apply across the entire study area when simulating snowfall and snow melt. These parameters include:

- Air temperature at which precipitation falls as snow
- Heat exchange properties of the snow surface
- Study area elevation, latitude, and longitude correction

The following parameters define the snow melt data:

Rain-Snow Temperature

Enter the temperature below at which precipitation falls as snow instead of rain. Use degrees F for (US units) or degrees C (for SI metric units).

ATI (Antecedent Temperature Index) Weight

This parameter reflects the degree to which heat transfer within a snow pack during non-melt periods is affected by prior air temperatures. Smaller values reflect a thicker surface layer of snow which results in reduced rates of heat transfer. Values must be between 0 and 1, with a default value of 0.5.

Negative Melt Ratio

This is the ratio of the heat transfer coefficient of a snow pack during non-melt conditions to the coefficient during melt conditions. Values must be between 0 and 1, with a default value of 0.6.

Elevation above MSL

Enter the average elevation above mean sea level for the study area, in feet or meters. This value is used to provide a more accurate estimate of atmospheric pressure. The default is 0.0, which results in a pressure of 29.9 inches Hg (sea level). The effect of wind on snow melt rates during rainfall periods is greater at higher pressures, which occur at lower elevations.

Latitude

Enter the latitude of the study area in degrees North. This number is used when computing the hours of sunrise and sunset, which in turn are used to extend min/max daily temperatures into continuous values. The default is 50 degrees North.

This entry is also used to compute daily evaporation rates from daily temperature data contained in an external climate file, even though snow melt may not be being simulated.

Longitude Correction

This is a correction, in minutes of time, between true solar time and the standard clock time. It depends on a location's longitude (θ) and the standard meridian of its time zone (SM) through the expression $4(\theta - SM)$. This correction is used to adjust the hours of sunrise and sunset when extending daily min/max temperatures into continuous values. The default value is 0.

Areal Depletion Data

The Areal Depletion section of the Climatology dialog box is used to specify points on the Areal Depletion Curve for both impervious and pervious surfaces within a project's study area.

Areal depletion refers to the tendency of accumulated snow to melt non-uniformly over the surface of a subbasin. As the melting process proceeds, the area covered by snow gets reduced. This behavior is described by an Areal Depletion Curve that plots the fraction of total area that remains snow covered against the ratio of the actual snow depth to the depth at which there is 100% snow cover. A typical Areal Depletion Curve for a natural area is shown in the following figure. Two such curves can be defined in the software, one for impervious areas and another for pervious areas.

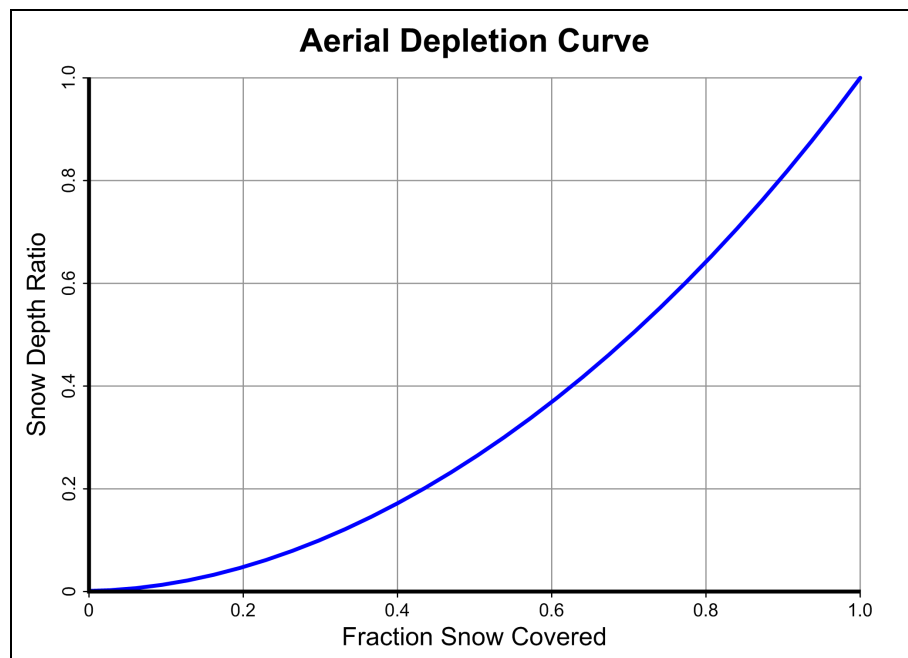

Figure 10.2 Typical Areal Depletion Curve for a natural drainage area

These curves define the relationship between the area that remains snow covered and snow pack depth. Each curve is defined by 10 equal increments of relative depth ratio between 0 and 0.9 (relative depth ratio is the ratio of an area's current snow depth to the depth at which there is 100% areal coverage).

Enter values in the data table provided for the fraction of each area that remains snow covered at each specified relative depth ratio. Valid numbers must be between 0 and 1, and be increasing with increasing depth ratio.

Clicking the Natural Area button fills the table with values that are typical of natural areas. Clicking the No Depletion button will fill the table with all 1's, indicating that no areal depletion occurs. This is the default for new projects.

External Climate File

The software can use an external climate file that contains daily air temperature, evaporation, and wind speed data. The following formats are currently recognized:

- A **DSI-3200** or **DSI-3210** file available from the National Climatic Data Center at:
www.ncdc.noaa.gov/oa/ncdc.html
- Canadian climate files available from Environment Canada at:
www.climate.weatheroffice.ec.gc.ca
- A user-prepared climate file where each line contains a recording station name, the year, month, day, maximum temperature, minimum temperature, and optionally, evaporation rate, and wind speed. If no data are available for any of these items on a given date, then an asterisk should be entered as its value.

An example from a user-prepared climate file is shown below:

```
STA01 2004 6 12 96.2 64.3 00 14.5
STA01 2004 6 12 93.7 65.1 00 9.2
STA01 2004 6 22 89.8 60.2 00 12.4
```

Figure 10.3 Example user-prepared external climate file

When a climate file has days with missing values, the software will use the value from the most recent previous day with a recorded value.

For a user-prepared climate file, the data must be in the same units as the project being analyzed. For US units, temperature is in degrees F, evaporation is in inches/day, and wind speed is in miles/hour. For SI metric units, temperature is in degrees C, evaporation is in mm/day, and wind speed is in km/hour.

Control Rules

The Control Rules dialog box, as shown in the following figure, is used to define operating rules for various model controls defined within the network model. Control rules can be used to simulate the real-time operation of pumps and flow regulators (i.e., inflatable weirs, opening and closing of gates, etc.) in the network system. Select **INPUT** ► **CONTROL RULES** or double-click the **CONTROL RULES**  icon from the data tree to display the Control Rules dialog box.

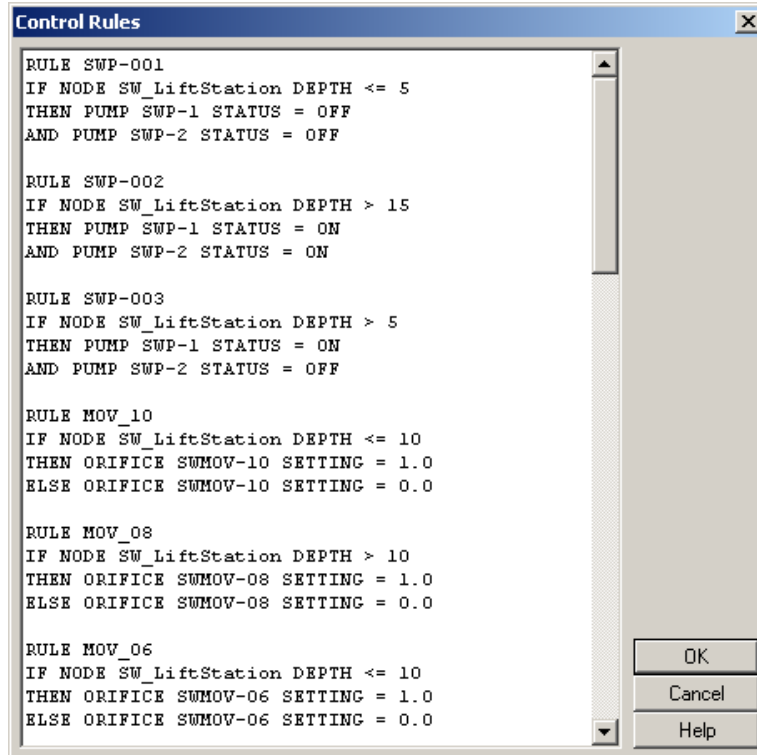

Figure 10.4 The Control Rules dialog box

The Control Rules dialog box is displayed whenever a new control rule is created or an existing rule is selected for editing. The dialog box contains a memo field where the entire set of control rules is displayed and can be edited.

Control Rule Format

Each control rule is a series of statements of the form:

```

RULE ruleID

IF condition_1
AND condition_2
OR condition_3
AND condition_4
(etc.)

THEN action_1
AND action_2
(etc.)

ELSE action_3
AND action_4
(etc.)

PRIORITY value

```

where:

keywords = are shown in BOLDFACE
ruleID = is an ID label assigned to the rule
condition_n = is a Condition Clause
action_n = is an Action Clause
value = is a priority value (e.g., a number from 1 to 5)

The formats used for Condition and Action clauses are discussed below:

- Only the RULE, IF and THEN portions of a rule are required; the ELSE and PRIORITY portions are optional.
- Blank lines between clauses are permitted.
- Any text to the right of a semicolon is considered a comment.
- When mixing AND and OR clauses, the OR operator has higher precedence than AND, i.e.,
IF A or B and C
is equivalent to:
IF (A or B) and C
If the interpretation was meant to be:
IF A or (B and C)
then this can be expressed using two rules as in:
IF A THEN ...
IF B and C THEN ...
- The PRIORITY value is used to determine which rule applies when two or more rules require that conflicting actions be taken on a link. A rule without a priority value always has a lower priority than one with a value. For two rules with the same priority value, the rule that appears first is given the higher priority.

Condition Clauses

A condition clause of a control rule has the following format:

```
element id attribute relation value
```

where:

element = a category of element
id = the element's ID label
attribute = an attribute or property of the element
relation = a relational operator (=, <>, <, <=, >, >=)
value = an attribute value

Some examples of condition clauses are:

```
NODE N23 DEPTH > 10  
PUMP P45 STATUS = OFF  
SIMULATION CLOCKTIME = 22:45:00
```

The elements and attributes that can appear in a condition clause are as follows:

Element	Attributes	Value
Link	FLOW DEPTH	Numeric Value Numeric Value
Node	DEPTH HEAD INFLOW	Numeric Value Numeric Value Numeric Value
Outlet	SETTING	Rating curve multiplier
Orifice	SETTING	Fraction Open
Pump	STATUS SETTING FLOW	ON or OFF Pump curve multiplier Numeric Value
Weir	SETTING	Fraction Open
Simulation	TIME DATE MONTH DAY CLOCKTIME	Elapsed time in decimal hours or hr:min:sec month/day/year month of year (1 - 12) day of week (Sunday = 1) time of day in hr:min:sec

Action Clauses

An action clause of a control rule can have one of the following formats:

```
PUMP      id SETTING = value
PUMP      id STATUS  = ON/OFF
ORIFICE   id SETTING = value
OUTLETS   id SETTING = value
WEIR      id SETTING = value
```

where the meaning of SETTING depends on the element being controlled:

- For Pumps it is a multiplier applied to the flow computed from the pump curve
- For Orifices it is the fractional amount that the orifice is fully open
- For Weirs it is the fractional amount of the original freeboard that exists (i.e., weir control is accomplished by moving the crest height up or down)
- For Outlets it is a multiplier applied to the flow computed from the outlet's rating curve

Some examples of action clauses are:

```
PUMP P67 STATUS = OFF
ORIFICE O212 SETTING = 0.5
```

Modulated Controls

Modulated controls are control rules that provide for a continuous degree of control applied to a pump or flow regulator as determined by the value of some controller variable, such as water depth at a node, or by time. The functional

relation between the control setting and the controller variable can be specified by using:

- Control Curve
- Time Series
- PID (Proportional-Integral-Derivative) Controller

Some examples of modulated control rules are:

```
RULE MC1
IF NODE N2 DEPTH >= 0
THEN WEIR W25 SETTING = CURVE C25

RULE MC2
IF SIMULATION TIME > 0
THEN PUMP P12 SETTING = TIMESERIES TS101

RULE MC3
IF LINK L33 FLOW <> 1.6
THEN ORIFICE O12 SETTING = PID 0.1 0.0 0.0
```

Note how a modified form of the action clause is used to specify the name of the control curve, time series, or PID parameter set that defines the degree of control. A PID parameter set contains three values:

- Proportional gain coefficient
- Integral time (in minutes)
- Derivative time (in minutes)

Also, by convention the controller variable used in a Control Curve or PID Controller will always be the element and attribute named in the previous condition clause of the rule. As an example, in rule MC1, shown above, Curve C25 would define how the fractional setting at Weir W25 varied with the water depth at Node N2. In rule MC3, the PID controller adjusts the opening of Orifice O12 to maintain a flow of 1.6 in Link L33.

PID Controllers

A PID (Proportional-Integral-Derivative) Controller is a generic closed-loop control scheme that tries to maintain a desired set-point on some process variable by computing and applying a corrective action that adjusts the process accordingly. PID controllers are used in RTC (Real Time Control) network systems, as are commonly used in wastewater flow management.

In the context of a hydraulic conveyance system, a PID controller might be used to adjust the opening on a gated orifice to maintain a target flow rate in a specific conduit or to adjust a variable speed pump to maintain a desired depth in a storage unit.

The classical PID controller equation has the form:

$$m(t) = K_p \left[e(t) + \frac{1}{T_i} \int e(\tau) d\tau + T_d \frac{de(t)}{dt} \right]$$

where:

$m(t)$ = controller output
 K_p = proportional coefficient (gain)
 T_i = integral time
 T_d = derivative time
 $e(t)$ = error (difference between setpoint and observed variable value)
 t = time

The performance of a PID controller is determined by the values assigned to the coefficients K_p , T_i , and T_d .

The controller output $m(t)$ has the same meaning as a link setting used in a rule's Action Clause while dt is the current flow routing time step in minutes. Because link settings are relative values (with respect to either a pump's standard operating curve or to the full opening height of an orifice or weir) the error $e(t)$ used by the controller is also a relative value. It is defined as the difference between the control variable setpoint x^* and its value at time t , $x(t)$, normalized to the setpoint value: $e(t) = (x^* - x(t)) / x^*$.

Note that for direct action control, where an increase in the link setting causes an increase in the controlled variable, the sign of K_p must be positive. For reverse action control, where the controlled variable decreases as the link setting increases, the sign of K_p must be negative. You must recognize whether the control is direct or reverse action and use the proper sign on K_p accordingly. For example, adjusting an orifice opening to maintain a desired downstream flow is direct action. Adjusting it to maintain a downstream water level is reverse action while adjusting it to maintain an upstream water level is direct action. Controlling a pump to maintain a fixed wet well water level would be reverse action while using it to maintain a fixed downstream flow is direct action.

Conditional Rule Examples

Examples of various control rules are shown below.

```
RULE R1
IF SIMULATION TIME > 8
THEN PUMP 12 STATUS = ON
ELSE PUMP 12 STATUS = OFF
```

Figure 10.5 Simple time-based pump control

```

RULE R2A
IF NODE 23 DEPTH > 12
AND LINK 165 FLOW > 100
THEN ORIFICE R55 SETTING = 0.5

RULE R2B
IF NODE 23 DEPTH > 12
AND LINK 165 FLOW > 200
THEN ORIFICE R55 SETTING = 1.0

RULE R2C
IF NODE 23 DEPTH <= 12
OR LINK 165 FLOW <= 100
THEN ORIFICE R55 SETTING = 0

```

Figure 10.6 Multiple condition orifice gate control

```

RULE R3A
IF NODE N1 DEPTH > 5
THEN PUMP N1A STATUS = ON

RULE R3B
IF NODE N1 DEPTH > 7
THEN PUMP N1B STATUS = ON

RULE R3C
IF NODE N1 DEPTH <= 3
THEN PUMP N1A STATUS = OFF
AND PUMP N1B STATUS = OFF

```

Figure 10.7 Pump station operation control

```

RULE R4
IF NODE N2 DEPTH >= 0
THEN WEIR W25 SETTING = CURVE C25

```

Figure 10.8 Modulated weir height control

```

RULE R05A
IF NODE N09 DEPTH > 1.5
THEN ORIFICE 002 SETTING = 1.0
ELSE ORIFICE 002 SETTING = 0.0

RULE R05B
IF NODE N09 DEPTH <= 1.5
THEN ORIFICE 001 SETTING = 1.0
ELSE ORIFICE 001 SETTING = 0.0

```

Figure 10.9 Orifice control rule

```

RULE R6
IF LINK L3 FLOW <=>= 1.6
THEN ORIFICE 012 SETTING = PID 0.1 0.0 0.0

```

Figure 10.10 PID (Proportional-Integral-Derivative) Controller control rule

Control Settings

The Control Settings dialog box, as shown in the following figure, is displayed when a new user-defined control settings curve is created or an existing user-defined control settings curve is selected for editing. This dialog box specifies how the control setting of a pump or flow regulator varies as a function of some control variable (such as water level at a particular node) as specified in a modulated control rule.

Select **INPUT ► CONTROL SETTINGS** or double-click the **CONTROL SETTINGS**  icon from the data tree to display the Control Settings dialog box.

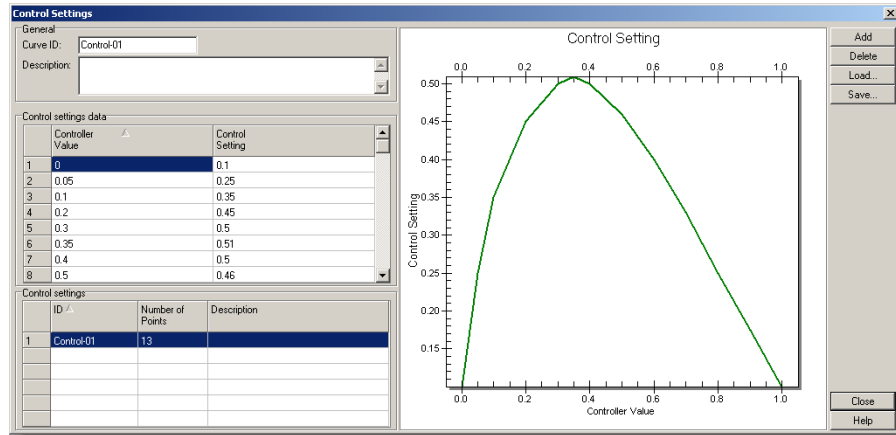

Figure 10.11 The Control Settings dialog box

To select a control setting, scroll through the displayed table of defined control settings and click the row containing the control setting of interest. The data entry fields will then display the information describing the selected control setting. To add a new control setting, click the Add button and then enter the appropriate information in the data fields. To delete a control setting, select the control setting from the table and then click the Delete button.

The following values are used to define the control setting:

Control Setting ID

Enter the unique name (or ID) that is to be assigned to the control setting being defined. This name can be alphanumeric (i.e., contain both numbers and letters), can contain spaces, is case insensitive (e.g., *ABC = abc*), and can be up to 128 characters in length. Therefore, the assigned name can be very descriptive, to assist you in identifying different control settings.

Description (optional)

Enter an optional description that describes the control setting being defined.

Controller Value / Control Setting

This table is used to define the controller values and corresponding control settings.

By convention, the Controller Value used in a control setting curve will always be the element and attribute named in the last condition clause of the rule. As an example, for the following control rule MC1, the **CONTROLLER VALUE** is the water depth at Node N2 and **CONTROL SETTINGS** is the fractional setting at Weir W25.

```

RULE MC1
IF NODE N2 DEPTH >= 0
THEN WEIR W25 SETTING = CURVE C25
    
```

Right-Click Context Menu

Right-click the data table to display a context menu. This menu contains commands to cut, copy, insert, and paste selected cells in the table as well as

options to insert or delete rows. The table values can be highlighted and copied to the clipboard for pasting into Microsoft Excel. Similarly, Excel data can be pasted into the table.

Importing and Exporting Control Setting Data

Click the Load button to import control setting data that was previously saved to an external file or click the Save button to export the current control setting data to an external file.

Pollutants

The software can simulate the generation, inflow, and transport of any number of user-defined pollutants. Required information for each pollutant include:

- Pollutant name
- Concentration units (i.e., milligrams/liter, micrograms/liter, or counts/liter)
- Concentration in rainfall
- Concentration in groundwater
- Concentration in direct infiltration/inflow
- First-order decay coefficient

Co-pollutants can also be defined. For example, the pollutant TSS can have a co-pollutant NaCl (sodium chloride or road salt), meaning that the runoff concentration of TSS will have some fixed fraction of the runoff concentration of NaCl added to it.

Pollutant buildup and washoff from subbasin areas are determined by the land types assigned to those areas. Input loadings of pollutants to the drainage system can also originate from external time series inflows as well as from dry weather inflows.

The Pollutants dialog box, as shown in the following figure, is displayed when a new pollutant is created or an existing pollutant is selected for editing. Select **INPUT ► POLLUTANTS** or double-click the **POLLUTANTS**  icon from the data tree to display the Pollutants dialog box.

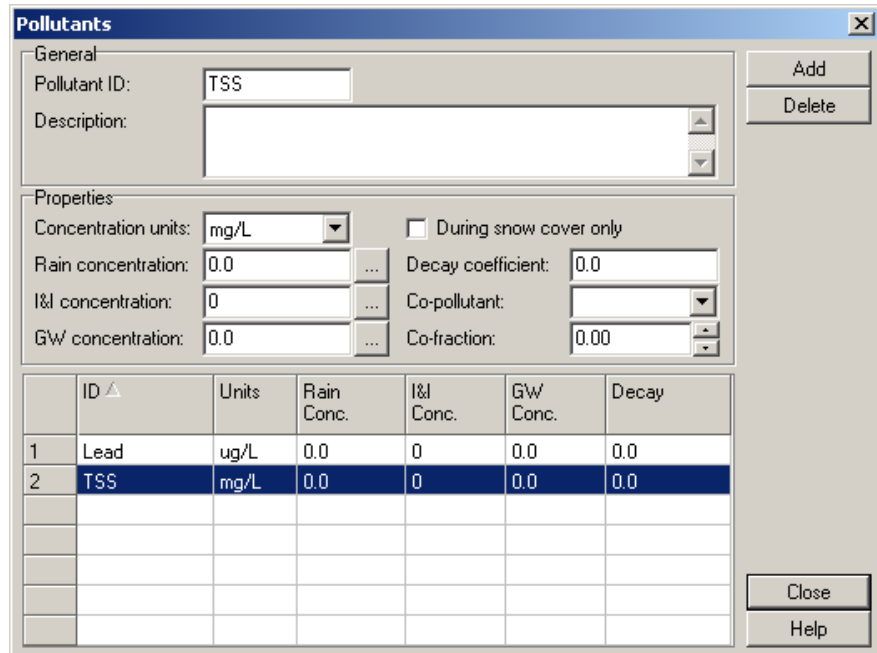

Figure 10.12 The Pollutants dialog box

To select a pollutant, scroll through the displayed table and click the row containing the pollutant of interest. The provided data entry fields will then display information describing the selected pollutant. To add a new pollutant, click the Add button and then enter the appropriate information in the data fields. To delete a pollutant, select the pollutant from the table and then click the Delete button.

The following data are used to define a pollutant:

Pollutant ID

Enter the unique name (or ID) that is to be assigned to the pollutant being defined. This name can be alphanumeric (i.e., contain both numbers and letters), can contain spaces, is case insensitive (e.g., ABC = abc), and can be up to 128 characters in length. Therefore, the assigned name can be very descriptive, to assist you in identifying different pollutants.

Concentration Units

Select the appropriate concentration units from the drop-down list in which the pollutant concentration is being input as. Available concentration units are:

- mg/L
- ug/L
- #/L (counts/L)

Rain Concentration

Concentration of the pollutant in rain water (expressed in concentration units). Clicking the (...) browse button will display the Water Quality reference dialog box, as shown in the following figure, which lists typical water quality pollutant values for urban runoff.

Water Quality Characteristics for Urban Runoff		
Constituent	Event Mean Concentrations	Units
TSS	180 - 548	(mg/L)
BOD	12 - 19	(mg/L)
COD	82 - 178	(mg/L)
Total P	0.42 - 0.88	(mg/L)
Soluble P	0.15 - 0.28	(mg/L)
TKN	1.90 - 4.18	(mg/L)
NO2/NO3-N	0.86 - 2.20	(mg/L)
Total Cu	43 - 118	(ug/L)
Total Pb	182 - 443	(ug/L)
Total Zn	202 - 633	(ug/L)

Source: U.S. Environmental Protection Agency, 1983. Results of the Nationwide Urban Runoff Program (NURP), Vol. 1, NTIS PB 84-185552, Water Planning Division, Washington, DC.

Figure 10.13 The Water Quality reference dialog box provides typical water quality pollutant values for urban runoff

I & I Concentration

Concentration of the pollutant for any infiltration and/or inflow (expressed in concentration units). Clicking the (...) browse button will display the Water Quality reference dialog box, as shown in the above figure, which lists typical water quality pollutant values for urban runoff.

Groundwater Concentration

Concentration of the pollutant in groundwater (expressed in concentration units). Clicking the (...) browse button will display the Water Quality reference dialog box, as shown in the above figure, which lists typical water quality pollutant values for urban runoff.

During Snow Cover Only

This check box should be selected if the pollutant buildup occurs only when there is snow cover. This check box is commonly used for defining roadway and highway deicers. Among the various contaminants found in deposited snow and melt water, chlorides and lead appear to be the most serious and potentially hazardous. By default this check box is not selected.

Decay Coefficient

First-order decay coefficient (in 1/days).

Co-Pollutant

Select from the drop-down list another previously defined pollutant whose runoff concentration contributes to the runoff concentration of the current pollutant.

Co-Fraction

Specify the decimal percentage (i.e., 45% = 0.45) fraction for the previously defined co-pollutant that contributes to the runoff concentration of the current pollutant.

Co-Pollutant Example

An example of a co-pollutant relationship would be where the runoff concentration of a particular heavy metal is some fixed fraction of the runoff concentration of suspended solids. In this case suspended solids would be declared as the co-pollutant for the heavy metal.

Pollutants Land Types

Land type data (or sometimes called land use) is broken up into categories of development activities or land surface characteristics assigned to subbasins. Examples of land types are residential, commercial, industrial, and undeveloped. Land surface characteristics might include rooftops, lawns, paved roads, undisturbed soils, etc. Land types are used solely to account for spatial variation in pollutant buildup and washoff rates within subbasins.

The software has many options for defining land types and assigning them to subbasin areas. One approach is to assign a mix of land types for each subbasin, which results in all land types within the subbasin having the same pervious and impervious characteristics. Another approach is to create subbasins that have a single land type classification along with a distinct set of pervious and impervious characteristics that reflects the classification.

The following processes can be defined for each land type:

- Street cleaning
- Pollutant buildup (defines rate at which pollutant buildup occurs between storm events)
- Pollutant washoff (defines rate at which pollutant washoff occurs during a storm event)

The Pollutants Land Types dialog box, as shown in the following figure, is used to define a category of activity for the study area and to define its street sweeping, pollutant buildup, and pollutant washoff characteristics. Select **INPUT ► POLLUTANT LAND TYPES** or double-click the **POLLUTANTS LAND TYPES**  icon from the data tree to display the Pollutants Land Types dialog box.

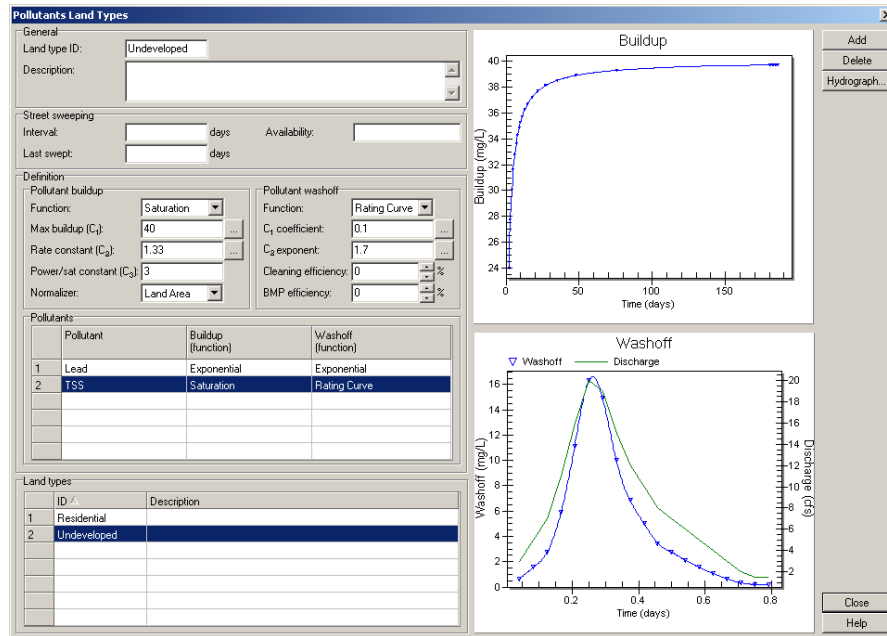

Figure 10.14 The Pollutants Land Types dialog box

To select a pollutant land type, scroll through the displayed table of land types and click the row containing the land type of interest. The provided data entry fields will then display information describing the selected pollutant land type. To add a new pollutant land type, click the Add button and then enter the appropriate information in the data fields. To delete a pollutant land type, select the pollutant land type from the table of land types and then click the Delete button.

The following sections are used to define the pollutant land type data.

General

As shown in Figure 10.14, the General section of the Pollutants Land Types dialog box is used to specify the following general parameters of a land type.

Land Type ID

Enter the unique name (or ID) that is to be assigned to the land type being defined. This name can be alphanumeric (i.e., contain both numbers and letters), can contain spaces, is case insensitive (e.g., $ABC = abc$), and can be up to 128 characters in length. Therefore, the assigned name can be very descriptive, to assist you in identifying different land types.

Description (optional)

Enter an optional description that describes the land type being defined.

Street Sweeping

Street sweeping can be used on each land type to periodically reduce the accumulated buildup of specific pollutants.

The parameters that describe street sweeping include:

- Days between sweeping
- Days since the last sweeping at the start of the simulation
- The fraction of buildup of all pollutants that is available for removal by sweeping
- The fraction of available buildup for each pollutant removed by sweeping

Note that these parameters can be different for each land type, and the last parameter can vary also with each pollutant constituent.

Street Sweeping Interval (days)

Specify the number of days between street sweeping for the land type being defined.

Street Sweeping Availability

Specify the decimal fraction of buildup of all pollutants that is available for removal by sweeping.

Last Swept (days)

Specify the number of days since the last street sweeping for the start of the simulation.

Pollutant Buildup

The Pollutant Buildup section is used to specify the properties of pollutant buildup over the land type during dry weather periods (i.e., between storm events). Select the constituent from the pollutants table whose buildup properties are to be defined.

Pollutant buildup that accumulates within a land type is described (or “normalized”) by either a mass per unit of subbasin area or per unit of curb length. Mass is expressed in pounds (for US units) and kilograms (for SI metric units).

The amount of buildup is a function of the number of preceding dry weather days (prior to the storm event) and can be computed using one of the following functions.

Power Function

Pollutant buildup accumulates proportionally to time, until a maximum limit is achieved:

$$B = \text{Min}(C_1, C_2 t^{C_3})$$

where:

- B = pollutant buildup
- C_1 = maximum buildup possible (mass per unit of area or curb length)
- C_2 = buildup rate constant
- C_3 = time exponent
- t = time (days)

Exponential Function

Pollutant buildup follows an exponential growth curve that approaches a maximum limit asymptotically:

$$B = C_1(1 - e^{-C_2t})$$

where:

- B = pollutant buildup
- C_1 = maximum buildup possible (mass per unit of area or curb length)
- C_2 = buildup rate constant (1/days)
- t = time (days)

Saturation Function

Pollutant buildup begins at a linear rate that continuously declines with time until a saturation value is reached:

$$B = \frac{C_1t}{C_2 + t}$$

where:

- B = pollutant buildup
- C_1 = maximum buildup possible (mass per unit of area or curb length)
- C_2 = half-saturation constant (days to reach half of the maximum buildup)
- t = time (days)

The following data are used to define pollutant buildup:

Function

From the drop-down list, select the buildup function to use for the pollutant. The following buildup functions are available:

- None** No pollutant buildup occurs
- Power** Pollutant buildup accumulates proportionally to time, until a maximum limit is achieved
- Exponential** Pollutant buildup follows an exponential growth curve that approaches a maximum limit asymptotically
- Saturation** Pollutant buildup begins at a linear rate that continuously declines with time until a saturation value is reached

Maximum Buildup (C_1)

The maximum buildup that can occur, expressed as lbs (or kg) of the pollutant per unit of the normalizer variable (see below). This is the same as the C_1 coefficient used in the buildup formulas discussed above.

Clicking the browse button will display the Buildup Parameters reference dialog box, as shown in the following figure, which lists typical buildup values for various land uses and pollutants.

Buildup Parameters	Landuse Categories							
	Low-Density Residential		High-Density Residential		Industrial		Undeveloped	
	C ₁	C ₂	C ₁	C ₂	C ₁	C ₂	C ₁	C ₂
Total Suspended Solids (TSS)	20.00	0.660	50.00	2.060	130.00	6.150	40.00	1.330
BOD ₅	1.00	3.470e-3	1.50	6.940e-3	2.50	0.018	1.10	0.004
Total Nitrogen (TN)	1.40	0.300e-3	1.20	1.130e-3	2.00	2.640e-3	1.50	0.450e-3
Total Phosphorous (TP)	0.50	0.030e-3	0.70	0.120e-3	1.00	0.160e-3	0.40	0.020e-3
Copper (Cu)	1.90	0.600e-3	1.20	0.150e-3	3.00	0.540e-3	2.20	0.530e-3
Lead (Pb)	10.00	0.014	21.00	0.038	50.00	0.140	8.00	0.013
Petroleum, Oil and Grease*	1.40	0.590e-3	3.20	3.910e-3	9.20	0.025	1.20	0.270e-3

*Buildup coefficients are assumed values due to limited literature data.
Source: Manning et al. 1977.

Figure 10.15 The Buildup Parameters reference dialog box provides typical buildup values for various land uses and pollutants

Rate Constant (C₂)

The time constant that governs the rate of pollutant buildup. This is the C₂ coefficient used in the buildup formulas discussed above. For Power buildup its units are mass/days raised to a power, while for Exponential buildup its units are 1/days.

Clicking the [...] browse button will display the Buildup Parameters reference dialog box, as shown in the above figure, which lists typical buildup parameters for various land uses and pollutants.

Power Exponent / Saturation Constant (C₃)

This is the C₃ exponent used in the Power buildup formula, or the half-saturation C₂ constant used in the Saturation buildup formula discussed above. For the latter case, its units are days.

Normalizer

This drop-down list defines which variable in which buildup is normalized on a per unit basis. The drop-down list choices are either **LAND AREA** (in acres or hectares) or **CURB LENGTH**. Any unit of measure can be used for curb length, as long as they remain the same for all subbasins in the project.

Pollutant Washoff

The Pollutant Washoff section is used to specify the properties of pollutant washoff over the land type during a storm event. Select the constituent from the pollutants table whose washoff properties are to be defined.

Pollutant washoff from a given land type occurs during wet weather periods and can be described in one of the following methods. Note that buildup is continuously depleted as washoff proceeds, and washoff ceases when there is no more buildup available.

Washoff loads for a given pollutant and land type can be reduced by a fixed percentage by specifying a Best Management Practice (BMP) removal efficiency that reflects the effectiveness of any BMP controls associated with the land type. It is also possible to use the Event Mean Concentration option (see below) by itself, without having to model any pollutant buildup at all.

The following pollutant washoff functions can be simulated:

Exponential Function

The washoff load in units of mass per hour is proportional to the product of runoff raised to some power and to the amount of buildup remaining:

$$W = C_1 q^{C_2} B$$

where:

- W = washoff load
- C_1 = washoff coefficient
- C_2 = washoff exponent
- q = runoff rate per unit area (inches/hour or mm/hour)
- B = pollutant buildup total mass (lbs or kg), not per unit area or curb length

Washoff mass units are the same as the units used to express the pollutant's concentration (i.e., milligrams, micrograms, or counts).

Rating Curve Function

The rate of washoff in mass per second is proportional to the runoff rate raised to some power:

$$W = C_1 Q^{C_2}$$

where:

- W = washoff load
- C_1 = washoff coefficient
- C_2 = washoff exponent
- Q = runoff rate in user-defined flow units

Event Mean Concentration Function

This is a special case of Rating Curve Washoff function where the exponent is 1.0 and the coefficient C_1 represents the washoff pollutant concentration in mass per liter. Note that the conversion between user-defined flow units used for runoff and liters is handled internally by the software.

$$W = C_1 Q$$

where:

- W = washoff load
- C_1 = washoff coefficient
- Q = runoff rate in user-defined flow units

The following data are used to define pollutant washoff:

Function

From the drop-down list, select the washoff function to use for the pollutant. The following washoff functions are available:

- None** No pollutant washoff occurs
- Exponential** Pollutant washoff is proportional to the runoff and the amount of buildup remaining
- Rating Curve** Pollutant washoff is proportional to the runoff
- Event Mean** Pollutant washoff is proportional to the runoff based upon an event mean concentration

C₁ Coefficient

This is the C₁ coefficient used in the exponential and rating curve washoff formulas, and the event mean concentration formula discussed above.

Clicking the (...) browse button will display the Washoff Parameters reference dialog box, as shown in the following figure, which lists typical washoff values for various land uses and pollutants.

Washoff Parameters	Landuse Categories							
	Low-Density Residential		High-Density Residential		Industrial		Undeveloped	
	C ₁	C ₂	C ₁	C ₂	C ₁	C ₂	C ₁	C ₂
Total Suspended Solids (TSS)	0.40	2.00	0.70	2.20	0.30	2.50	0.10	1.70
BOD ₅	0.02	0.20	0.09	0.40	0.10	0.70	0.01	0.05
Total Nitrogen (TN)	0.10	0.70	0.30	0.40	0.20	0.80	0.02	0.30
Total Phosphorous (TP)	0.40	0.02	0.90	0.09	0.60	0.10	0.20	0.04
Copper (Cu)	0.20	1.50	0.50	1.60	0.90	1.80	0.30	1.50
Lead (Pb)	0.02	1.80	0.30	1.80	0.40	2.00	0.09	1.50
Petroleum, Oil and Grease	0.40	0.50	0.20	0.70	0.10	0.90	0.02	0.40

Source: Huber and Dickinson, 1992.

Figure 10.16 The Washoff Parameters reference dialog box provides typical washoff values for various land uses and pollutants

C₂ Exponent

This is the C₂ exponent used in the exponential and rating curve washoff formulas discussed above.

Clicking the (...) browse button will display the Washoff Parameters reference dialog box, as shown in the above figure, which lists typical washoff values for various land uses and pollutants.

Cleaning Efficiency

The street cleaning removal efficiency (percent) for the pollutant. It represents the fraction of the amount that is available for removal on the land type as a whole (defined in the Street Sweeping section of this dialog box) which is actually removed.

BMP Efficiency

Removal efficiency (percent) associated with any Best Management Practice (BMP) that might have been implemented. The pollutant load computed at each time step (after the washoff computation) is simply reduced by this amount.



Pollutant Washoff Function Plots

Note that the software will plot the selected pollutant buildup and washoff functions in the Pollutants Land Types dialog box as shown above in Figure 10.14 on page 454. However, note that the washoff functions are dependent upon the actual computed runoff hydrograph, and therefore change based upon the simulation results. By default, the software includes an assumed runoff hydrograph for computing a graphical plot of the washoff function. This default runoff hydrograph can be accessed by clicking the Hydrograph button. The Hydrograph dialog box is then displayed, as shown in the following figure

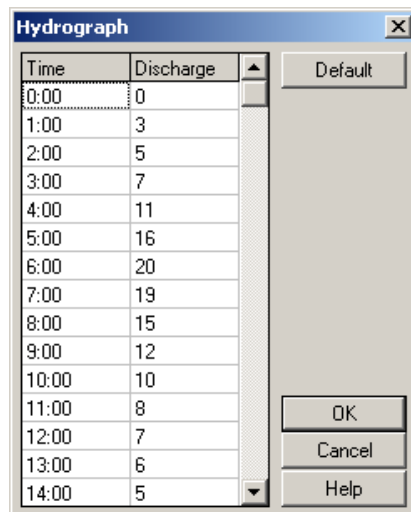

Figure 10.17 The Hydrograph dialog box allows you to change the default hydrograph to be used in determining the washoff graphical plot

You can change the time series values used to define the default hydrograph. Clicking the Default button will reset the hydrograph back to the default values.

Pollutants

The Pollutants table provides a list of already defined pollutant constituents. The pollutants constituents are defined in the Pollutants dialog box, as described in section titled *Pollutants* on page 450. Select each pollutant constituent in the table and define the corresponding buildup and washoff properties for the current land type.

Pollutant Land Type Assignment

The Pollutant Land Type Assignment dialog box, as shown in the following figure, is displayed by clicking the (...) browse button from the **LAND TYPES** data field in the Subbasins dialog box (see page 348).

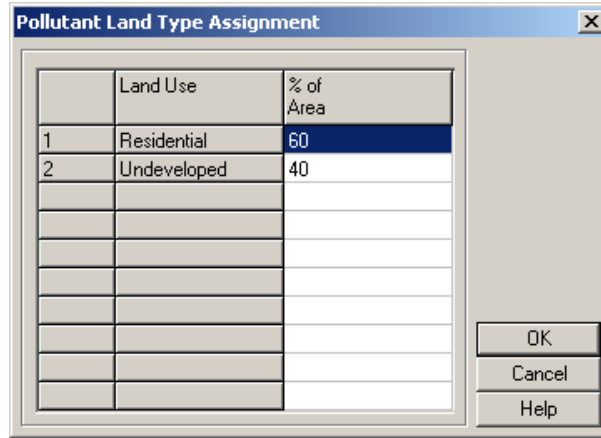

Figure 10.18 The Pollutant Land Type Assignment dialog box

The Pollutant Land Type Assignment dialog box assigns land uses to the subbasin for water quality simulations. The percentage of land area in the subbasin covered by each land use is entered next to its respective land use category. If a listed land use is not present within the current subbasin, its field can be left blank. The percentages entered do not necessarily have to add up to 100%, but cannot total more than 100%. The software will automatically normalize the percentages to 100% when performing its computations.

To define additional land types, see the section titled *Pollutants Land Types* on page 453.

In addition to pollutants from surface runoff, the External Inflows for Node dialog box allows pollutants to be introduced into the network nodes through user-defined time series of direct inflows, dry weather inflows, and RDII (rainfall dependent infiltrations/inflows). See the section titled *External Inflows for Node* on page 408 for more information.

Initial Pollutants

The Initial Pollutants dialog box, as shown in the following figure, is displayed by clicking the (...) browse button from the INITIAL POLLUTANTS data field in the Subbasins dialog box (see page 348).

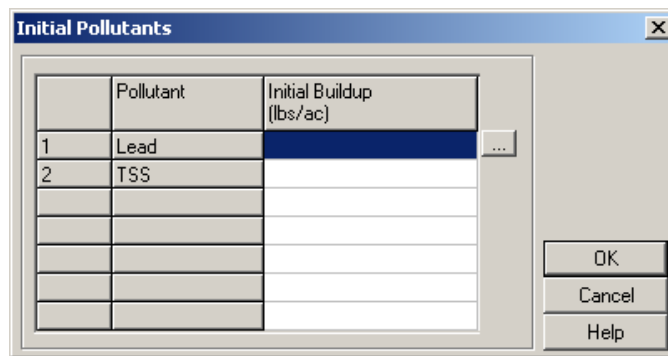

Figure 10.19 The Initial Pollutants dialog box

The Initial Pollutants dialog box is used to define the amount of initial pollutants (sometimes called buildup) that exist over the subbasin at the start of the

simulation. The dialog box consists of a data entry grid with two columns. The first column lists the name of each pollutant in the project and the second column contains edit boxes for entering the initial buildup values. If no buildup value is supplied for a pollutant, it is assumed to be 0.

Clicking the browse button will display the Water Quality reference dialog box, as shown in the following figure, which lists typical initial water quality values for urban runoff for standard water quality constituents.

The figure shows a dialog box titled "Water Quality" with a sub-header "Water Quality Characteristics for Urban Runoff". It contains a table with three columns: "Constituent", "Event Mean Concentrations", and "Units". The table lists various pollutants and their typical concentration ranges and units. At the bottom of the dialog box, there is a source citation: "Source: U.S. Environmental Protection Agency, 1983. Results of the Nationwide Urban Runoff Program (NURP), Vol. 1, NTIS PB 84-185552, Water Planning Division, Washington, DC."

Constituent	Event Mean Concentrations	Units
TSS	180 - 548	(mg/L)
BOD	12 - 19	(mg/L)
COD	82 - 178	(mg/L)
Total P	0.42 - 0.88	(mg/L)
Soluble P	0.15 - 0.28	(mg/L)
TKN	1.90 - 4.18	(mg/L)
NO2/NO3-N	0.86 - 2.20	(mg/L)
Total Cu	43 - 118	(ug/L)
Total Pb	182 - 443	(ug/L)
Total Zn	202 - 633	(ug/L)

Source: U.S. Environmental Protection Agency, 1983. Results of the Nationwide Urban Runoff Program (NURP), Vol. 1, NTIS PB 84-185552, Water Planning Division, Washington, DC.

Figure 10.20 The Water Quality reference dialog box provides typical water quality values for urban runoff for standard water quality constituents

To define additional pollutants, see the Pollutants dialog box described on page 450.

Units

When US units are being used, the units for buildup are pounds per acre. When SI metric units are being used, the units are kilograms per hectare.

Computed Initial Buildup

If a non-zero value is specified for the initial buildup of a pollutant, it will override any initial buildup computed from the **ANTECEDENT DRY DAYS** parameter specified on the Dates section of the Analysis Options dialog box described on page 72.

Pollutant Treatments

The Pollutant Treatments dialog box, as shown in the following figure, is displayed by clicking the browse button from the **TREATMENTS** data field in the Junctions, Outfalls, Flow Diversions, and Storage Nodes dialog boxes.

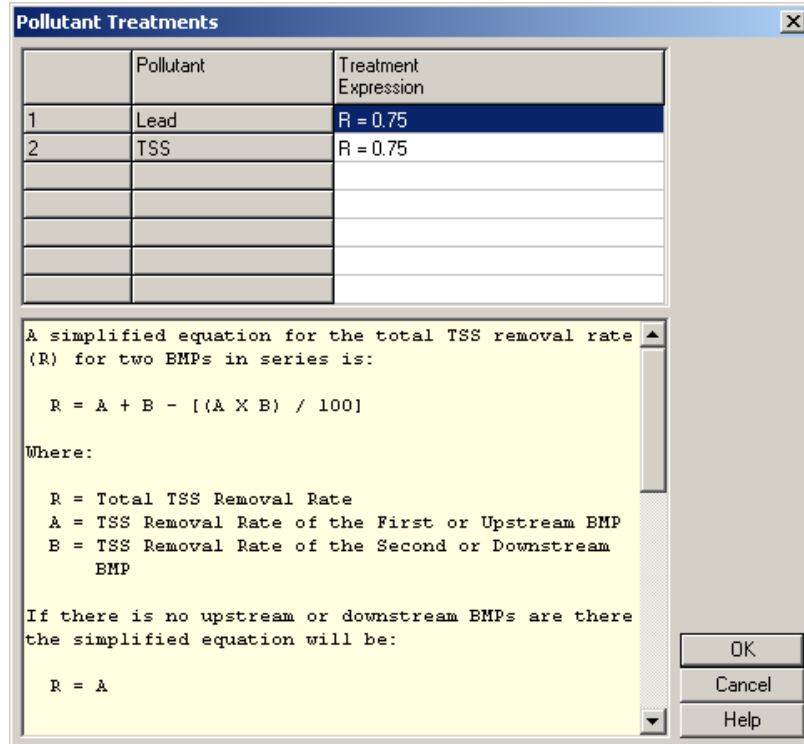

Figure 10.21 The Pollutant Treatments dialog box

This dialog box displays the pollutants defined for the project, allowing a treatment expression for each pollutant to be defined for the current node. Pollutant treatment and removal from the flow streams entering any drainage system node is modeled by assigning a set of treatment functions to the node.

A treatment function can be any well-formed mathematical expression involving:

- The pollutant concentration of the mixture of all flow streams entering the node (use the pollutant name to represent a concentration)
- The removals of other pollutants (use $R_{\text{pollutant}}$ prefixed to the pollutant name to represent removal)
- Any of the following process variables:

$FLOW$ = flow rate into node (in user-defined flow units)

$DEPTH$ = water depth above node invert (ft or m)

$AREA$ = node surface area (ft² or m²)

DT = routing time step (sec)

HRT = hydraulic residence time (hours)

The result of the treatment function can be either a concentration (denoted by the letter C) or a fractional removal (denoted by the letter R). For example, a first-order decay expression for BOD exiting from a detention pond might be expressed as:

$$C = BOD * \exp(-0.05 * HRT)$$

TSS Removal Example

A simplified equation for the total TSS removal rate (R) for two BMPs in series is:

$$R = A + B - [(A \times B) / 100]$$

where:

R = Total TSS removal rate

A = TSS removal rate of the first (or upstream) BMP

B = TSS removal rate of the second (or downstream) BMP

If there is no upstream or downstream BMPs, the simplified equation will be:

$$R = A$$

where:

R = Total TSS removal rate

A = TSS removal rate

For example, if the TSS removal rate is 75% of present TSS concentration (such as a bioswale), the equation will be:

$$R = 0.75$$

Also if Pollutant 2 is a co-pollutant of Pollutant 1, then the removal equation for Pollutant 2 will be:

$$R = A * R_{\text{Pollutant 1}}$$

where:

R = Total Pollutant 2 removal rate

A = Fractional removal rate

For example, if Lead is a co-pollutant of TSS and Lead removal is 20% of TSS removal then the removal equation for Lead will be:

$$R = 0.2 * R_{\text{TSS}}$$

Sanitary Time Patterns

The Sanitary Time Patterns dialog box, as shown in the following figure, is displayed when a new sanitary (dry weather flow) time pattern is created or an existing sanitary time pattern is selected for editing. Select **INPUT** ► **SANITARY TIME PATTERNS** or double-click the **SANITARY TIME PATTERNS**  icon from the data tree to display the Sanitary Time Patterns dialog box.

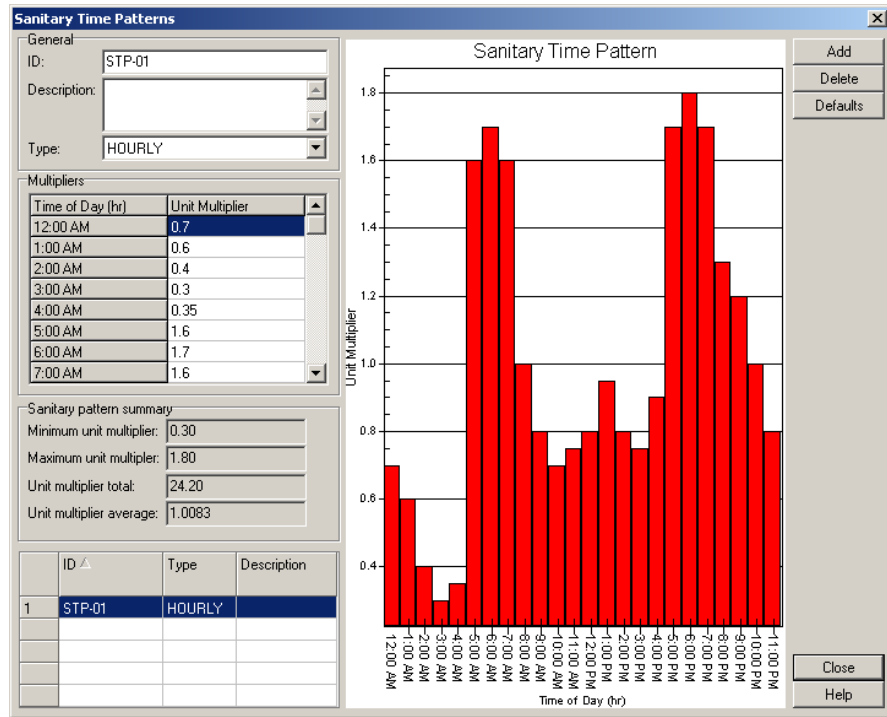

Figure 10.22 The Sanitary Time Patterns dialog box

Time pattern data allow any type of dry weather flow (typically sanitary flow) to vary in a periodic fashion. They consist of a set of adjustment factors applied as multipliers to a baseline dry weather flow rate or pollutant concentration.

The different types of time pattern data include:

- *Monthly* - one multiplier for each month of the year
- *Daily* - one multiplier for each day of the week
- *Hourly* - one multiplier for each hour from 12 AM to 11 PM
- *Weekend* - hourly multipliers for weekend days

Each time pattern must have a unique name and there is no limit on the number of patterns that can be created. Each dry weather inflow (either flow or quality) can have up to four patterns associated with it, one for each type listed above.

To select a sanitary time pattern, scroll through the displayed table and click the row containing the sanitary time pattern of interest. The provided data entry fields will then display information describing the selected sanitary time pattern. To add a new sanitary time pattern, click the Add button and then enter the appropriate information in the data fields. To delete a sanitary time pattern, select the sanitary time pattern from the table and then click the Delete button. To set the sanitary time pattern to a default pattern corresponding to typical residential use, click the Defaults button.

The following data are used to define a sanitary time pattern:

Time Pattern ID

Enter the unique name (or ID) that is to be assigned to the sanitary time pattern being defined. This name can be alphanumeric (i.e., contain both numbers and letters), can contain spaces, is case insensitive (e.g., *ABC = abc*), and can be up to 128 characters in length. Therefore, the assigned name can be very descriptive, to assist you in identifying different sanitary time patterns.

Description (optional)

Enter an optional description that describes the sanitary time pattern being defined.

Type

From the drop-down list, select the time pattern type being defined.

Unit Multipliers

Enter a value for each unit multiplier for each time pattern type. The number and meaning of the multipliers change with the time pattern type being defined:

- Monthly** One multiplier for each month of the year
- Daily** One multiplier for each day of the week
- Hourly** One multiplier for each hour from 12 midnight to 11 PM
- Weekend** Same as for HOURLY except applied to weekend days

Demand Pattern Summary

This section of the dialog box summarizes the data defined for the current sanitary time pattern.

Minimum Unit Multiplier

This read-only field shows the minimum unit multiplier value defined in the current sanitary time pattern.

Maximum Unit Multiplier

This read-only field shows the maximum unit multiplier value defined in the current sanitary time pattern.

Unit Multiplier Total

This read-only field shows the total of all the unit multipliers for the current sanitary time pattern.

Unit Multiplier Average

This read-only field shows the average of all the unit multipliers for the current sanitary time pattern. Generally, this average should be near 1.0.

Recommended Unit Multiplier Average





In order to maintain an average baseline sanitary (dry weather) flow or pollutant concentration at its specified value (as defined in the Inflows dialog box), the unit multipliers for a pattern should average to 1.0.

Right-Click Context Menu

Right-click the data table to display a context menu. This menu contains commands to cut, copy, and paste selected cells in the table. The table values can be highlighted and copied to the clipboard for pasting into Microsoft Excel. Similarly, Excel data can be pasted into the unit multiplier data table.

Time Series

The Time Series dialog box, as shown in the following figure, is displayed when a new time series is created or an existing time series is selected for editing. Select **INPUT ► TIME SERIES** or double-click the **TIME SERIES**  icon from the data tree to display the Time Series dialog box. This dialog box can also be displayed by clicking the  browse button from the **TIME SERIES** data field in the Outfalls, Rain Gages, Climatology, External Inflows, and External Inflows for Node dialog boxes when defining a time series.

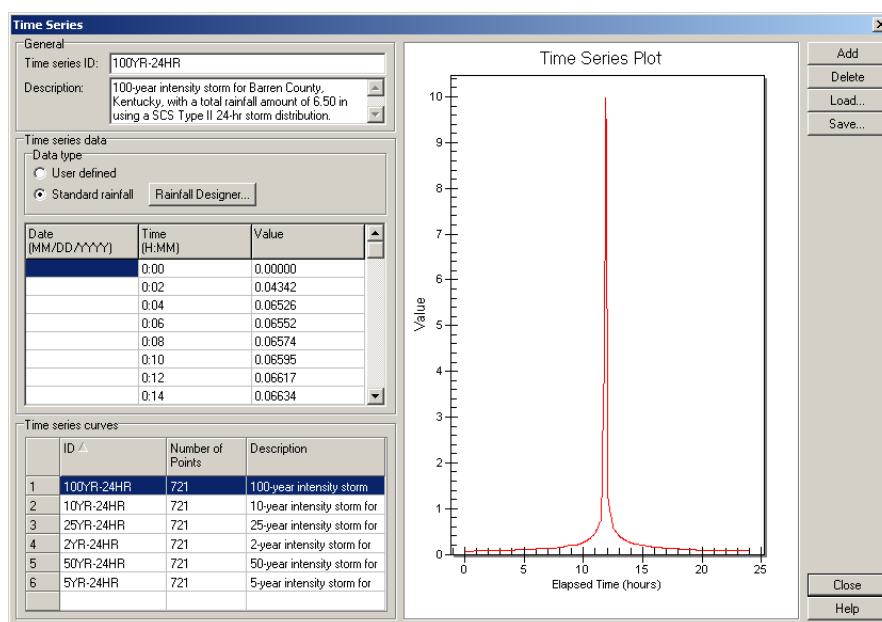

Figure 10.23 The Time Series dialog box

Time series data are used to describe how certain element properties vary with time. Time series can be used to describe:

- Rainfall data
- Water stage at outfall nodes
- Temperature data
- Evaporation data
- External inflow hydrographs at drainage system junction nodes
- External inflow pollutographs at drainage system junction nodes
- Control settings for pumps and flow regulators

Each time series must be given a unique name and can be assigned any number of time value data pairs. Time can be specified either as hours from the start of a simulation or as an absolute date and time-of-day.

To select an existing time series, scroll through the time series curves table and click the row containing the time series of interest. The provided data definition table will then display time versus value describing the selected time series. To add a new time series, click the Add button and then enter the appropriate time series data in the data definition table. To delete a time series, select the time series from the time series table and then click the Delete button.

The following values are used to define the time series:

Time Series ID

Enter the unique name (or ID) that is to be assigned to the time series being defined. This name can be alphanumeric (i.e., contain both numbers and letters), can contain spaces, is case insensitive (e.g., *ABC = abc*), and can be up to 128 characters in length. Therefore, the assigned name can be very descriptive, to assist you in identifying different time series.

Description (optional)

Enter an optional description that describes the time series being defined.

Date (optional)

This column provides the date (month/day/year format) of the time series values. This data is only required at points in time where a new date occurs.

Time

This column represents the time of the specified entry. If dates are used in the time series, then enter the military time of day for each time series value (as hours:minutes or decimal hours). If dates are not used, enter time as hours since the start of the simulation.

Value

The corresponding time series numerical value.

Time & Date Formats

Note that there are two methods for describing time series data:

- As calendar date/time of day (which requires that at least one date, at the start of the series, be entered in the **DATE** column).
- As elapsed hours since the start of the simulation (where the **DATE** column remains empty).

Right-Click Context Menu

Right-click the data table to display a context menu. This menu contains commands to cut, copy, insert, and paste selected cells in the table as well as options to insert or delete rows. The table values can be highlighted and copied to the clipboard for pasting into Microsoft Excel. Similarly, Excel data can be pasted into the time series table.

Rainfall Time Series Data

For rainfall time series, it is only necessary to enter periods with non-zero rainfall amounts. The software interprets the rainfall value as a constant value lasting over the recording interval specified for the rain gage that utilizes the time series. For all other types of time series, the software uses linear interpolation to estimate values at times that fall in between the recorded values.

Extrapolation of Time Series Data

For times that fall outside the range of the time series, the software will use a value of 0 for rainfall and external inflow time series, and either the first or last series value for temperature, evaporation, and water stage time series.

Microsoft Excel Data

Microsoft Excel does an excellent job of editing time series data. However, in order to enter time series data longer than 24 hours it is necessary to format the Excel cell data in time format of HH:MM:SS. In that way, you can have time data longer than 24 hours without Excel resetting the hour back to 0. As shown in the following figure, while in Excel, right-click the cells containing the time data and select **FORMAT CELLS** from the displayed context menu. Choose the format of **HH:MM:SS** within the Format Cells dialog box. Then, when you cut and paste the Excel time series data into the Time Series dialog box.

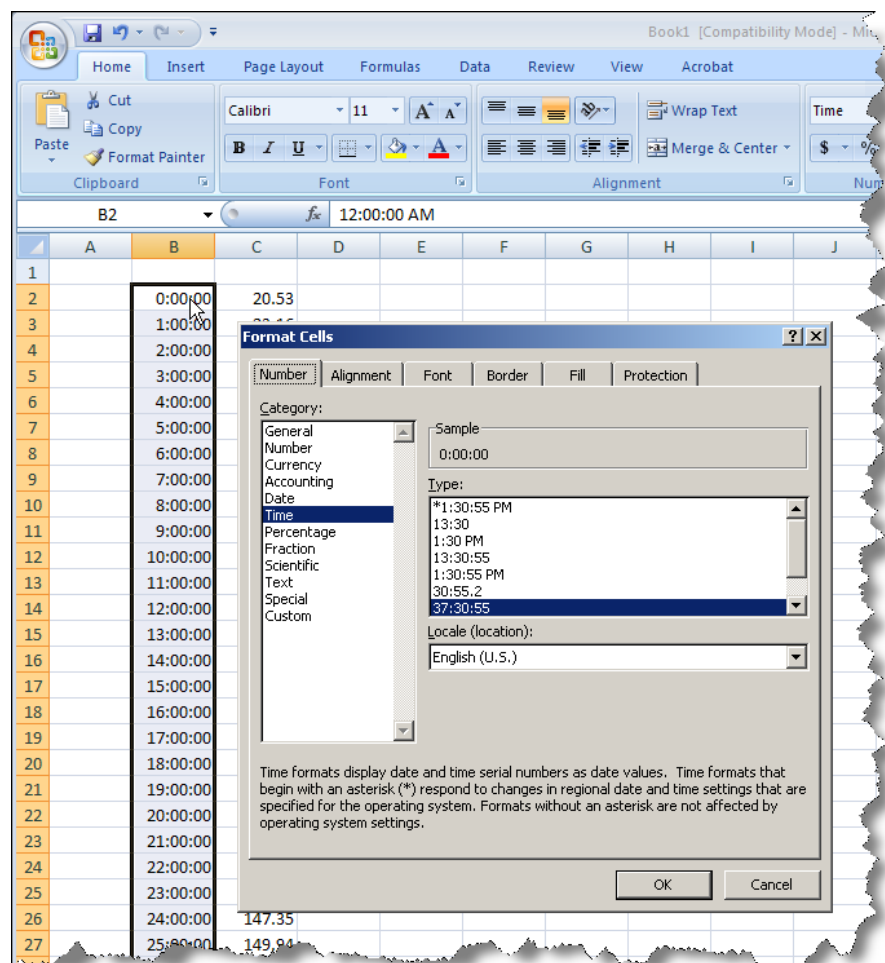

Figure 10.24 Formatting time series data within Microsoft Excel for longer than 24 hours, to allow copying and pasting into the software

Importing and Exporting Time Series Data

Click the Load button to import a time series that was previously saved to an external file or click the Save button to export the current time series data to an external file.

Time Series File Format

Time series files are external text files that contain data for the network's time series elements. Examples of time series data include rainfall, evaporation, inflows to nodes of the drainage system, and water stage at outfall boundary nodes. Normally these data are entered and edited through the Time Series dialog box. However this data can be created outside of the software, using a text editor or spreadsheet, and then imported as an external time series file.

The format of a time series file consists of two lines of descriptive text followed by the actual time series data, with one time series value per line. Typically, the first text line identifies the time series and the second line includes a detailed description of the time series.

Time series values can either be in date / time / value format or in time / value format, where each entry is separated by one or more spaces or tab characters. For the date / time / value format, dates are entered as month/day/year (e.g., 7/21/2004) and times as 24-hour military time (e.g., 8:30 pm is 20:30). After the first date, additional dates need only be entered whenever a new day occurs. For the time / value format, time can either be decimal hours or military time since the start of a simulation (e.g., 2 days, 4 hours and 20 minutes can be entered as either 52.333 or 52:20). An example of a time series file is shown in the following figure.

```
Time Series Data
<optional description goes here>
07/01/2003 00:00 0.00000
           00:15 0.03200
           00:30 0.04800
           00:45 0.02400
           01:00 0.0100
07/06/2003 14:30 0.05100
           14:45 0.04800
           15:00 0.03000
           18:15 0.01000
```

Figure 10.25 Example time series file format

When preparing rainfall time series files, it is only necessary to enter periods with nonzero rainfall amounts. The software interprets the rainfall value as a constant value lasting over the recording interval specified for the rain gage which utilizes the time series. For all other types of time series, the software uses linear interpolation to estimate values at times that fall in between the recorded values.

Importing and Exporting

11

Autodesk Storm and Sanitary Analysis can import and export data in a variety of file formats. This allows you to quickly share data with other software.

Supported File Formats

The software can use the following file formats for importing and exporting background raster image data and network model data:

- Importing and exporting of AutoCAD DWG and DXF files
- Importing of JPEG and TIFF aerial orthophoto images and maps
- Exporting of Microsoft Enhanced Metafiles
- Importing and exporting of Hydraflow Storm Sewers files
- Importing and exporting of LandXML files
- Importing and exporting of GIS shapefiles
- Importing and exporting of EPA SWMM version 5.0 input data files
- Importing and exporting of XPSWMM input data files
- Exporting of network coordinate data as an ASCII text file
- Merging multiple network models into a single model
- Importing and exporting of Microsoft Excel spreadsheets

The software allows CAD drawing files of streets, parcels, and buildings; and scanned JPEG and TIFF aerial orthophoto images and maps to be imported and displayed as a background image. This allows you to quickly digitize a network model, confirm the network layout, or enhance the output modeling results. In addition, the drainage network can be exported as an AutoCAD drawing file.

In addition, AutoCAD Hydraflow Storm Sewers files, LandXML files, GIS shapefiles, EPA SWMM input files, and XPSWMM input files can be imported and exported, allowing the software to share data with other applications without requiring you to re-enter the data.

Multiple network models can be merged together, allowing you to break up a large project into separate sub-projects in order to expedite the model setup and development with additional staff.

Microsoft Excel spreadsheet data can be quickly placed into a network model. Also, the software can export out the entire network model data as an Excel spreadsheet.

Importing and Exporting AutoCAD Drawings

Stormwater and wastewater sewer network AutoCAD drawings can be imported and exported from Autodesk Storm and Sanitary Analysis. This allows existing drawing files to be quickly integrated into the analysis and design process, as well as any designed network to be exported as a drawing file. These capabilities can greatly assist you in performing your stormwater and wastewater engineering work as well as in creating output documentation for the completed project.

Importing AutoCAD Drawings

The software can import AutoCAD DWG or DXF drawing files as a background image in the Plan View. The drawing file might be a street map, utility map, topographic map, site development plan, or any other relevant drawing. For example, using a street map would simplify the process of adding sewer lines to the project since one could essentially digitize the drainage network junctions and pipes directly on top of the drawing.

To import a DWG or DXF drawing file, select **FILE ► IMPORT ► LAYER MANAGER (DWG/DXF/TIF/MORE)**. The Layer Manager dialog box will then be displayed, as shown in the following figure.

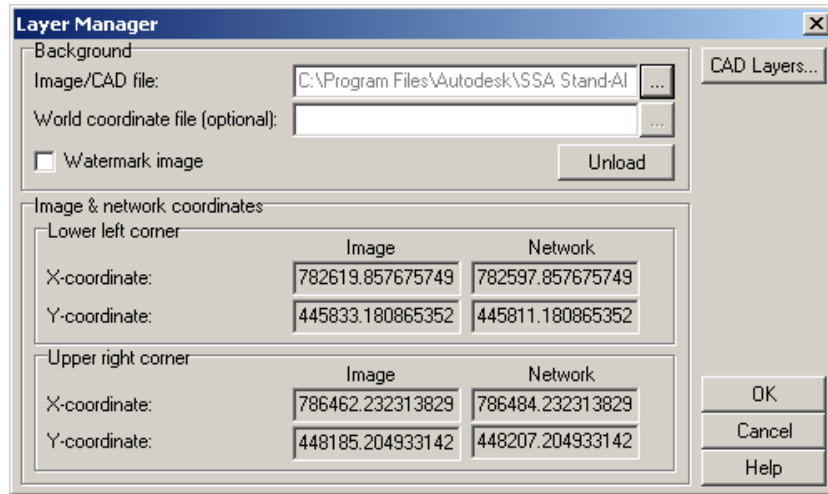

Figure 11.1 The Layer Manager dialog box can be used to load and unload a DWG or DXF drawing file

Alternatively, you can import a DWG or DXF drawing file by selecting **VIEW ► LAYER MANAGER**, and the Layer Manager dialog box will then be displayed. From the Layer Manager dialog box you can then browse and select the DWG or DXF drawing file to load.

Drawing Layer Control

Note that the you can control the visibility and colors of the CAD drawing layers. That allows you to hide layers or change layer colors without having to re-open the CAD drawing within AutoCAD and then re-save the drawing file. From the Layer Manager dialog box, click the CAD Layers button. The CAD Layers dialog box is then displayed, as shown in the following figure. This dialog box allows you to change layer visibility and color settings.

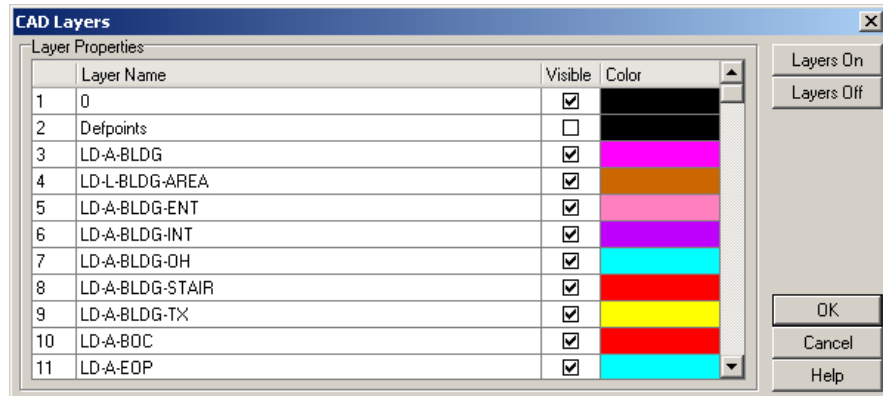

Figure 11.2 The visibility and colors of the CAD drawing layers can be controlled

Importing Multiple Drawings

If there is already a CAD drawing loaded, the software will replace the existing drawing with the drawing being imported. Currently, the software cannot merge the incoming CAD drawing with the CAD drawing already loaded.

Link to Original Drawing File

When the drainage project is saved, a link to the original CAD drawing file is saved in the project file. Then, the next time the project file is opened, the CAD drawing file is reloaded.

If the original CAD drawing file is moved, the software will not be able to reference the drawing file and will not be able to display the CAD drawing as a background. You will need to re-import the CAD drawing file.

Unloading a Drawing File

To unload a currently loaded DWG or DXF file, select **VIEW ► LAYER MANAGER**. The Layer Manager dialog box is then displayed, as shown previously in Figure 11.1. From the Layer Manager dialog box, click the Unload button.

Exporting AutoCAD Drawings

The software allows you to export a CAD drawing file of the Plan View or Profile Plot. (See the section titled *CAD Exporting* on page 138 for further information on exporting a profile plot to a CAD drawing file.)

The exported Plan View CAD drawing file can then be loaded into AutoCAD. Map annotation, such as node and link ID labels, will be exported along with user-defined map annotation if these items are currently being displayed in the Plan View.

If a CAD drawing is already loaded, only the network data is exported. The currently loaded CAD drawing will not be exported.

The software places each element type on its own layer, allowing you to control the visibility of various network element types.

To export the Plan View as an AutoCAD DWG or DXF file, select **FILE ► EXPORT ► CAD EXPORT**. A Save As dialog box is displayed, allowing you to specify the name and the directory path (folder) for saving the file.

Importing Background Map & Orthophoto Images

The software can import geo-referenced JPEG and TIFF image files as a background in the Plan View. The imported image might be an aerial orthophoto or scanned USGS quadrangle map. The software supports both GeoTIFF image files and image files with world coordinate files.

To import a JPEG and TIFF background image file, select **FILE ► IMPORT ► LAYER MANAGER (DWG/DXF/TIF/MORE)**. The Layer Manager dialog box is then displayed, as shown in the following figure.

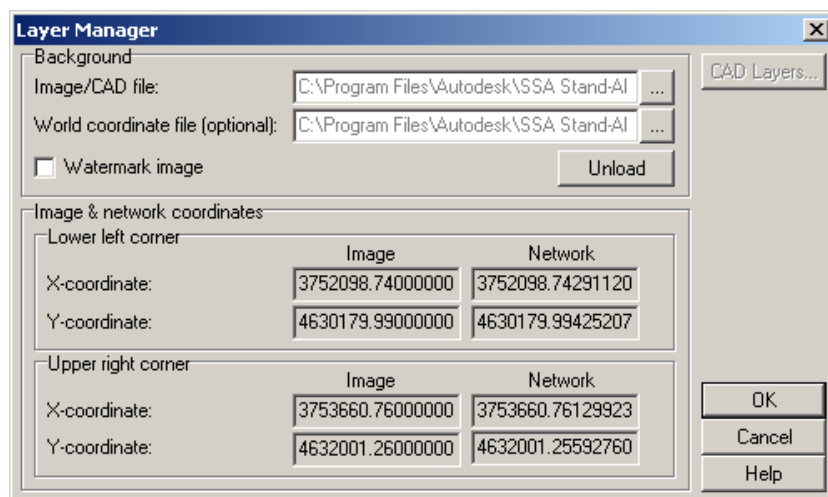

Figure 11.3 The Layer Manager dialog box can be used to load and unload an image file and corresponding world coordinate file

Alternatively, you can select **VIEW ► LAYER MANAGER**. The Layer Manager dialog box is then displayed. From the Layer Manager dialog box you can then browse and select the image file and corresponding world coordinate file to import.

Geo-Referenced Images

Some TIFF images have the coordinate system embedded in the file. These are called GeoTIFF files. Also, some images have a separate coordinate file called a world file or world coordinate file. A TIFF world coordinate file has a file extension of **.TFW**. A JPEG world coordinate file has a file extension of **.JPW**.

When a geo-referenced image file is opened, the software automatically registers the image to the real world coordinates specified. If a separate world coordinate file is used, the software will automatically load it if the world file has the same filename prefix as the image file and both files are in the same folder.

Coordinate Transformation

Note that the software will not perform any coordinate transformation or unit conversion if the georeferenced image file being imported has been defined in a different coordinate system than what the network model is being developed in.

Any georeferenced image coordinate transformation must be performed prior to importing.

Importing Multiple Image Files

If there is already image data in memory, the software will replace the existing data with the data being imported. Currently the software cannot manage and display multiple image files.

Link to Original Image File

When the drainage project is saved, a link to the image is saved in the project file, along with the image coordinate registration information. Then, the next time the project file is opened, the image is re-registered to the same coordinates as previously. The original image file and world file (if one exists) are not altered.

If the original image file is moved, the software will not be able to reference the image file and will not be able to display the image as a background. You will need to re-import the background image file.

Unloading an Image File

To unload a currently loaded image file, select **VIEW ► LAYER MANAGER**. The Layer Manager dialog box is then displayed, as shown in Figure 11.3. From the Layer Manager dialog box, click Unload.

Watermark Display of Image

Selecting the check box **WATERMARK IMAGE** causes the displayed background image to be lightened slightly so that the defined drainage network data is more visible.

Image and Network Coordinates

Note that you can see the coordinates of the lower-left and upper-right corners of image to being imported in the Layer Manager dialog box. The column labeled **NETWORK** represents the X-Y coordinate extents of the network data already present in the model.

Units for Digitizing

If you are going to use the background image for digitizing the network, by defining the units to be used for digitizing the software will then use the coordinates of the network elements you digitize to compute distances and areas. The conduit length units (feet or meters) depend on whether flow units are expressed in US or metric (SI) units in the Project Options dialog box. See the section titled *Project Options* on page 163 for more information.

Exporting Windows Metafiles

The software allows you to export a Windows Enhanced Metafile of the Plan View. This file can then be imported into Microsoft Word as a vector-based drawing. This allows the exported Plan View not to lose resolution when rescaled or printed at different scales.

To export the Plan View as a Windows Enhanced Metafile, select **FILE ► EXPORT ► WINDOWS ENHANCED METAFILE**. A Save As dialog box is displayed, allowing you to specify the name and the directory path (folder) for saving the file.

Importing & Exporting Hydraflow Storm Sewers Files

In order to more seamlessly share data with AutoCAD Civil 3D, both Civil 3D and Autodesk Storm and Sanitary Analysis can import and export Hydraflow Storm Sewers files. This allows the stormwater and wastewater sewer network data to be shared. Note that only the pipe network data (i.e., manhole structures, storm drain inlets, and pipes), subbasin data that contributes runoff to junctions and storm drain inlets, and Rational Method IDF data is shared. Time series rainfall data, detention ponds, and other specialty hydrology data is not shared.

Importing Hydraflow Storm Sewers Files

To import a Hydraflow Storm Sewers file:

- 1 Select **FILE ► IMPORT ► HYDRAFLOW STORM SEWERS FILE**.

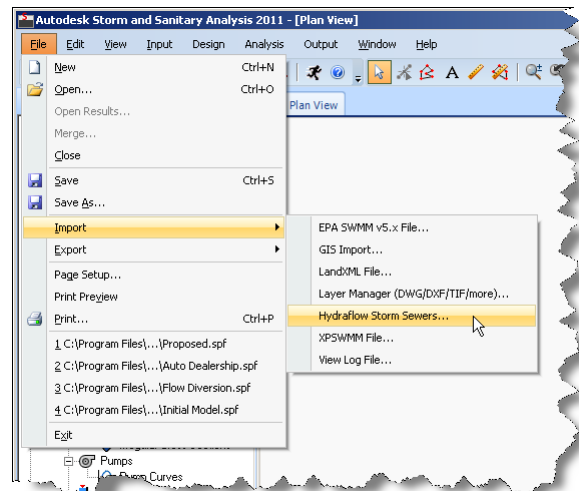

Figure 11.4 Select File ► Import ► Hydraflow Storm Sewers File

- 2 The Import Hydraflow Storm Sewers File dialog box is then displayed, allowing you to navigate to where the Hydraflow Storm Sewers file is located. Select the Hydraflow Storm Sewers file (it will have a file extension of **.STM**) and click Open.

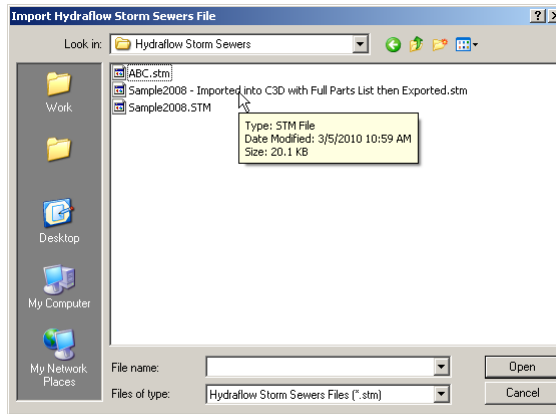

Figure 11.5 Select the Hydraflow Storm Sewers file to import

- 3 The software will then begin the process of importing the Hydraflow Storm Sewers file. Generally importing a Hydraflow Storm Sewers model only takes a few seconds—depending upon the size of the network.
- 4 After importing the Hydraflow Storm Sewers model, the software will display a log file of the import process. This log file will describe where there may have been some translation problems in converting the Hydraflow Storm Sewers model to Autodesk Storm and Sanitary Analysis. If at all possible, the software will attempt to resolve any conversion issues and inform you of these issues. However, this log file should be reviewed for any concerns that were identified.

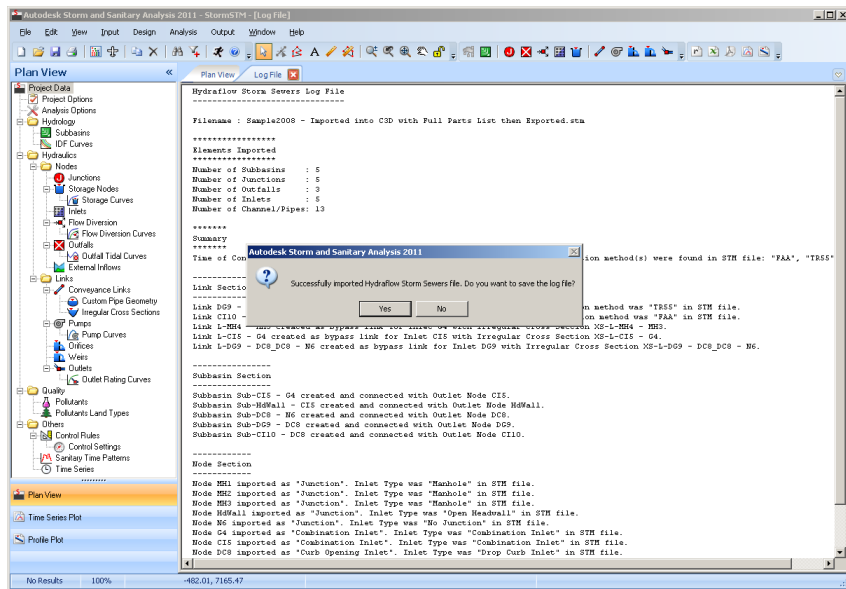

Figure 11.6 A log file is generated after importing the Hydraflow Storm Sewers model, describing where there may have been some translation problems in converting the Hydraflow Storm Sewers model to Autodesk Storm and Sanitary Analysis

- 5 After the Hydraflow Storm Sewers model has been imported, you can then start to work on the network model using the software’s element editors, etc.

Hydraflow Import Considerations

The **IMPORT HYDRAFLOW STORM SEWERS FILE** command can be used to create a new project, or update or merge with an existing project. The following list details the assumptions and conversions that occur when importing a Hydraflow Storm Sewers file.

- Hydraflow Storm Sewers *lines* are imported as Autodesk Storm and Sanitary Analysis *conveyance links* with the same shape and size.
- Hydraflow *inlets* and *junctions* import as either Autodesk Storm and Sanitary Analysis *junctions, inlets, or outfalls*.
- Hydraflow *manholes* and *headwalls* are imported as Autodesk Storm and Sanitary Analysis *junctions*.
- Hydraflow *inlet types* are converted to an Autodesk Storm and Sanitary Analysis *storm drain* that is defined as an FHWA HEC-22 generic inlet type.
- Hydraflow *outfalls* import as Autodesk Storm and Sanitary Analysis *outfalls*.
- Hydraflow *Inlet IDs* import as Autodesk Storm and Sanitary Analysis *Inlet IDs, Junction IDs, or Outfall IDs*.
- Hydraflow *Line IDs* import as Autodesk Storm and Sanitary Analysis *Conveyance Link IDs*.
- Hydraflow *Inlet/Junction Bypass Target* is converted to an Autodesk Storm and Sanitary Analysis *Irregular Cross Section Conveyance Link* between the storm drain inlet and the Bypass Target node using the Hydraflow *Gutter Details* together with the *Gutter Spread Warning* width.
- Hydraflow *Bypass Targets* with a value of **OFFSITE** will be imported as an Autodesk Storm and Sanitary Analysis *outfall* with an element ID containing the prefix **OFFSITE-**. Each outfall will be drawn at an offset to its connecting inlet.
- Hydraflow *drainage areas* import as Autodesk Storm and Sanitary Analysis *subbasins*. These subbasins will inherit the Hydraflow *Inlet ID, runoff coefficients*, and will be drawn as schematic subbasins at an offset to the connecting inlets.
- Hydraflow *IDF curve data* is imported as Autodesk Storm and Sanitary Analysis *IDF curves*.
- Autodesk Storm and Sanitary Analysis *subbasins* will inherit the time of concentration source data from the Hydraflow Tc Method worksheets from either the FAA or TR-55 Tc methods. If both Tc methods (i.e., FAA and TR-55) are specified in the Hydraflow project, upon import Autodesk Storm and Sanitary Analysis subbasins will be defined with a user-defined time of concentration value that corresponds to the computed Tc method defined for each drainage area in Hydraflow. Note that Autodesk Storm and Sanitary Analysis does not allow more than one time of concentration method to be used within a project.
- Importing a Hydraflow STM file into an already existing Autodesk Storm and Sanitary Analysis project will cause common data to be updated. Elements that are specific to the Autodesk Storm and Sanitary Analysis project are not impacted.
- After importing a Hydraflow project, a log file is created by Autodesk Storm and Sanitary Analysis. This file contains a detailed description of the assumptions and conversion issues that were encountered during the import process. You should review this file for any potential concerns. Modifications may be required to the imported model.

Exporting Hydraflow Storm Sewers Files

To export a Hydraflow Storm Sewers file of the currently loaded network model:

- 1 Select **FILE** ► **EXPORT** ► **HYDRAFLOW STORM SEWERS FILE**.

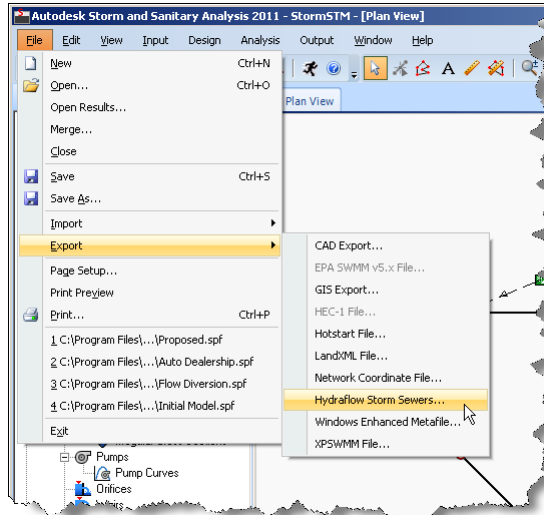

Figure 11.7 Select File ► Export ► Hydraflow Storm Sewers File

- 2 The Export Hydraflow Storm Sewers File dialog box is displayed, allowing you to navigate to where you want to save the Hydraflow Storm Sewers file. Define the file name of the Hydraflow Storm Sewers file (it should have a file extension of **.STM**) and click Save.

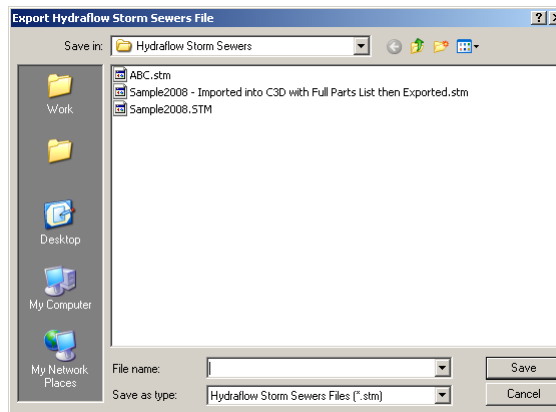



















Figure 11.8 Define the file name of the Hydraflow Storm Sewers file to export

- 3 The software will then begin the process of exporting the Hydraflow Storm Sewers file. Generally exporting a Hydraflow Storm Sewers model only takes a few seconds—depending upon the size of the network.
- 4 Note that those items that are not supported by Hydraflow Storm Sewers that are unique to Autodesk Storm and Sanitary Analysis are not exported.

Hydraflow Export Considerations

The **EXPORT HYDRAFLOW STORM SEWERS FILE** command can be used to export the current project as a Hydraflow STM file. The following list details the assumptions and conversions that occur when exporting to a Hydraflow Storm Sewers file.

- Autodesk Storm and Sanitary Analysis can export any project to a Hydraflow STM file.
- Autodesk Storm and Sanitary Analysis *nodes* export as Hydraflow *inlets*, as detailed below:

Autodesk Storm and Sanitary Analysis Nodes		Hydraflow Inlets	
	Junction	Manhole	
	Inlet - FHWA Combination	Combination Inlet	
	Inlet - FHWA Curb	Curb Inlet	
	Inlet - Circular	Grate Inlet	
	Inlet - Rectangular	Grate Inlet	
	Inlet - Median & Ditch	Drop Grate	
	Outfall	Outfall	
	Diversion	Manhole	
	Storage Node	Manhole	

- Autodesk Storm and Sanitary Analysis pipe and culvert *conveyance links* export as Hydraflow *pipes* of circular, elliptical, or rectangular (box) shape and dimension.
- Autodesk Storm and Sanitary Analysis *open channels*, *weirs*, *orifices*, *outlets*, and *pumps* export as Hydraflow circular *pipes*.
- Autodesk Storm and Sanitary Analysis on grade storm drain inlet's roadway/gutter bypass *conveyance links* export as Hydraflow *gutter lines*.
- Autodesk Storm and Sanitary Analysis on sag storm drain *inlets* export as Hydraflow *inlets* set to **ON SAG**.
- Autodesk Storm and Sanitary Analysis circular storm drain *inlets* export as Hydraflow rectangular grate *inlets* with an equivalent opening area.
- Autodesk Storm and Sanitary Analysis *subbasin* physical properties of area, time of concentration, and runoff coefficient export as the drainage area, time of concentration, and runoff coefficient associated with the Hydraflow downstream *pipe*.
- In Autodesk Storm and Sanitary Analysis, if two or more *subbasins* are connected to a single *node*, then a combined area, the highest calculated time of concentration, and composite runoff coefficient are exported to the Hydraflow downstream *pipe*.
- Autodesk Storm and Sanitary Analysis export is limited to those items that can be translated to Hydraflow to maintain the network topology. Autodesk Storm and Sanitary Analysis storage curves, tidal curves, rating curves, time series, and water quality data is not exported to Hydraflow.

Importing & Exporting LandXML Files

Autodesk Storm and Sanitary Analysis allows you to share stormwater sewer and sanitary sewer design data with AutoCAD Civil 3D. Using LandXML, the software can directly import Civil 3D design data as a stormwater or sanitary sewer model. Then, as you make changes to the network model, such as pipe sizes, invert elevations, sump elevations, and rim elevations, the updated changes can then be exported back to AutoCAD Civil 3D and merged with the original design.

Importing a LandXML File

To import a LandXML file:

- 1 Select **FILE** ► **IMPORT** ► **LANDXML FILE**.

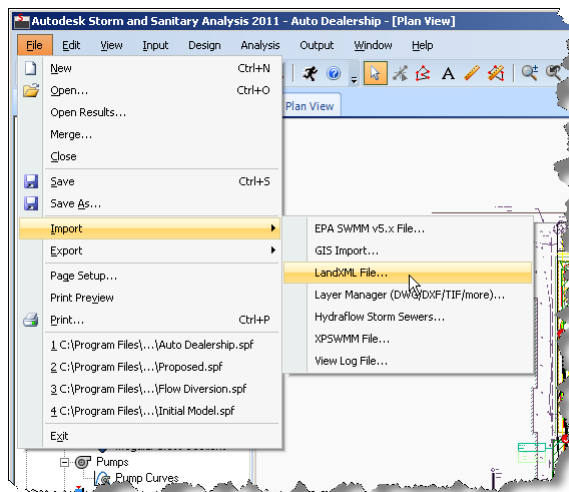

Figure 11.9 Select File ► Import ► LandXML File

- 2 The Import LandXML File dialog box is then displayed, allowing you to navigate to where the LandXML data file is. Select the LandXML data file and then click Open.

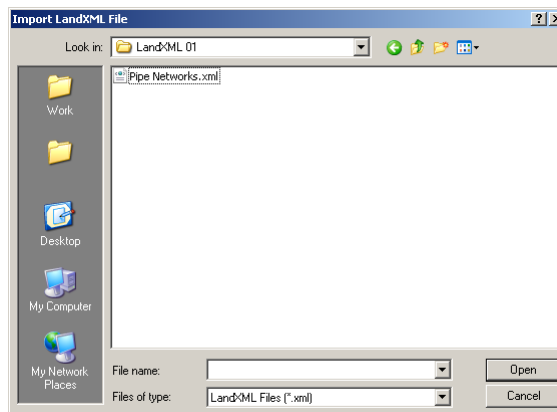

Figure 11.10 Select the LandXML file to import

- 3 The software will then import the LandXML data and create a network model from this data.

Exporting a LandXML File

To export a LandXML file:

- 1 Select **FILE** ► **EXPORT** ► **LANDXML FILE**.

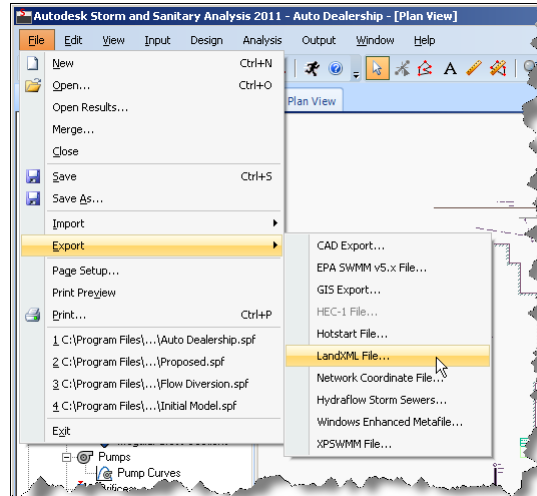

Figure 11.11 Select File ► Export ► LandXML File

- 2 The Export LandXML File dialog box is displayed, allowing you to navigate to where you want the LandXML data file saved. Define the file name of the LandXML file and then click Save.

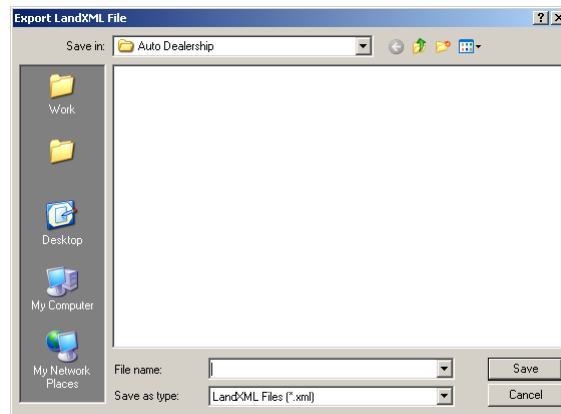

Figure 11.12 Define the file name of the LandXML file to export

- 3 The LandXML data is then exported from the currently loaded network model. This data can then be imported into AutoCAD Civil 3D.

Importing & Exporting GIS Shapefiles

Spatial data of the stormwater and wastewater sewer network can be shared with most GIS databases, allowing the software to be part of the stormwater and wastewater management and planning system. These capabilities can greatly assist in the decision-making processes for network asset inventory, rehabilitation requirements, and financial planning. The software can intelligently import GIS shapefiles, using attribute mapping and geocoding. Also, analysis solution results can be exported as GIS shapefiles, allowing locations of CSO and SSO points,

manhole overflows, pipe surcharging, and floodplain flooding to be quickly identified.

Importing GIS Shapefiles

To import GIS shapefiles:

- 1 Select **FILE** ► **IMPORT** ► **GIS IMPORT**.

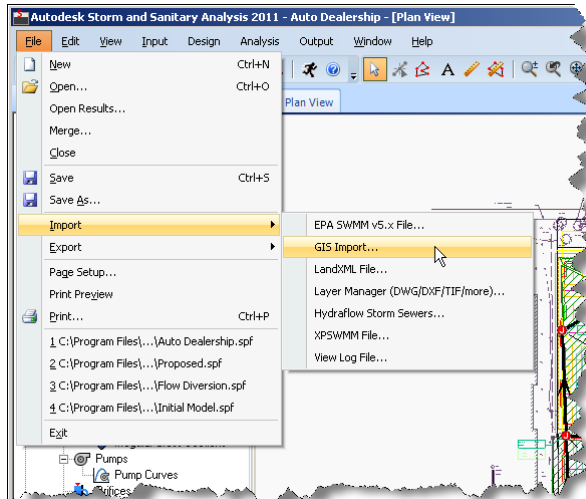

Figure 11.13 Select File ► Import ► GIS Import

- 2 The GIS Import Wizard is then displayed. The wizard will assist you in importing node, arc, and polygon shapefiles containing stormwater and/or wastewater network data.

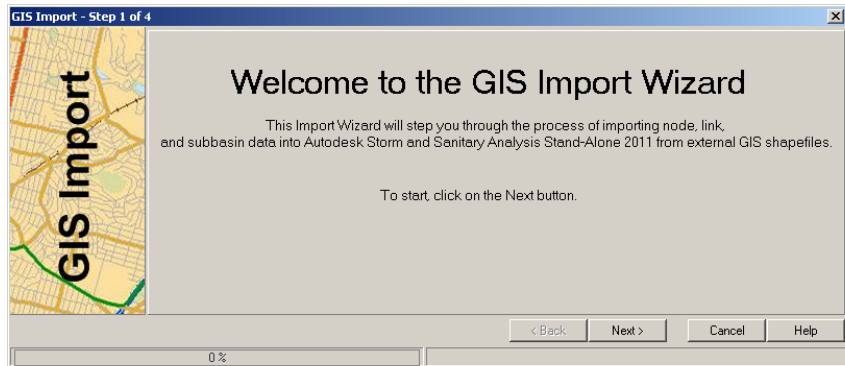

Figure 11.14 The GIS Import Wizard will step you through the process of importing network data from GIS shapefiles

- 3 After the GIS Import Wizard is displayed, click the Next button to begin the import process. The Pipes tab is displayed, defining the various fields that are available for mapping of external arc (line) shapefile fields.

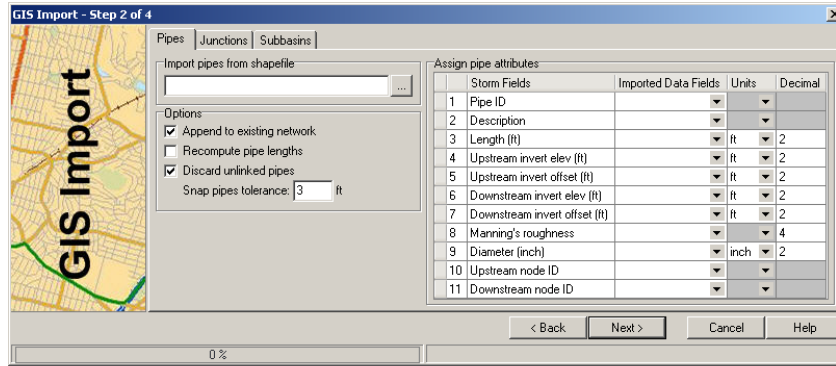

Figure 11.15 The Pipes tab defines the fields available for mapping of external arc shapefile fields

- From the Pipes tab, click the browse button. An Open dialog box is displayed, allowing you to select the pipe shapefile to import. After selecting the shapefile to import, click OK.

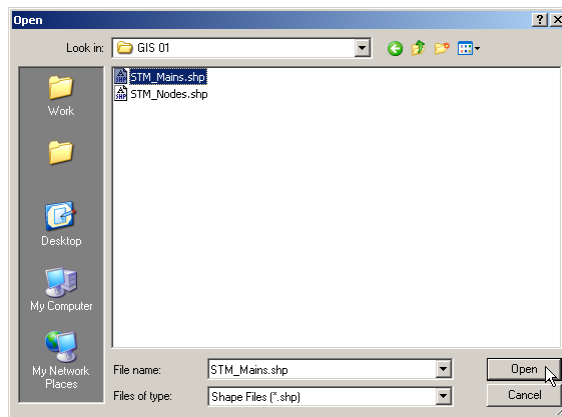

Figure 11.16 Select the arc (line) shapefile to import for pipe data

- The software will attempt to automatically map over any attribute data that it can to equivalent network element entities, based upon the field names contained within the selected GIS shapefile. However, if the software was unsuccessful for a particular field, select the drop-down arrow of the field that the software missed. You can then scroll through the list of available fields contained within the loaded GIS shapefile. Select the appropriate field to map.

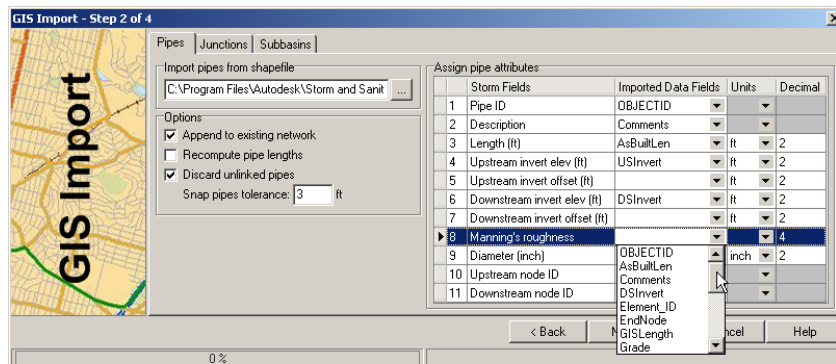

Figure 11.17 The GIS Import Wizard will automatically map over the attribute data it finds, but you can easily override what it determines

- Note that you can also specify the units for particular fields, in order to override the units that the software assumed. For example, pipe diameter might have been assumed as ft and the GIS data was actually inches. Selecting inches in the unit drop-down list then informs the software of the correct units within the GIS shapefile, and the software will then automatically perform the appropriate unit conversion upon importing the data.

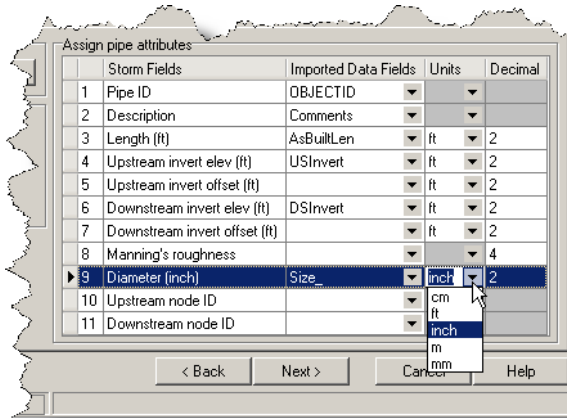

Figure 11.18 The assumed GIS data units can be changed in order to that appropriate unit conversion take place during importing

- While importing the GIS data, the software will actually round the imported data to the specified decimal precision. If required, change the decimal precision desired.
- After defining the pipe data within the GIS Import Wizard, click Next to go to the Junctions tab. Alternatively, click the Junctions tab. Then, select the appropriate shapefile and make the necessary adjustments for handling the node (point) data to be imported.

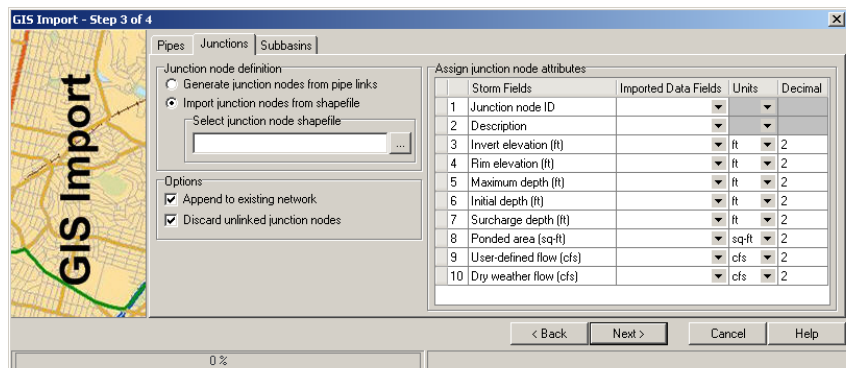

Figure 11.19 The Junctions tab defines the data fields for importing node (point) shapefiles

- Note that if there is no junction data to import, then this step can be ignored. The software will automatically generate junction data for the ends to the imported pipes.
- After defining the junction data within the GIS Import Wizard, click Next to go to the Subbasins tab. Alternatively, click the Subbasins tab. Then, select the appropriate shapefile and make the necessary adjustments for handling the polygon data to be imported.

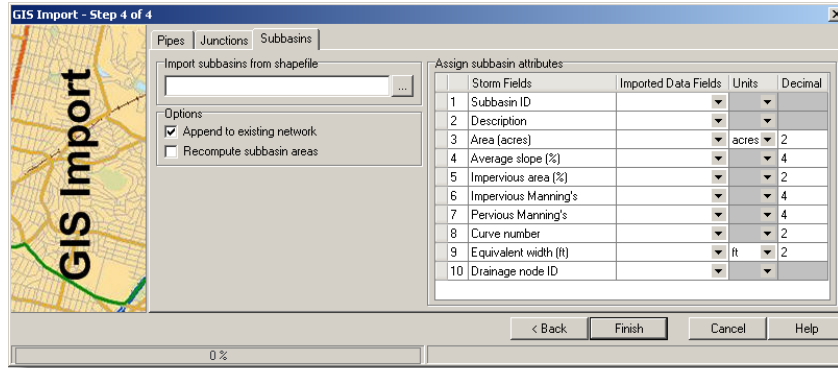

Figure 11.20 The Subbasin tab defines the data fields for importing polygon shapefiles

- 11 Note that if there is no subbasin data to import, then this step can be ignored.
- 12 After defining the subbasin data within the GIS Import Wizard, click Finish to complete the import process. The software will then import the selected GIS data and create a network model from this data.
- 13 During any point of this import process, you can backup a step or cancel the process completely.

Exporting GIS Shapefiles

To export GIS shapefiles:

- 1 Select **FILE** ► **EXPORT** ► **GIS EXPORT**.

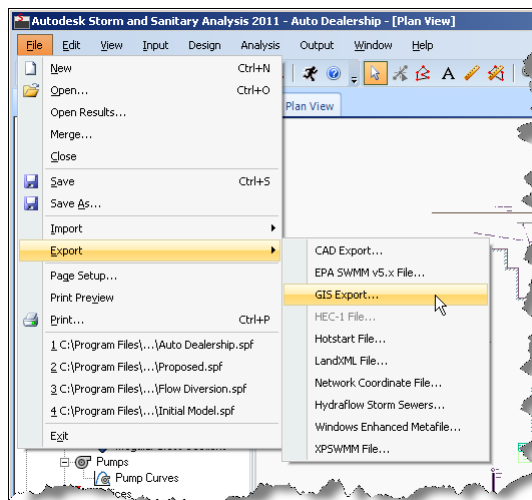

Figure 11.21 Select File ► Export ► GIS Export

- 2 The GIS Export Wizard is then displayed. The wizard will assist you in exporting stormwater and/or wastewater network data and solution results to node (point), arc (line), and polygon shapefiles.



Figure 11.22 The GIS Export Wizard will step you through the process of exporting network data to GIS shapefiles

- 3 After the GIS Export Wizard is displayed, click the Next button to begin the export process. The Options tab is displayed, defining the various fields that are available for mapping of external shapefile fields.

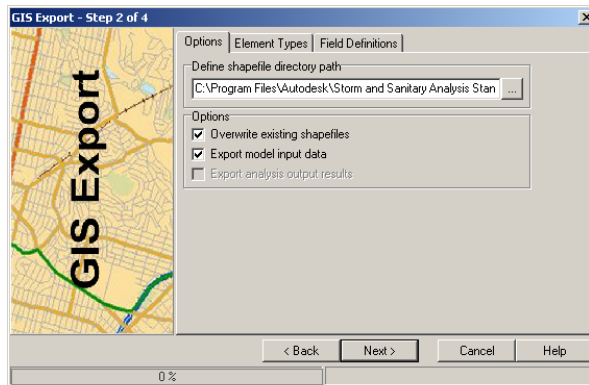

Figure 11.23 The Options tab allows you to define various options for mapping of external shapefile fields

- 4 In the Options tab, select the directory in which the shapefiles are to be created. The (...) browse button can be used to navigate to the appropriate directory. If necessary, revise the other option settings.
- 5 After defining the data within Options tab, click Next to go to the Element Types tab. Alternatively, click the Element Types tab. Then, select the appropriate element types to be exported. By default, all element types will be exported.

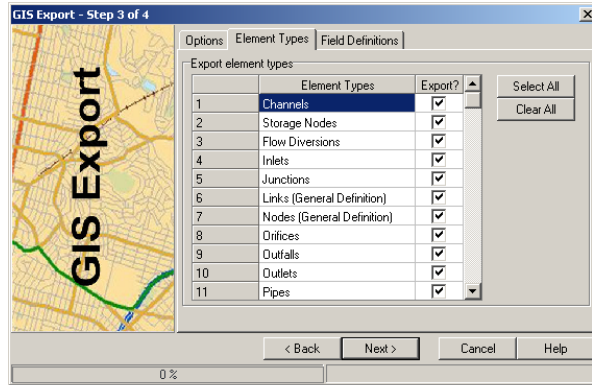

Figure 11.24 The Element Types tab allow you to control which elements should be exported

- 6 After defining the element types to be exported in the Element Types tab, click Next to go to the Field Definitions tab. Alternatively, click the Field Definitions tab.

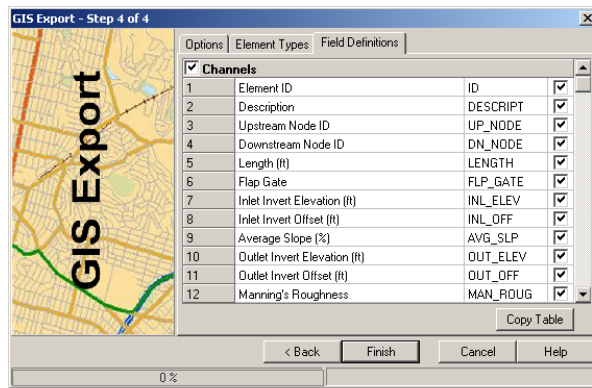

Figure 11.25 The Field Definitions tab allows you to control what network input and output data should be exported

- 7 From within the Field Definitions tab, you can limit what network input and output data should be exported. In addition, you can relabel the GIS fields to be exported.

Note that the GIS fields are limited to 8 characters and spaces are not allowed. Therefore, in order to make it easier to remember what a particular field contains, click the Copy Table button. This will copy the field definitions to the clipboard, allowing you to paste this data into a spreadsheet or ASCII file using Notepad. You can then use this table to relabel the fields within your GIS.

- 8 After defining the data to be exported within the GIS Export Wizard, click Finish to complete the export process. The software will then export the data to individual shapefiles, corresponding to specific element types.
- 9 During any point of this export process, you can backup a step or cancel the process completely.

Importing & Exporting EPA SWMM Input Data Files

Autodesk Storm and Sanitary Analysis can import and export EPA SWMM version 5.0 input data files. This provides you with the ability to take an existing stormwater model created in EPA SWMM and make modifications and additions to it. It also provides you with the enhanced features and capabilities of the software that EPA SWMM does not have. If the model that was developed in Autodesk Storm and Sanitary Analysis needs to be reviewed by a regulatory agency as an EPA SWMM model, you can quickly export out the necessary EPA SWMM input data file. However, those items that are not supported by EPA SWMM that are unique to Autodesk Storm and Sanitary Analysis are not exported.

Importing EPA SWMM Input Data Files

To import an EPA SWMM input data file:

- 1 If importing an EPA SWMM version 5.0 input data file, select **FILE** ► **IMPORT** ► **EPA SWMM v5.x FILE**.

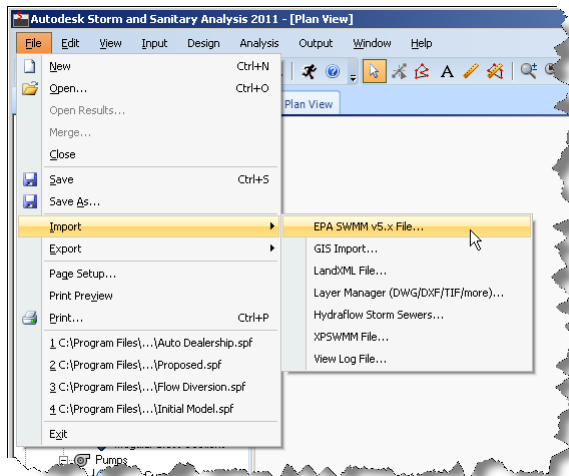

Figure 11.26 Select File ► Import ► EPA SWMM v5.x File

- 2 The Import EPA SWMM File dialog box is then displayed, allowing you to navigate to where the EPA SWMM input data file is. Select the EPA SWMM input data file and click Open.

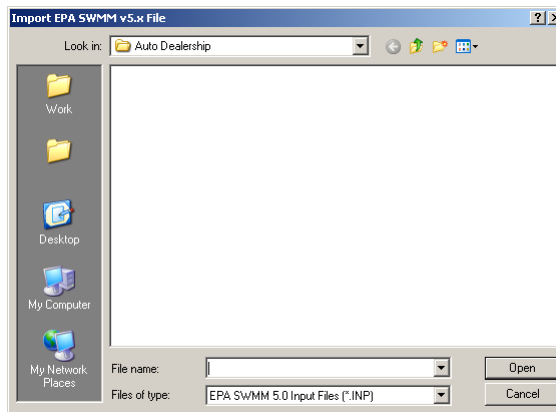

Figure 11.27 Select the EPA SWMM input file to import

- 3 The software will then begin the process of importing the EPA SWMM file. During the process, it displays a progress bar showing you the status of the import process. Generally importing an EPA SWMM model only takes a few seconds—depending upon the size of the network.
- 4 After the EPA SWMM model has been imported, you can then start to work on the network model using the software’s element editors, etc.

Exporting EPA SWMM Input Data Files

To export an EPA SWMM version 5.0 input data file of the currently loaded Autodesk Storm and Sanitary Analysis network model, follow the steps below. Note that the software will not export an EPA SWMM version 4.4 input file.

- 1 Select **FILE** ► **EXPORT** ► **EPA SWMM v5.x FILE**.

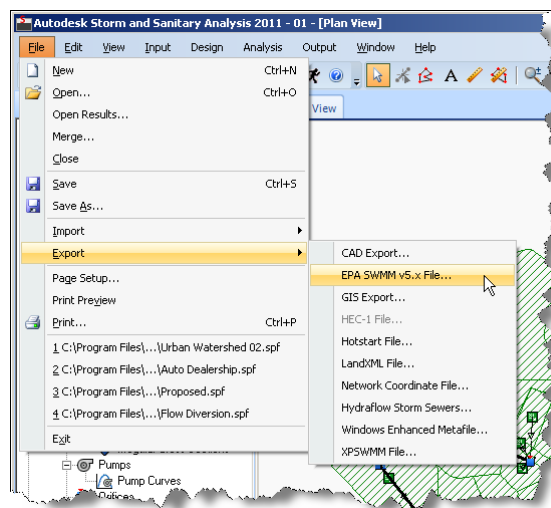

Figure 11.28 Select File ► Export ► EPA SWMM v5.x File

- 2 The Export EPA SWMM File dialog box is displayed, allowing you to navigate to where you want to save EPA SWMM input data file. Define the file name of the EPA SWMM file and click Save.

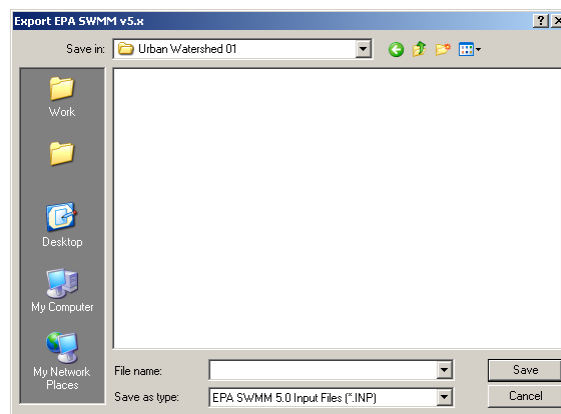

Figure 11.29 Define the file name of the EPA SWMM file to export

- 3 The software will then begin the process of exporting the EPA SWMM file. During the process, it displays a progress bar showing you the status of the export process. Generally exporting an EPA SWMM model only takes a few seconds—depending upon the size of the network.
- 4 Note that those items that are not supported by EPA SWMM that are unique to Autodesk Storm and Sanitary Analysis are not exported.

Importing & Exporting XPSWMM Input Data Files

Autodesk Storm and Sanitary Analysis provides you unparalleled modeling support for existing XPSWMM™ models. The software can import XPSWMM models, as well as export XPSWMM models. Any changes made to the model made in Autodesk Storm and Sanitary Analysis can be exported back to XPSWMM or analyzed. However, those items that are not supported by XPSWMM that are unique to Autodesk Storm and Sanitary Analysis are not exported.

Importing XPSWMM Input Data Files

To import a XPSWMM input data file:

- 1 Select **FILE** ► **IMPORT** ► **XPSWMM FILE**.

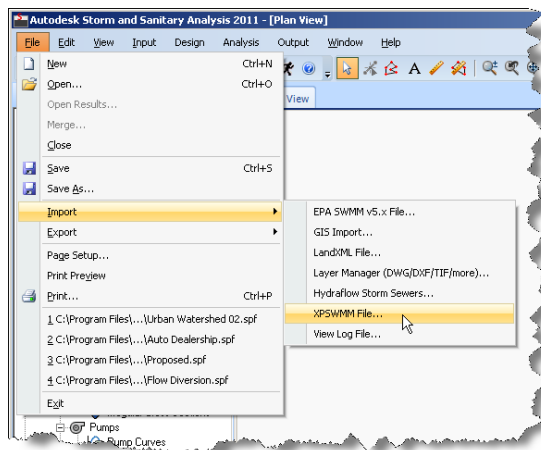

Figure 11.30 Select File ► Import ► XPSWMM File

- 2 The Import XPSWMM File dialog box is then displayed, allowing you to navigate to where the XPSWMM input data file is located. Select the XPSWMM input data file (it will have a file extension of **.XP**) and click Open.

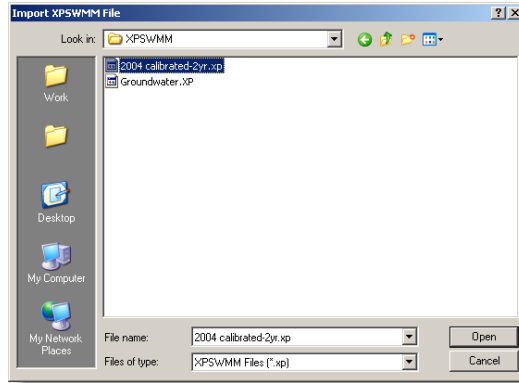

Figure 11.31 Select the XPSWMM input file to import

- 3 The software will then begin the process of importing the XPSWMM file. During the process, it displays a progress bar showing you the status of the import process. Generally importing a XPSWMM model only takes a few seconds—depending upon the size of the network.
- 4 After importing the XPSWMM model, the software will display a log file of the import process. This log file will describe where there may have been some translation problems in converting the XPSWMM model to Autodesk Storm and Sanitary Analysis. If at all possible, the software will attempt to resolve any conversion issues and inform you of these issues. However, this log file should be reviewed for any concerns that were identified.

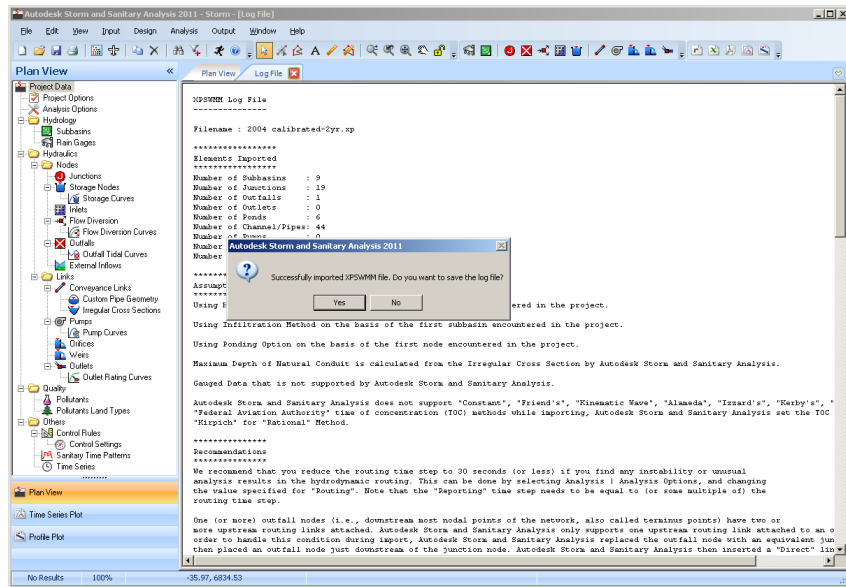

Figure 11.32 A log file is generated after importing the XPSWMM model, describing where there may have been some translation problems in converting the XPSWMM model to Autodesk Storm and Sanitary Analysis

- 5 After the XPSWMM model has been imported, you can then start to work on the network model using the software’s element editors, etc.

Exporting XPSWMM Input Data Files

To export a XPSWMM input data file of the currently loaded network model:

- 1 Select **FILE** ► **EXPORT** ► **XPSWMM FILE**.

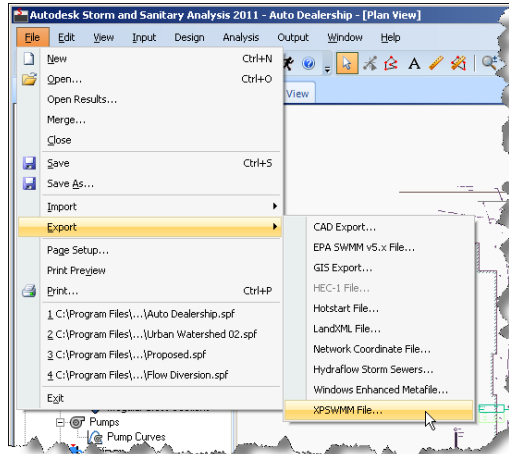

Figure 11.33 Select **File** ► **Export** ► **XPSWMM File**

- 2 The Export XPSWMM File dialog box is displayed, allowing you to navigate to where you want to save the XPSWMM input data file. Select the XPSWMM version you want to export using the **SAVE AS TYPE** drop-down list. Define the file name of the XPSWMM file and click **Save**.

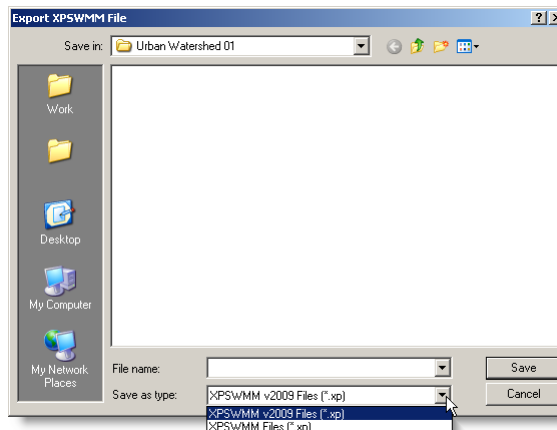

Figure 11.34 Define the file name of the XPSWMM file to export

- 3 The software will then begin the process of exporting the XPSWMM file. During the process, it displays a progress bar showing you the status of the export process. Generally exporting a XPSWMM model only takes a few seconds—depending upon the size of the network.
- 4 Note that those items that are not supported by XPSWMM that are unique to Autodesk Storm and Sanitary Analysis are not exported.

Exporting Network Coordinate Data

Autodesk Storm and Sanitary Analysis allows you to export network coordinate data as an ASCII text file. This file can then be used for other purposes, allowing you to easily check coordinates, etc.

To export the network model as a coordinate data ASCII file, select **FILE ► NETWORK COORDINATE FILE**. A Save As dialog box is displayed, allowing you to specify the name and the directory path (folder) for saving the file.

The exported network coordinate data is in an easily understandable format that can be easily processed or placed into Microsoft Excel. An example of this network coordinate file is shown in the following figure.

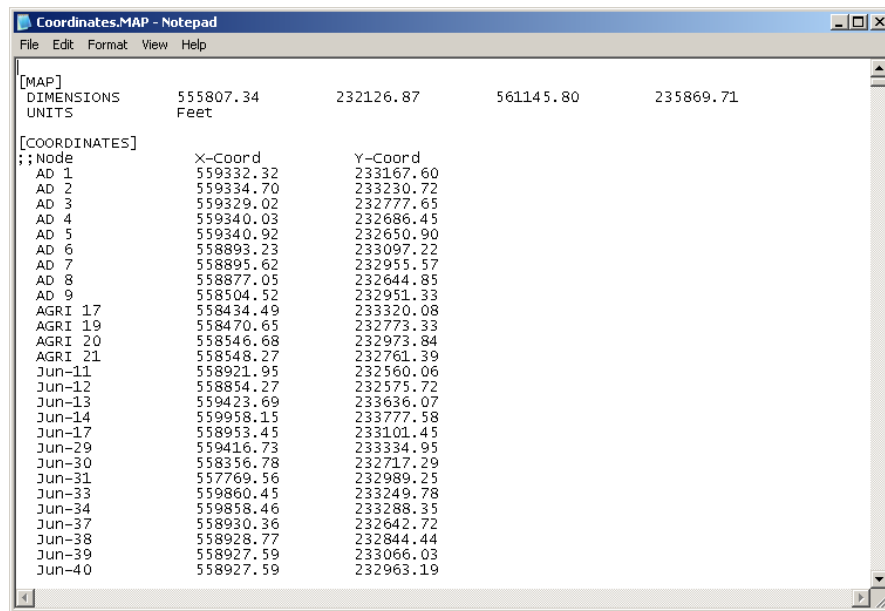

```
[MAP]
DIMENSIONS      555807.34      232126.87      561145.80      235869.71
UNITS          Feet

[COORDINATES]
;:Node          X-Coord          Y-Coord
AD 1            559332.32      233167.60
AD 2            559334.70      233230.72
AD 3            559329.02      232777.65
AD 4            559340.03      232686.45
AD 5            559340.92      232650.90
AD 6            558893.23      233097.22
AD 7            558895.62      232955.57
AD 8            558877.05      232644.85
AD 9            558504.52      232951.33
AGRI 17         558434.49      233320.08
AGRI 19         558470.65      232773.33
AGRI 20         558546.68      232973.84
AGRI 21         558548.27      232761.39
Jun-11         558921.95      232560.06
Jun-12         558854.27      232575.72
Jun-13         559423.69      233636.07
Jun-14         559958.15      233777.58
Jun-17         558953.45      233101.45
Jun-29         559416.73      233334.95
Jun-30         558356.78      232717.29
Jun-31         557769.56      232989.25
Jun-33         559860.45      233249.78
Jun-34         559858.46      233288.35
Jun-37         558930.36      232642.72
Jun-38         558928.77      232844.44
Jun-39         558927.59      233066.03
Jun-40         558927.59      232963.19
```

Figure 11.35 An example of the exported network coordinate data

Merging Network Models

Autodesk Storm and Sanitary Analysis has the ability to merge two or more separate network models into a single model. This allows you to break up a large project into separate sub-projects in order to expedite the model setup and development with additional staff.

In order to merge an external network model with the currently loaded network model, select **FILE ► MERGE**. The Merge dialog box is then displayed, as shown in the following figure. This dialog box allows you to specify how to handle element ID collisions, unlinked junctions, etc.

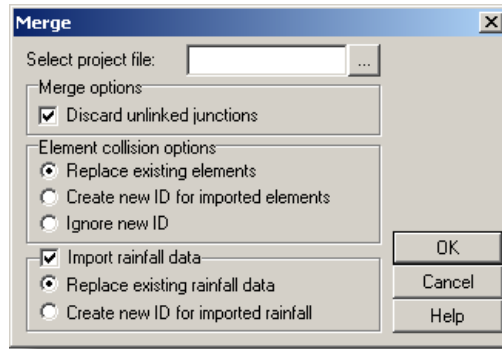

Figure 11.36 The software can merge two or more models into a single model, allowing you to break up a large project into separate sub-projects

Microsoft Excel Spreadsheets

Autodesk Storm and Sanitary Analysis can share data with Microsoft Excel, as described in the following sections.

Importing Excel Spreadsheet Data

You can paste data directly from Microsoft Excel into the software's dialog box tables. This allows you to easily copy and paste data with Excel and the software, providing maximum flexibility.

Exporting Excel Spreadsheets

The software can export its input data and analysis results directly to Microsoft Excel. This allows you maximum flexibility in customizing the output reports. Both the input data and the analysis results for the network elements will be exported to Excel. If the analysis has not yet been performed, then only the network element input data will be exported to Excel. See the section titled *Custom Reports* on page 116 and the section titled *Excel Table Reports* on page 120 for more information.

Index

A

- Additional flow capacity 200
- Additional losses 198
- Adjusting element elevations 67
- Aerial view 35
- Analysis
 - Analysis Options dialog box 69
 - Batch runs 76
 - Combining routing interface files 80
 - Continuity errors 87
 - Dates 71
 - Error messages 95–106
 - Hotstart file 75
 - Hydrodynamic analysis parameters 73
 - Inertial terms 73
 - Interface files 74
 - Lengthening time step 73
 - Multiple storm runs 76
 - Network layout errors 87
 - Performing an analysis 82
 - Rainfall interface file 74
 - RDII interface file 75
 - Routing interface file 76
 - Runoff interface file 75
 - Saving analysis results 84
 - Time steps 70
 - Troubleshooting 85
 - Typical problems encountered 86
 - Unstable flow routing errors 87
 - Variable time step 74
 - Warning messages 89–95
- Animation
 - Animation Recording Options dialog box 112
 - Display speed 111
 - Keyboard commands 111
 - Output Animation dialog box 110, 124
 - Recording to a file 112
 - Simulation date & time 122
 - Video frame rate 113
 - Video recording formats 112

- Antecedent Dry Days 72
- Arrows 28
- Ascending limb multiplier 168
- AutoCAD drawings
 - Exporting 125, 138, 473
 - Importing 12, 472
 - Layers 472
- Automatic backup files 19
- Automatic element labeling 180

B

- Background map image importing 474–475
- Backup files 19
- Batch runs 76
- Bend losses 197
- Breaking models into submodels 80

C

- Climatology
 - Areal depletion data 441
 - Climatology dialog box 437
 - Evaporation data 438
 - External climate file 442
 - Snow melt data 440
 - Temperature data 437
 - Wind speed data 439
- Combining routing interface files 80
- Composite spillways 315
- Configuration options 19
- Continuity errors 87
- Control rules
 - Action clauses 445
 - Condition clauses 444
 - Conditional rule examples 447
 - Control rule format 443
 - Control Rules dialog box 442
 - Control Settings dialog box 448
 - Controllable outlets 302

- Gates and valves 298
- Inflatable weirs and rubber dams 315
- Modulated controls 445
- PID controllers 446
- Real time controls 446
- Controllable gates and valves 298
- Converting network elements 53
- Conveyance Links dialog box 188
- Copying and pasting element properties 55
- Culvert computations 188, 205
- Custom pipe geometry 191, 210
- Custom reports 116

D

- Data tree 14
- Defining a network 40
- Deleting multiple elements 66
- Design flow capacity 199
- Detention ponds
 - Computing storage volumes 149
 - Estimating first flush volume 281
 - Exfiltration data 273
 - Exfiltration methods 176
 - Invert elevation 271
 - Max flooded overflow 277
 - Max water depth 277
 - Max water elevation 277
 - Maximum elevation 271
 - Minimum drain time 279
 - Peak inflow 277
 - Storage curves 281
 - Storage Nodes dialog box 269
 - Storage shape data 272
 - Total flooded volume 277
 - Total time flooded 277
- Dimensionless unit hydrograph 421
- Directional arrows 28
- Display options 25
- Duplicating network elements 55

E

- Editing multiple elements 64
- Element ID labels 180
- Element prototypes 182
- Entrance losses 197
- EPA SWMM
 - File exporting 490
 - File importing 489
 - Hydrology description 353
 - Infiltration methods 169
 - Skip steady state time periods 177
 - Subbasins dialog box 343
 - Time of concentration 351

- Error messages 95–106
- Exit losses 197
- Exporting
 - AutoCAD drawings 125, 138, 473
 - EPA SWMM data 490
 - GIS data 486–488
 - HEC-1 input data files 386
 - Hydraflow export considerations 480
 - Hydraflow Storm Sewers files 479–480
 - LandXML files 482
 - Microsoft Excel spreadsheet data 495
 - Microsoft Windows graphic metafiles 475
 - Network coordinate data 494
 - XPSWMM data 493
- External inflows 217, 237, 250, 257
 - Dry weather (sanitary) inflows 404, 410
 - External Inflows dialog box 402
 - External Inflows for Node dialog box 408
 - User-defined (direct) inflows 403, 409

F

- FHWA culvert computations 188, 205
- Finding network elements 61
- Flow diversions
 - External inflows 250
 - Flow Diversions dialog box 248
 - Initial WSEL 250
 - Invert elevation 250
 - Maximum elevation 250
 - Performance curves 253
 - Ponded area 250
 - Structure design 252
 - Surcharge elevation 250
- Flow units 166
- Force mains 175

G

- GIS
 - Attribute mapping 484, 488
 - Export Wizard 486–488
 - Import Wizard 483–486
- Groundwater
 - Groundwater Aquifer Assignment dialog box 428
 - Groundwater Aquifers dialog box 426

H

- Head losses 197, 198
- HEC-1
 - Clark unit hydrograph method 369
 - Exponential loss method 363

- Exporting HEC-1 input data files 386
 - Flood routing 386
 - Green Ampt loss method 365
 - Holtan loss method 367
 - Hydrology method 355
 - Kinematic Wave method 379
 - Loss methods 172
 - SCS curve number loss method 361
 - SCS dimensionless unit hydrograph method 375
 - Snyder unit hydrograph method 376
 - Uniform loss method 360
 - Unit hydrograph methods 171
 - User defined unit hydrograph method 377
 - Hotstart file 75
 - Hydraflow Storm Sewers
 - Export considerations 480
 - File exporting 479–480
 - File importing 476–478
 - Import considerations 478
 - Hydrodynamic
 - Analysis parameters 73
 - Hydrodynamic routing method 174
 - Hydrology method
 - Available methods 166
 - Method limitations 178
- I**
- ID labels 180
 - IDF curves
 - Default data 401
 - IDF Curves dialog box 398
 - Rainfall equation 399
 - Return period 401
 - Storm duration 400
 - Importing
 - AutoCAD drawing layers 472
 - AutoCAD drawings 12, 472
 - Background map images 474–475
 - EPA SWMM data 489
 - GIS data 483–486
 - Hydraflow import considerations 478
 - Hydraflow Storm Sewers files 476–478
 - LandXML files 481
 - Merging network models 494
 - Microsoft Excel spreadsheet data 495
 - Orthophoto images 474–475
 - XPSWMM data 491
 - Inertial terms 73
 - Inlets
 - Combination inlet type 235
 - Default structure height 185
 - Default sump depth 184
 - Design storm 241
 - External inflows 237
 - Gutter flow depth 240
 - Gutter spread 240
 - Gutter spread warning 185
 - Hydraulic performance curves 240
 - Hydraulics 227
 - Inlet efficiency 240
 - Inlet location 234
 - Inlet sizing, spacing, and locating 243
 - Inlet type 234
 - Inlets dialog box 231
 - Manufacturer 233
 - Peak flow bypassing inlet 240
 - Peak flow during analysis 239
 - Peak flow intercepted by inlet 239
 - Roadway/gutter bypass link 237
 - Types 225
 - Upstream roadway links 238
 - Irregular cross sections 211
- J**
- Junction losses 201
 - Junctions
 - Automatically assigning invert elevations 218
 - Default structure height 183
 - Default sump depth 183
 - External inflows 217, 402
 - Head losses 221
 - Initial WSEL 217
 - Invert elevation 217
 - Junctions dialog box 214
 - Max flooded overflow 219
 - Max water depth 219
 - Max water elevation 219
 - Max/rim elevation 217
 - Peak inflow 219
 - Ponded area 217
 - Surcharge elevation 217
 - Surface area 74
 - Total flooded volume 219
 - Total time flooded 219
- K**
- Kinematic wave routing method 174
- L**
- LandXML files
 - Exporting 482
 - Importing 481

- Layer manager 474
- Lengthening time step 73
- Loading previous analysis results 108
- Lock coordinates 15, 21, 24
- Locking the network 15, 21, 24
- Long sections
 - Animation 136
 - Creating 125
 - Customizing 132
 - Defining a path 126
 - EGL computation 139
 - Exporting AutoCAD drawing 138
 - Loading a path 130
 - Printing 137
 - Right-click context menu 131
 - Saving a path 129
 - Summary table 133

M

- Manholes
 - Automatically assigning invert elevations 218
 - Bolted (sealed) manhole covers 224
 - Default structure height 183
 - Default sump depth 183
 - External inflows 402
 - Head losses 221
 - Initial WSEL 217
 - Invert elevation 217
 - Junctions dialog box 214
 - Max flooded overflow 219
 - Max water depth 219
 - Max water elevation 219
 - Max/rim elevation 217
 - Minimizing flow turbulence 222
 - Peak inflow 219
 - Ponded area 217
 - Spacing of manholes 220
 - Surcharge elevation 217
 - Total flooded volume 219
 - Total time flooded 219
- Merging network models 494
- Microsoft Excel table reports 120
- Minimum conduit slope 175
- Modified rational method storm duration 167
- Multiple storm simulations 76

N

- Network layout errors 87
- Network transformation 67
- Node coordinates 52

O

- Open channels 190, 211
- Orifices
 - Discharge coefficients 297
 - Flap gate 296
 - Flow reversals 298
 - Open/close time 296
 - Orifices dialog box 294
 - Peak flow 297
 - Shape 296
 - Time of max occurrence 297
 - Type 296
- Orthophoto image importing 474–475
- Other losses 198
- Outfalls
 - External inflows 257
 - Outfalls dialog box 255
 - Tidal curves 258
- Outlets
 - Flap gate 300
 - Outlet rating curves 304
 - Outlets dialog box 299
 - Peak flow 302
 - Tailwater submergence effects 302
 - Time of max occurrence 302
 - Types 300
 - Vortex flow control devices 302
- Output
 - Animation 110
 - ASCII output report 113
 - ASCII report bookmark navigation 114
 - ASCII report sections 114
 - Comparing different simulations 146
 - Computing storage volumes 149
 - Custom reports 116
 - Dialog box display 109
 - Element time series table 156
 - Flyover property mapping 122
 - Generating a custom report 119
 - Loading a custom report template 119
 - Loading analysis results file 108
 - Long sections 125
 - Microsoft Excel table reports 120
 - Output variables 107
 - Printing plan view 125
 - Profile plots 125
 - Recording animations 112
 - Saving a custom report template 119
 - Simulation date & time 122
 - Statistical reports 160
 - Time series plots 140
 - Variable time series table 156

P

- Peak flow during analysis 200
- Performing an analysis 82
- Pipe shapes, supported 190
- Pipes
 - Additional flow capacity 200
 - Additional losses 198
 - Adverse slope 209
 - Automated assignment of invert elevations 207
 - Available pipe shapes 190
 - Bend losses 197
 - Constructed slope 199
 - Conveyance Links dialog box 188
 - Custom pipe geometry 191, 210
 - Darcy-Weisbach roughness height 195
 - Design flow capacity 199
 - Entrance losses 197
 - Exit losses 197
 - Flap gates 197
 - Hazen-Williams C-factor 195
 - Inlet invert elevation 196
 - Manning's roughness 196
 - Max/design flow ratio 201
 - Max/total depth ratio 201
 - Maximum flow (optional) 198
 - Maximum pipe cover 208
 - Maximum pipe runs 209
 - Maximum velocity attained 200
 - Minimum flow velocity 208
 - Minimum pipe cover 208
 - Minimum pipe grade 208
 - Outlet invert elevation 196
 - Peak flow during analysis 200
 - Sewer pipe alignment 209
 - Surcharging pipes and oscillations 210
 - Total time surcharged 201
- Plan view
 - Annotation 29
 - Background color 29
 - Color coded 29
 - Defining a link 44
 - Defining a node 43
 - Defining a subbasin 42
 - Deleting multiple elements 66
 - Directional arrows 28
 - Display flooding 27, 28
 - Display Options dialog box 25
 - Display surcharging 27, 28
 - Editing multiple elements 64
 - Element properties display 29
 - Finding elements 61
 - Flyover property labeling 122
 - Hiding a rain gage 48
 - Legends display 31
 - Links display 27
 - Map labels 49
 - Network scaling and shifting 67
 - Nodes display 27
 - Printing 125
 - Property mapping 120
 - Querying elements 62
 - Right-click context menu 34
 - Simulation date & time 122
 - Subbasins display 26
 - Symbols 28
 - Vertice editing 57
- Pollutants
 - BMP efficiency 459
 - Cleaning efficiency 459
 - Co-fraction 452
 - Concentration in rain water 451
 - Concentration units 451
 - Co-pollutant 452
 - Decay coefficient 452
 - Inflows & infiltration 452
 - Initial Pollutants dialog box 461
 - Land types 453
 - Pollutant buildup 455
 - Pollutant Land Type Assignment dialog box 460
 - Pollutant Treatments dialog box 462
 - Pollutant washoff 457
 - Pollutants dialog box 450
 - Pollutants Land Types dialog box 453
 - Snow melt 452
 - Street sweeping 72, 454
 - TSS removal example 464
- Profile plots
 - Animation 136
 - Creating 125
 - Customizing 132
 - Defining a path 126
 - EGL computation 139
 - Exporting AutoCAD drawing 138
 - Loading a path 130
 - Printing 137
 - Right-click context menu 131
 - Saving a path 129
 - Summary table 133
- Program configuration 19
- Project Description dialog box 163
- Project options
 - Flow units 166
 - Hydrology method 166
 - Project Options dialog box 163
 - Storm duration 167
 - Time of concentration method 167
 - Unit system 165
- Prototypes, elements 182
- Pumps

- Control rules 264
- Operational control 264
- Performance curves 264
- Pump design 262
- Pump mode 262
- Pump type 263
- Pumps dialog box 260

Q

- Querying network elements 62

R

- Rain gages
 - Defining 46
 - Directly assigning storm precipitation 391
 - Displaying a hidden gage 47
 - External rainfall file format 392
 - External rainfall files 391
 - Hiding a rain gage 48
 - Increment interval 390
 - Rain data type 390
 - Rain Gages dialog box 46, 388
 - Rational Method, Modified Rational, DeKalb Rational Methods 391
 - SCSTR-55 & SCS TR-20 hydrology methods 391
 - Snow correction factor 390
- Rainfall Designer 5, 392–395
 - Huff rainfall distributions 397
 - SCS rainfall distributions 395
- Rainfall file format 392
- Rainfall interface file 74
- RDII
 - External Inflows dialog box 402
 - File format 82
 - Initial abstraction 414
 - Interface file 75
 - Parameter determination and calibration 416
 - RDII unit hydrograph 403, 409, 411
 - RTK unit hydrograph 414
 - Sewershed area 403, 409
 - Sources of RDII 415
- Receding limb multiplier 169
- Reporting time step 70
- Reports
 - ASCII report bookmark navigation 114
 - ASCII report sections 114
 - ASCII reports 113
 - ASCII reports, include control actions 178
 - ASCII reports, include input data 177
 - Custom 116
 - Generating a custom report 119

- Loading a custom report template 119
- Microsoft Excel table reports 120
- Saving a custom report template 119

- Reversing element direction 59
- Routing file format 82
- Routing interface file 76
- Routing methods 174
- Routing time step 70
- Runoff interface file 75
- Runoff time step 70

S

- Sanitary sewers
 - Average daily flows 405
 - Bolted (sealed) manhole covers 224
 - External inflows 217, 250, 257
 - Flow diversion structures 246
 - Force main equation 175
 - Force main pipe shape 188
 - Maximum pipe cover 208
 - Minimum flow velocity 208
 - Minimum pipe cover 208
 - Minimum pipe grade 208
 - Pumps 260
 - Sanitary time patterns 464
 - Sewer pipe alignment 209
 - Unit multiplier 466
- Saving analysis results 84
- Schematic network representation 42
- SCS TR-20
 - Dimensionless unit hydrograph 421
 - Minimum drainage area 321
- SCS TR-55
 - Curve numbers 328
 - Editing curve number table 330
 - Minimum drainage area 321
- Simulation
 - Analysis Options dialog box 69
 - Batch runs 76
 - Combining routing interface files 80
 - Continuity errors 87
 - Dates 71
 - Error messages 95–106
 - Hotstart file 75
 - Hydrodynamic analysis parameters 73
 - Inertial terms 73
 - Interface files 74
 - Lengthening time step 73
 - Multiple storm runs 76
 - Network layout errors 87
 - Performing an analysis 82
 - Rainfall interface file 74
 - RDII interface file 75
 - Routing interface file 76

- Runoff interface file 75
 - Saving analysis results 84
 - Time steps 70
 - Troubleshooting 85
 - Typical problems encountered 86
 - Unstable flow routing errors 87
 - Variable time step 74
 - Warning messages 89–95
 - Snow
 - Simulation of snow melt 431
 - Snow Packs dialog box 432
 - Spillways
 - Composite spillway structures 315
 - Contraction type 312
 - Discharge coefficient 312
 - Inflatable weirs and rubber dams 315
 - Peak flow 314
 - Submerged flow 314
 - Time of max occurrence 314
 - Type 311
 - Weirs dialog box 307
 - Statistical reports 160
 - Steady flow routing method 175
 - Storage chambers 288
 - Storage nodes
 - Estimating first flush volume 281
 - Exfiltration data 273
 - Exfiltration methods 176
 - Invert elevation 271
 - Max flooded overflow 277
 - Max water depth 277
 - Max water elevation 277
 - Maximum elevation 271
 - Minimum drain time 279
 - Peak inflow 277
 - Storage curves 281
 - Storage Nodes dialog box 269
 - Storage shape data 272
 - Total flooded volume 277
 - Total time flooded 277
 - Storage vaults 220, 271
 - Storm drain inlets
 - Combination inlet type 235
 - Default structure height 185
 - Default sump depth 184
 - Design storm 241
 - Gutter flow depth 240
 - Gutter spread 240
 - Gutter spread warning 185
 - Hydraulic performance curves 240
 - Hydraulics 227
 - Inlet efficiency 240
 - Inlet location 234
 - Inlet sizing, spacing, and locating 243
 - Inlet type 234
 - Inlets dialog box 231
 - Manufacturer 233
 - Peak flow bypassing inlet 240
 - Peak flow during analysis 239
 - Peak flow intercepted by inlet 239
 - Roadway/gutter bypass link 237
 - Types 225
 - Upstream roadway links 238
 - Subbasins
 - Accumulated precipitation 327
 - Area 321
 - Area units 183
 - Editing curve number table 330
 - Editing runoff coefficient table 333
 - EPA SWMM hydrology method 343
 - Equivalent width 321
 - HEC-1 hydrology method 355
 - Minimum drainage areas 321
 - Outlet node (or subbasin) 320
 - Peak runoff 328
 - Rain gage 320
 - Rainfall intensity 328
 - Runoff coefficients 331
 - SCS TR-55 curve numbers 328
 - Subbasin delineation 387
 - Subbasins dialog box 318
 - Time of concentration 324
 - Total infiltration 328
 - Total precipitation 328
 - Total runoff 328
- ## T
- Tidal curves 258
 - Time of concentration methods 167
 - Time series
 - Exporting data 469
 - External file format 470
 - Extrapolation of data 469
 - Importing data 469
 - Microsoft Excel, editing of data 469
 - Rainfall data 468
 - Time & date formats 468
 - Time Series dialog box 467
 - Time series plots 140
 - Comparing different simulations 146
 - Computing storage volumes 149
 - Creating a plot 143
 - Customization 154
 - Data table 151
 - Displaying multiple plots 145
 - Legend location 154
 - Output variable tree 140
 - Printing 155
 - Right-click context menu 153
 - Summary table 148

- Time series table
 - Element table 156
 - Printing 159
 - Variable table 156
- Time steps 70
- Toolbars
 - Elements 24
 - Map 21
 - Output 25
 - Standard 20
- TR-20
 - Dimensionless unit hydrograph 421
 - Minimum drainage area 321
- TR-55
 - Minimum drainage area 321
- Transform Network dialog box 67
- Troubleshooting a model 85, 210
- TSS removal example 464

U

- Underground storage arch pipes 286
- Underground storage chambers 288
- Underground storage pipes 284
- Unlock coordinates 15, 21, 24
- Unlocking the network 15, 21, 24
- Unstable flow routing errors 87

V

- Valves 298
- Variable time step 74
- Vertice editing 21, 57
- Vortex flow control devices 302

W

- Warning messages 89–95
- Wastewater sewers
 - Average daily flows 405
 - Bolted (sealed) manhole covers 224
 - External inflows 217, 250, 257
 - Flow diversion structures 246
 - Force main equation 175
 - Force main pipe shape 188
 - Maximum pipe cover 208

- Minimum flow velocity 208
- Minimum pipe cover 208
- Minimum pipe grade 208
- Pumps 260
- Sanitary time patterns 464
- Sewer pipe alignment 209
- Unit multiplier 466
- Water quality
 - BMP efficiency 459
 - Cleaning efficiency 459
 - Co-fraction 452
 - Concentration units 451
 - Co-pollutant 452
 - Decay coefficient 452
 - Inflows & infiltration 452
 - Initial Pollutants dialog box 461
 - Land types 453
 - Pollutant buildup 455
 - Pollutant Land Type Assignment dialog box 460
 - Pollutant Treatments dialog box 462
 - Pollutant washoff 457
 - Pollutants dialog box 450
 - Pollutants Land Types dialog box 453
 - Rain water 451
 - Snow melt 452
 - Street sweeping 72, 454
 - TSS removal example 464

Weirs

- Composite weir structures 315
- Contraction type 312
- Discharge coefficient 312
- Inflatable weirs and rubber dams 315
- Peak flow 314
- Submerged flow 314
- Time of max occurrence 314
- Type 311
- Weirs dialog box 307

X

- XPSWMM
 - Data exporting 493
 - Data importing 491
 - Import log file 492
 - Troubleshooting models 492